

dams



FURNITURE GUIDE

2025

CONTENTS



ACOUSTIC
PODS

12



DESKS
CONTENTS

20



HEIGHT ADJUSTABLE
DESKS

22



BENCH
DESKS

32



CABLE MANAGED
DESKS

56



STEEL
STORAGE

140



DESK & FLOOR
SCREENS

156



PIANO
ACOUSTICS

170



OFFICE
ACCESSORIES

178



POWER &
DATA

188



COFFEE & SIDE
TABLES

256



RECEPTION
UNITS

264



SEATING
INTRO

272



STOCKED
SEATING

278



STOCKED
TRIPLE P

280



STOCKED
MULTI-PURPOSE

336



STOCKED
SOFT SEATING

346



MTO
SEATING

360



MTO
TASK CHAIRS

382



MTO
MULTI-PURPOSE

396



CONTRACT DESKS

70



EXECUTIVE DESKS

94



HOME OFFICE

100



WOODEN STORAGE

108



MODULAR STORAGE

126



TABLES CONTENTS

198



COLLABORATIVE WORKTABLES

200



BOARDROOM TABLES

208



MODULAR TABLES

226



CAFE & DINNING TABLES

240



STOCKED MESH TASK

286



STOCKED MESH OPERATOR

296



STOCKED FABRIC TASK

306



STOCKED LEATHER

316



STOCKED MEETING

328



MTO SOFT SEATING

426



MTO MEETING BOOTHS

464



MFC & FABRICS

472



We've Got You Covered.

We are both a manufacturer and a wholesaler of office furniture. Because we are both, we are uniquely placed to help support your growth in the office interiors sector.

Our warehouses allow us to keep over 11,000 stocked items ready for your customers, and our large scale manufacturing capabilities means we can make what you want, when you want it – and no later.

*Supporting
Dealers
Since 1967.*



We're Not Going Anywhere.

You're In Good Hands.

We weren't born yesterday – we have been a family-owned, proudly Liverpool-based company since 1967.

We are here to serve you, and to share with you our wisdom that has been passed down through the decades, feeding a wealth of industry experience that has fuelled growth and success over many years.

We Set The Bar High.

We're committed to excellence in every aspect of our business, and regularly take on external assessments and certifications in order to ensure we're doing it right.

This includes rigorous testing of our products and procedures to make sure they meet the highest standards.

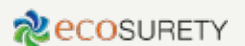

FSC® certified products available on request

We're The Manufacturer.

Dams boasts one of the largest and most highly automated office furniture factories in Europe, manufacturing our wooden furniture products right here in the UK. This provides you with unparalleled flexibility to respond swiftly to demand, combined with an unparalleled depth of range.

These quality-assured products can be traced all the way back to their roots. Certifications from industry-leading organisations, including FISP and FSC, provide your customers with reassurance of our commitment to being a sustainable manufacturer.



*We're
Expert
Craftspeople*

*115,000 Metres
Of Fabric Cut
Per Year*

*2 Million
Panels Cut
Per Year*

We Also Wholesale.

As a wholesaler, we scour the globe so you don't have to, strengthening our portfolio with the best products that the world has to offer.

We work with selected partners to ensure consistent quality, reliability and stock availability, and we use innovative software to work together seamlessly and efficiently.

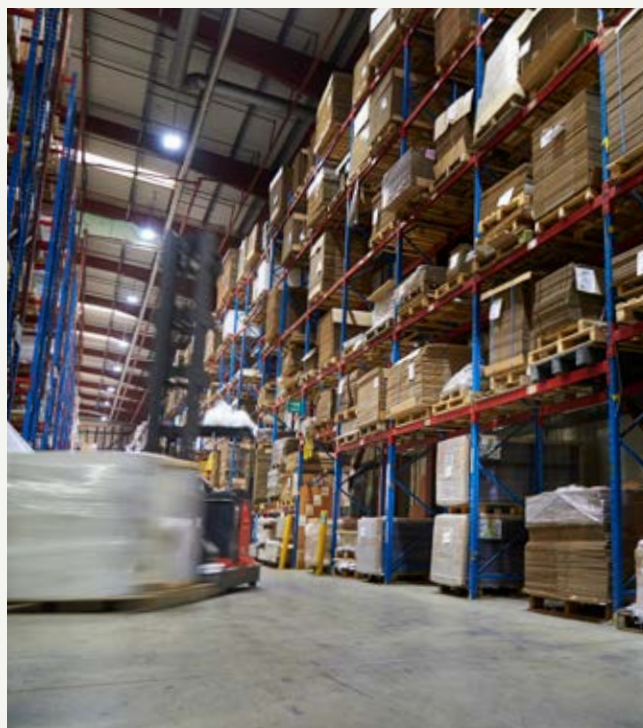

We're proud of what we do.

100%
Electricity
from green
sources,
17% solar



47% staff
are from
5 miles of
Dams



100% of Dams
employees are
provided with
healthcare
benefits



Zero waste
to land fill



Operating
both electric
and HVO
powered
vans



All wood
waste goes
through
biomass boiler
for heating



Sponsoring
10 grass
roots junior
football
teams



Continued
annual
investment in
people and
process



Raising over
£150k for
local and
national
charities



400%
increase
in Re.think
furniture
recycling
service



91% of
Suppliers
based in UK,
with £5m from
< 50 miles



65%
reduction in
CO2 per unit
since 2020



Sustainable
product
design



13 mental
health
trained first
aiders



Working
with local
schools





We Come To You, Or Come To Us.

We can deliver to your warehouse twice a week, with no minimum order value and no delivery charge. Take advantage of a late 4pm cut-off time, established to ensure you can offer your customer a quick, reliable delivery service - no matter where you are based in the UK.

If you don't have a warehouse, you can arrange to collect from one of the seven strategically located collection centres we have across the UK.

re.think.

Like many, we are hot on sustainability. Unlike many, we provide a complete, sustainable waste management service on top of everything else

Through re.think, we recycle or reuse both waste packaging and old office furniture, regardless if it belonged to us originally - because we don't want to just reduce our own carbon footprint, but yours too.

Re.think provides our customers with an easy-to-access, hassle-free, and low-cost way to dispose of waste; we handle collection, processing, and sustainable disposal, so –our dealers' hands can be free to handle everything else.



We Go The Extra Mile.

Dams is leading the pack in end user deliveries.

Our “2-Person Delivery” service offers a 2-4 day lead time – however, if you are looking for a next-day delivery, or delivery on a specific day, we offer a “Premium 2-Person Delivery” service.

Both delivery services are carried out by a dedicated 2-person delivery team, direct to your customer’s room of choice. The deliveries are pre-booked and include a 1-hour pre call.



If you are looking for a simple solution, our “Express Delivery” is a drop-ship service, where goods are placed appropriately at your customer’s kerb side.

Our Premium Service has a later cut-off of 3pm, and 4pm for our Express Service – for maximum convenience.

For even more convenience, we can also support your customers with a full furniture recycling service of old unwanted furniture.

We Do The Heavy Lifting.

Give your customers the red-carpet treatment by offering a complete, white-glove end user installation service.

We can offer a 5-7 day “White Glove Install” service or, for those installations that require perfect timing, you can upgrade to a “Premium White Glove Install” and simply name your day (from 48 hours following order receipt).

Our expert installation teams are intricately trained to install and set out your



customers new office furniture, with the utmost care and attention.

For larger installations, take advantage of our internal project management team, who can coordinate everything from a site survey and risk assessment to overseeing the final installation details.

We Bring You Innovation By Design.

Combining the expertise of our in-house team of designers and a selection of external designers around the globe, we develop innovative new products every year.

The crucial aspects of quality, sustainability, and ergonomics are intricately balanced with the latest trends in design and workplace culture, to create products perfect for any space, anywhere.

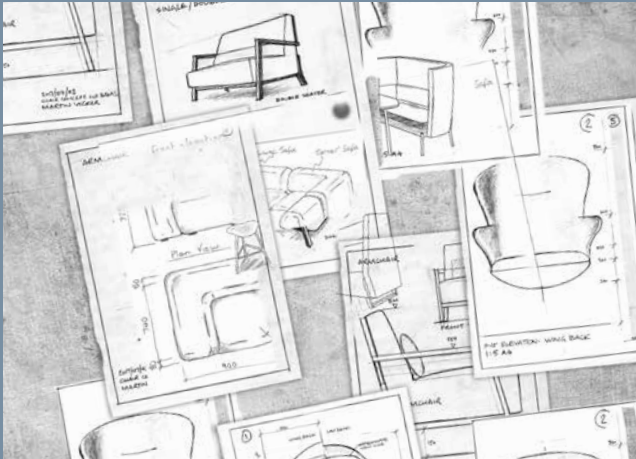

We Design Inspiring Spaces.

We'll do more than just provide your furniture – our expert in-house team of interior designers will bring your space to life.

Utilising current, high-end space planning software, and incorporating our in depth knowledge of workplace trends, the team can create your customer's dream interior.



We Help You Sell More.

We get it, selling yourself can be hard.

That's why we provide a comprehensive library of marketing literature, both digital and print, that you can put your own stamp on. This library contains annual furniture guides, 16-page 6-monthly specialised focus catalogues, quarterly flyers, as well as 100s of product flyers for you to personalise and take home – no library card required.

Knowledge is power, and there's no better power source than our online customer portal, MyDams. As our partner, you have an all-access pass to stock checks, quotation tools, marketing materials, order updates, data files, and much much more – 24/7, 365 days a year (366 on leap years).



We'll Make Your Life A Whole Lot Easier.

To provide the best service and make your business lives easier, we have partnered with the world's leading providers of office product software.

Our enhanced, industry-leading data is created for easy access, to support your sales. Browse over 11,000 products and prices, receive up-to-date stock feeds, and place and acknowledge orders via EDI.



New for 2025



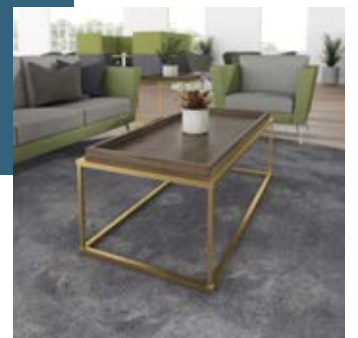
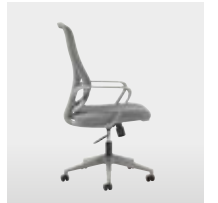
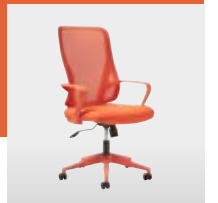

ACOUSTIC HUBS

WORKING WITHIN YOUR COMFORT ZONE

SINGLE HUBS



RETREAT BOX
14



CHATBOX SINGLE
15



CHATBOX SOLO
16

DUO HUBS



CHATBOX DUO
17

QUATTRO HUBS



CHATBOX QUATTRO
18

ACCESSORIES



ACCESSORIES
19

Retreat | Single



Specification

Internal Dimensions

895 w

2100 h

905 d

Weight

KG 304kg

Sound Insulation

33dB

Air Circulation

More than 33 L/S

Power

UK socket & USB



CODE	W	D	H	RRP
RBX-1	1000	1000	2360	£5000

Minimalistic, modern and timeless design Retreat box creates the perfect environment to break away for the distractions and noise from busy workspaces. The single person pod is ideal for take and receive phone call when privacy is required. Stylish black exterior finish with contrasting oak trim add to Retreats appeal.

Includes work area along with power and USB A & C charging points

Ideal for making or receiving private calls where undisturbed work is required

60mm thick walls with MFC, foam and finished in acoustic felt for superior quality

LED lighting, quiet fan and 3-meter mains cable ready for use



STOCKED



Black (K)



CHATBOX BY SILEN

Specification

Internal Dimensions

870 w

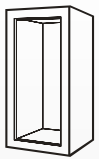

2040 h

980 d

Weight



300kg

Sound Insulation



34dB

Air Circulation



More than 22 L/S

Power



UK socket & USB



The Chatbox telephone booth, designed by industry-leading acoustic experts, offers a peaceful environment for one person to take calls away from distractions. Its sleek, modern design ensures durability while providing privacy. LED interior lighting along with an all-black stocked exterior

Everything you need for a private conversation or a space to focus on your own

Supplied with shelf with optional whiteboard and tv bracket

Supplied complete with shelf work area. Optional whiteboard and tv bracket available

Silent ventilation and a fresh indoor climate to support a focused mind

CODE	DESCRIPTION	W	D	H	STOCKED	MTO
CBX-1	Phone booth	1000	1000	2227	£11,225	£12,500



STOCKED



Black (K)

5-6 week lead time



White (WH)



Cotton (CT)



Opal (OP)



Myosotis (MY)



Paprika (PP)



Storm Grey (SG)



Frozen Blue (FB)

Please add exterior finish when ordering eg. CBX-1 in Black = CBX-1-K



CHATBOX BY SILEN

Specification

Internal Dimensions

1130 w

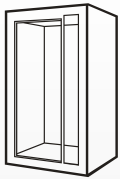

2040 h

910 d

Weight



380kg

Sound Insulation



34dB

Air Circulation



More than 55 L/S

Power



UK socket & USB



CODE	W	D	H	MTO
CBX-S1	1250	980	2220	£16500

Chatbox Solo is perfect for those times when a basic phone booth feels too cramped for serious work. The additional space creates more room for focused activities keeping the outside distractions at bay for longer. LED interior lighting along with an all-black stocked exterior create an elegant looking hub

Supplied complete with desk work area. Optional whiteboard and tv bracket available

Ideal for focus working, supplied in a choice of 8 colours to match your corporate identity

Recycled echo-free fabric and carpet for superior soundproofing

Silent ventilation and fresh indoor climate to support a focused mind



MTO

5-6 week lead time



Black (K)



White (WH)



Cotton (CT)



Opal (OP)



Myosotis (MY)



Paprika (PP)



Storm Grey (SG)



Frozen Blue (FB)



Grey interior fabric

Please add exterior finish when ordering eg. **CBX-2** in White = **CBX-2-WH**



CHATBOX BY SILEN

Specification

Internal Dimensions

2000 w

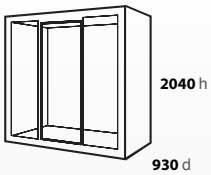

Weight

KG 550kg

Sound Insulation

34dB

Air Circulation

More than 55 L/S

Power

UK socket & USB



Chatbox Duo creates a private meeting room instantly, promoting connection and collaboration. This multifunctional space supports creativity, making the office inviting and enjoyable for all, and allowing employees to work according to their own needs and preferences.

Perfect for 1-1 meetings and small brainstorm sessions in comfort and silence

Handle on left or right hand side with 8mm thick glass for superior acoustic quality

High-quality design with abundant natural LED light with a low power consumption

Easy to assemble with black and white sheet metal exterior options

CODE	W	D	H	MTO
CBX-2	2130	1030	2227	£22,700



MTO

5-6 week lead time

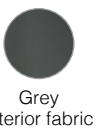

Please add exterior finish when ordering eg. **CBX-2** in White = **CBX-2-WH**



CHATBOX BY SILEN

Specification

Internal Dimensions

2000 w

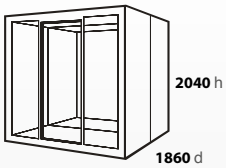

Weight

KG 980kg

Sound Insulation

34dB

Air Circulation

More than 85 L/S

Power

UK socket & USB



Chatbox Quattro accommodates four to six people, ideal for brainstorming or meetings requiring collaboration. Its design includes various furniture options to enhance functionality and maximise interior space. LED interior lighting along with an all-black stocked exterior create an elegant looking hub

A private space for meetings in the middle of an open plan office

Choice of 8 external colours to match your corporate identity

Recycled echo-free grey fabric and carpet for superior soundproofing

Silent ventilation and a fresh indoor climate to support a focused mind

CODE	W	D	H	MTO
CBX-4	2130	1940	2220	£35,000



MTO

5-6 week lead time



Please add exterior finish when ordering eg. **CBX-4** in Black = **CBX-4-K**

Slatted Oak Veneer Panel

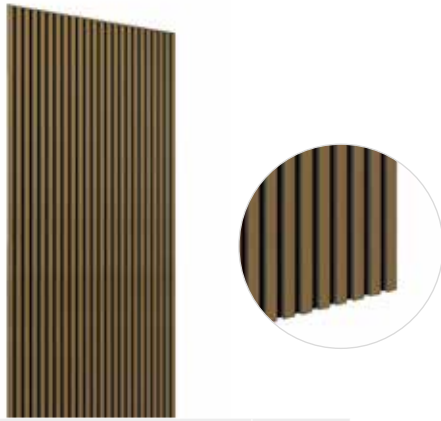

CODE	DESCRIPTION	RRP
CBX-SWS	Slatted Oak for Single and Solo	£2500
CBX-SWE	Slatted Oak for Duo and Quattro	£3250

- Manufactured in oak veneer.
- End cover can be retro fitted to all Chatbox acoustic booths.
- Prices are for single sides only, for both sides two units are required.
- For Quattro versions 2 units are required per side.

Single Chatbox Accessories



CODE	DESCRIPTION	W	D	H	MTO
CBX1-WB	Whiteboard	700	25	750	£200
CBX1-TV	TV bracket	175	50	175	£1000

- Add a whiteboard or a TV bracket for a private conference call

Single Seat



CODE	W	D	H	Band A	Band B	Band C	Band D	Band E
CBX-LBS1	870	610	978	£1000	£1100	£1200	£1300	£1400

- Compact Design
- Design specifically for Chatbox range of hubs
- Solo will require one unit
- Duo will require two units
- Quattro will require four units

Tables



CODE	W	D	H	MTO
CBX-TAB1	600	600	725	£400
CBX-TAB2	1400	600	725	£280

- Integrated fixing in the floor
- Increased leg space
- 25mm tops
- Black Steel leg frames

To fit Solo



DESCRIPTION
1 seat

To fit Duo



DESCRIPTION
2 seats
1 table

To fit Quattro



DESCRIPTION
4 seats
2 table

MTO



Black
(K)



White
(WH)



Kendal Oak
(KO)

DESK

RANGES

HEIGHT ADJUSTABLE



ELEV8² TOUCH
22



ELEV8² MONO
28

BENCH



ADAPT
32



FUZE
40



CONNEX II
46



MAESTRO 25
52

CABLE MANAGED



TR10
56



VIVO
60



MAESTRO 25
CABLE MANAGED
64

CONTRACT



MAESTRO 25
CANTILEVER
70



MAESTRO 25
PANEL END
76



MAESTRO 25
H FRAME
82



CONTRACT 25
86

EXECUTIVE



ANSON
94

ELEV8² TOUCH

SIT-STAND DESKING

The ability to sit and stand during the average working day has huge health benefits to the user, helping to burn calories, boost energy levels, improve posture and promote mental well-being.

In addition to the numerous health benefits provided by periodic standing, studies show that Elev8² height adjustable desks promote creativity, team interaction, collaboration, and the willingness to share ideas.



Product warranty



Designed & manufactured

BS EN527-2:2016+A1:2019
EN1729-2:2012+A1:2015



Desk frame colours



Black



Silver



White

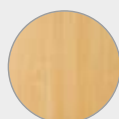

Beech

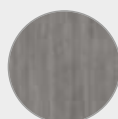

Grey Oak

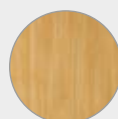

Oak

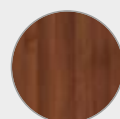

Walnut



White



White/Oak

Wood finishes



Elev8² Touch | Height Adjustable

Single Height Adjustable Desks



CODE	W	D	H	RRP
EVT-1200	1200	800	650-1250	£1326
EVT-1400	1400	800	650-1250	£1352
EVT-1600	1600	800	650-1250	£1381



- Single straight desks 800mm deep with adjustability from 650mm-1250mm
- Powerful twin motors raise and lower the desktop at a 39db noise level

Return Height Adjustable Desk



CODE	W	D	H	RRP
EVT-RET	600	800	650-1250	£967



- Sits on either side of the sit-stand straight desks to increase the working area
- The two base columns of the straight and return desk stay perfectly synched

Single Height Adjustable Desks with Returns



CODE	W	D	H	w	d	RRP
EVTR-1400	1400	800	650-1250	600	1600	£2318
EVTR-1600	1600	800	650-1250	600	1600	£2346

- Rectangular desks 800mm deep complete with 800mm return desk
- Return can be fitted to either side of desk to extend the sit-stand working area

Vibe Screens for Single Desks



CODE	W	D	H	Band A	Band B	Band C	Band D	Band E
EV1000	1000	25	600	£235	£253	£284	£306	£331
EV1200	1200	25	600	£270	£284	£311	£336	£363
EV1400	1400	25	600	£298	£311	£343	£370	£399
EV1600	1600	25	600	£331	£343	£374	£403	£436

- Made to order designer office screens supplied with fitting brackets
- 25mm thick screens which are 600mm high specifically for Elev8² single desks



Please add frame finish followed by desktop finish when ordering eg. **EVT-1600** with Black frame in Oak = **EVT-1600-K-O**

Elev8² Touch | Height Adjustable

Back-to-Back Height Adjustable Desks



CODE	W	D	H	RRP
EVTB-1200	1200	1650	650-1250	£2758
EVTB-1400	1400	1650	650-1250	£2827
EVTB-1600	1600	1650	650-1250	£2895

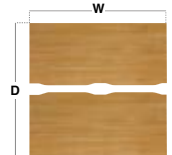

- Two straight 800mm deep desks back-to-back, adjusts from 650mm-1250mm
- Powerful twin motors raise and lower the back-to-back desks independently

Vibe Straight Screens for Back-to-Back Desks

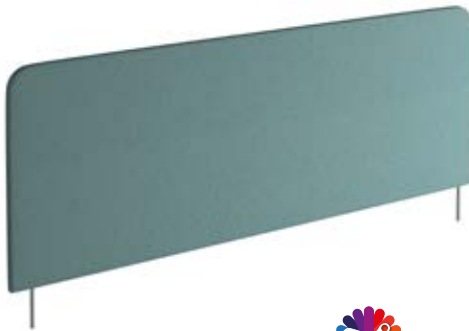

CODE	W	D	H	Band A	Band B	Band C	Band D	Band E
EVSS-1200	1200	25	600	£276	£290	£307	£336	£376
EVSS-1400	1400	25	600	£353	£367	£383	£429	£498
EVSS-1600	1600	25	600	£390	£421	£451	£505	£608

- Made to order designer office screens 600mm high
- 25mm thick screens specifically designed for Elev8² Touch back-to-back desks

Vibe Curved Screens for Back-to-Back Desks



CODE	W	D	H	Band A	Band B	Band C	Band D	Band E
EVSC-1200	1200	25	400-700	£290	£307	£321	£348	£386
EVSC-1400	1400	25	400-700	£363	£379	£391	£435	£504
EVSC-1600	1600	25	400-700	£400	£428	£456	£508	£605

- Made to order designer office screens 700mm high at central point
- 25mm thick screens specifically designed for Elev8² Touch back-to-back desks



Please add frame finish followed by desktop finish when ordering eg. **EVTB-1600** with Black frame in Oak = **EVTB-1600-K-O**

Create a healthier work environment

Many employers are now providing workers with height adjustable desks, allowing workers to alternate between sitting and standing throughout the day. Sit-stand desks have a height adjustable feature so that you can stand or sit comfortably and work proficiently. They come in all shapes and sizes, just like people, and are suitable for any employee and work environment – in the office or at home – with a design based on exhaustive ergonomic research to provide an optimal workstation.

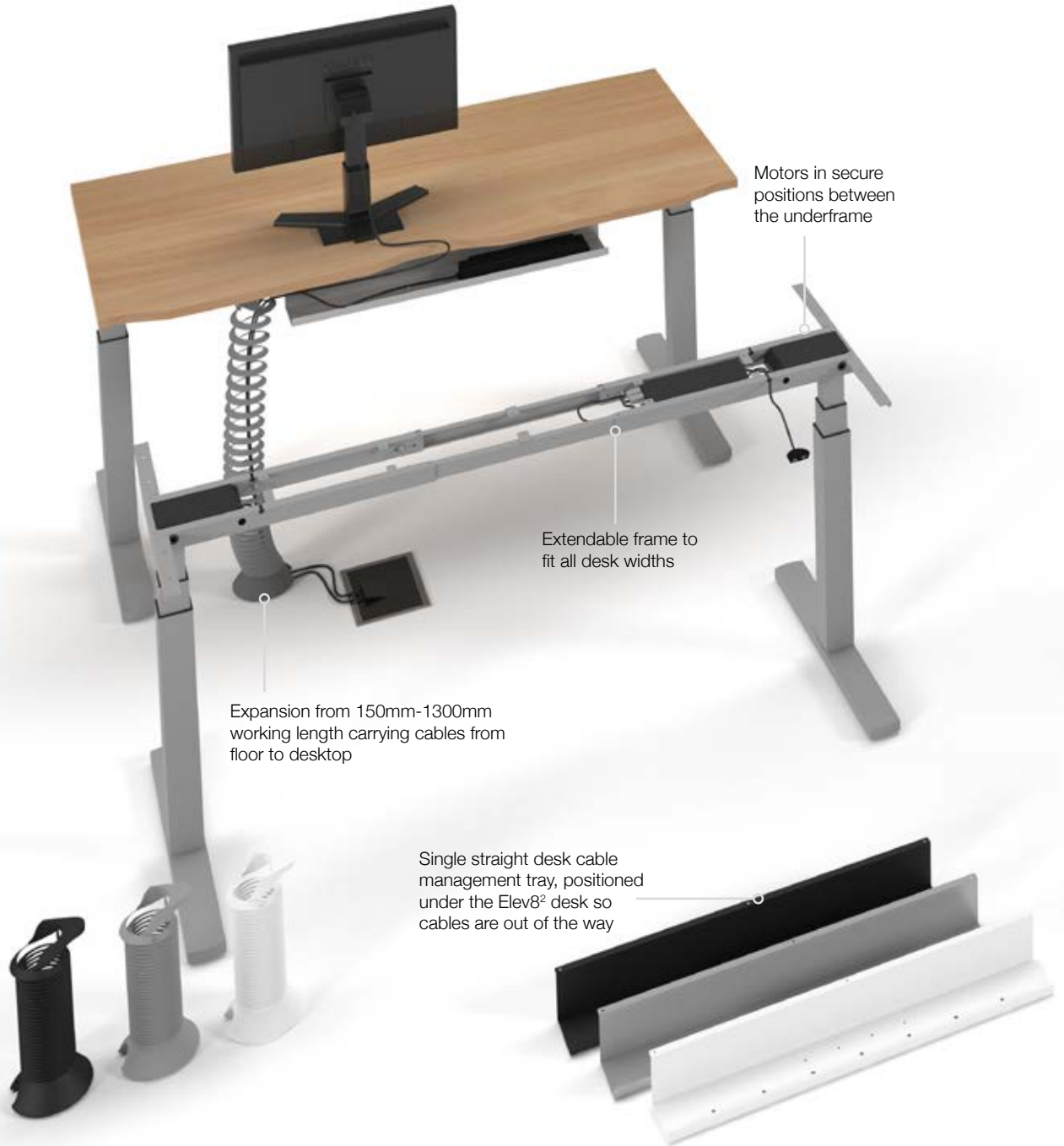

Vertical cable spiral

CODE	W	D	H	RRP
EV-SN	80	80	150-1300	£100

Upper cable channel

CODE	W	D	H	RRP
EV-UCC	800	100	100	£42

Elev8² Touch | Accessories

Allows for 4 different stored height settings and can be fitted to all Elev8² Touch desking



Digital control box

CODE	W	D	H	RRP
TDH5-P	105	40	20	£110

Easy detachable battery pack, charged with a standard USB



Battery pack

CODE	RRP
EVT-BPK	£476

Insert the dongle into the control box of the existing desk and download the app for height adjustment and preferences



Stand Up PIs
TIMOTION

Bluetooth control

CODE	RRP
EVT-BCU	£92



Vertical cable chain

Fits inside the lower cable channel of back-to-back desks for cable management

Shared cable tray with cover which sits central to two back-to-back Elev8² desks Available in black, silver & white to match leg frames

Vertical cable chain

CODE	W	D	H	RRP
EV-CHAIN-K	52	25	1000	£108

Lower cable channel

CODE	W	D	H	RRP
EV-LCC-854	1028	250	100	£142
EV-LCC-1054	1228	250	100	£182
EV-LCC-1254	1428	250	100	£225

Please add finish when ordering eg. **EV-LCC-1254** in Silver = **EV-LCC-1254-S**

ELEV8² MONO

SIT-STAND DESKING

Elev8² Mono sit-stand desks allow the individual user to electronically adjust the desk height from a sitting to a standing position with the touch of a button.

Having the option to stand, as well as sit during the work day has been proven not only to benefit the health of the user but also of the business, dramatically improving health, well-being and energy levels of employees.



BS EN527-1:2011
EN1729-2:2012+A1:2015



Desk frame colours

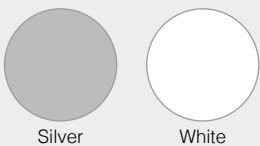

Wood finishes

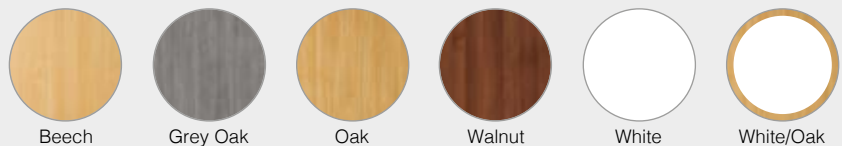



Elev8² Mono | Height Adjustable

Single Height Adjustable Desks



CODE	W	D	H	RRP
EVM-1200	1200	800	700-1200	£735
EVM-1400	1400	800	700-1200	£754
EVM-1600	1600	800	700-1200	£774



- Single straight desks 800mm deep with adjustability from 700mm-1200mm
- The single motor adjusts the desktop height at a 44db noise level

Vibe Screen for Single Desks



CODE	W	D	H	Band A	Band B	Band C	Band D	Band E
EV1000	1000	25	600	£235	£253	£284	£306	£331
EV1200	1200	25	600	£270	£284	£311	£336	£363
EV1400	1400	25	600	£298	£311	£343	£370	£399
EV1600	1600	25	600	£331	£343	£374	£403	£436

- Made to order designer office screens supplied with fitting brackets
- 25mm thick screens which are 600mm high specifically for Elev8² single desks



Upper Cable Channel

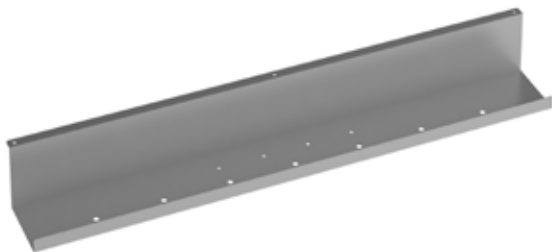

CODE	W	D	H	RRP
EV-UCC	800	100	100	£42

- Cable management tray positioned under desk to use on single straight desks
- Available in silver or white to match leg frames

Vertical Cable Spiral



CODE	W	D	H	RRP
EV-SN	80	80	150-1300	£100

- Spring like expansion which expands to carry cables from 150mm-1300mm
- Available in silver or white to match leg frames

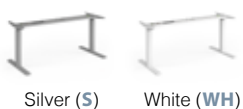

Please add frame finish followed by desktop finish when ordering eg. **EVM-1600** with Silver frame in Walnut = **EVM-1600-S-W**

Why opt for a sit-stand solution?

Are you sitting comfortably? You might not be by the time you finish reading this, because spending too much time perched on your posterior could be seriously damaging your health. Put simply, a healthier workforce is a happier, more motivated and more productive workforce.

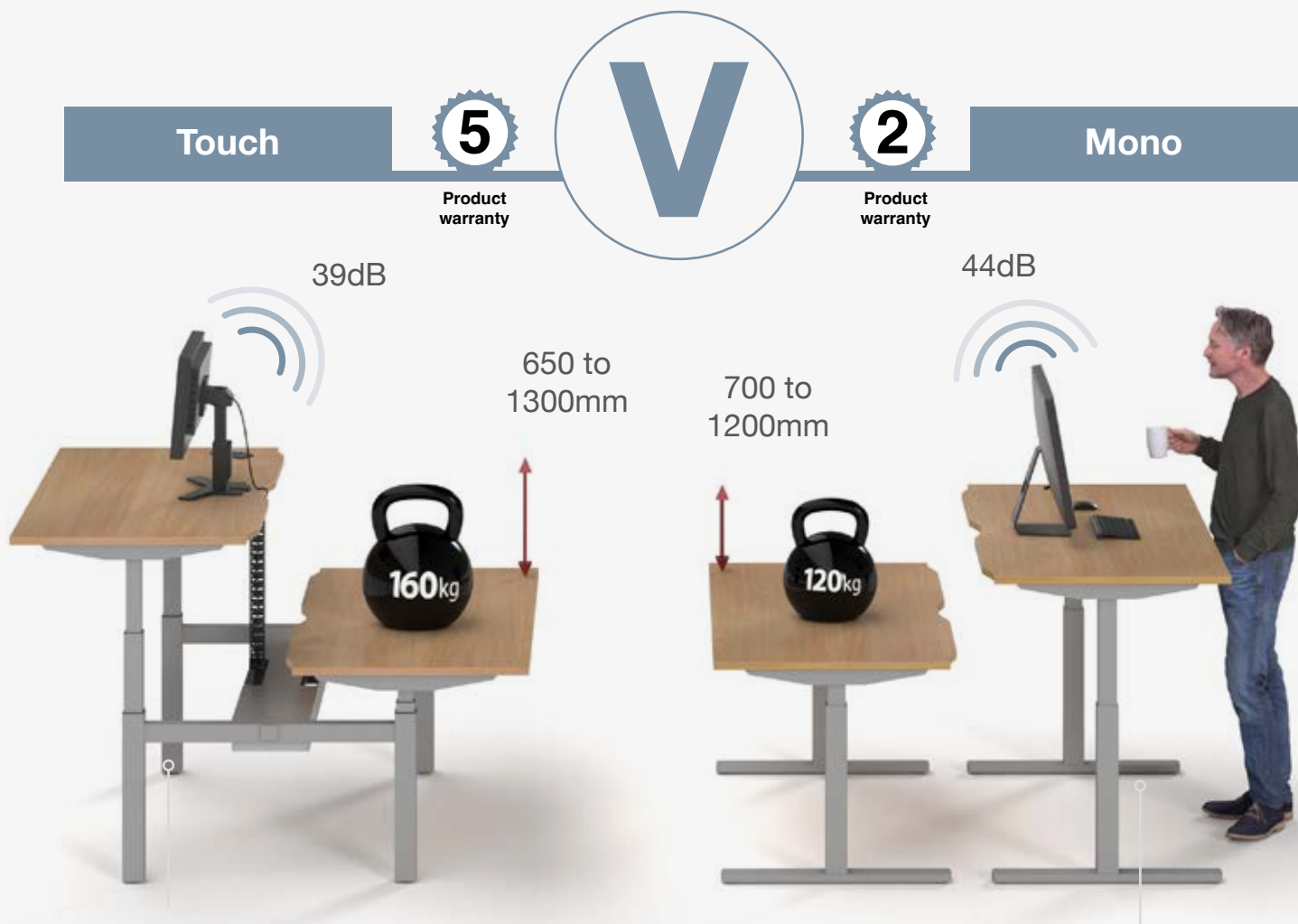

3 part leg Black, Silver or White			2 part leg Silver or White
Single and back-to-back desks			Single desks
Twin motors per desk			Single motor per desk
Control unit			Control unit

Studies also show that Elev8 sit-stand desks promote creativity, team interaction, collaboration, and the willingness to share ideas. So, when it comes to the Elev8 range, a desk is much more than a place to work - it's a working culture that benefits both the employee and the company.

ADAPT

BENCH DESK SYSTEM

Adapt is our vision for systems furniture in the contemporary office. Offering a flexible approach to office furniture design, it is perfect for matching desking with meeting tables and even executive desk design for the totally integrated look.

Sleek and stylish with clean cut lines and balanced proportions, the Adapt benching solution is a real stand out in the modern office environment.



Product warranty



Designed & manufactured

EN527-1:2001
EN527-2:2016+A1:2019
EN17292:2012+A1:2-15

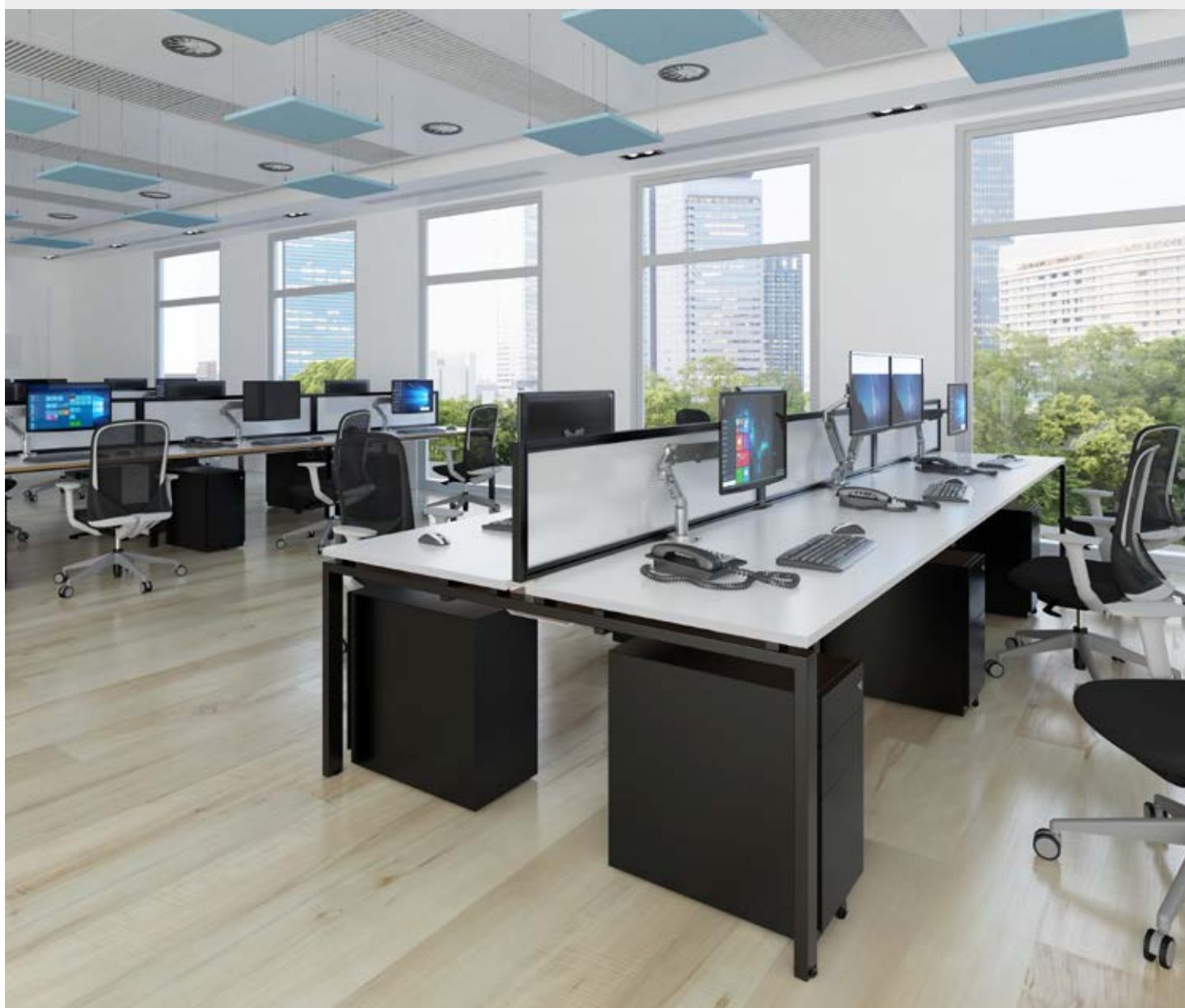

Desk frame colours



Black



Silver



White

Wood finishes

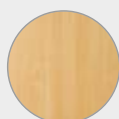

Beech

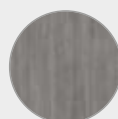

Grey Oak

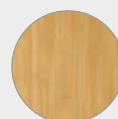

Oak

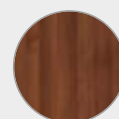

Walnut



White



White/Oak

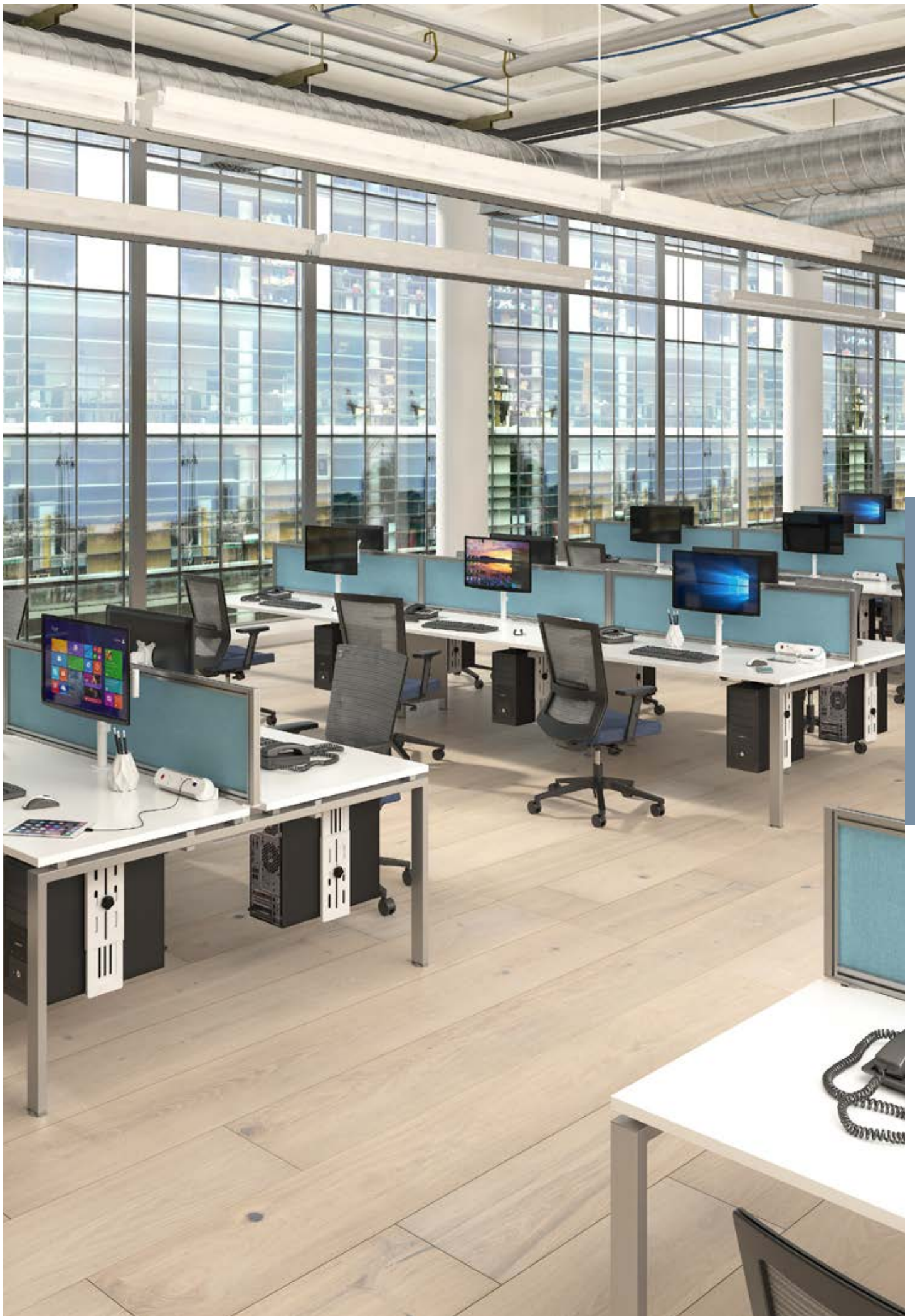

Adapt | Bench Desking

Single Desks 600mm



CODE	W	D	H	RRP
E126	1200	600	725	£460
E146	1400	600	725	£479
E166	1600	600	725	£508



- Single straight desks 600mm deep with scalloped cut outs in the desktops
- Sturdy steel framework and bench tops which take on a floating appearance

600mm Add-on Units



CODE	W	D	H	RRP
E126-AB	1200	600	725	£306
E146-AB	1400	600	725	£325
E166-AB	1600	600	725	£357

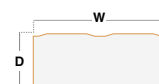

- Single straight add-on unit desk with scalloped cut outs in the desktops
- Use with single desks to extend into a modular system

Single Desks 800mm



CODE	W	D	H	RRP
E128	1200	800	725	£510
E148	1400	800	725	£537
E168	1600	800	725	£574



- Single straight desks 800mm deep with scalloped cut outs in the desktops
- Sturdy steel framework and bench tops which take on a floating appearance

800mm Add-on Units



CODE	W	D	H	RRP
E128-AB	1200	800	725	£341
E148-AB	1400	800	725	£366
E168-AB	1600	800	725	£400

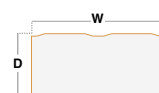

- Single straight add-on unit desk with scalloped cut outs in the desktops
- Use with single desks to extend into a modular system

Single Desks with Returns



CODE	W	D	H	w	d	RRP
ER1488	1400	800	725	600	1600	£745
ER1688	1600	800	725	600	1600	£772

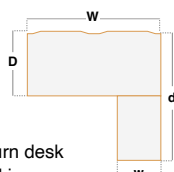

- Rectangular desks 800mm deep complete with 800mm return desk
- Return can be fitted to either side of desk to extend the working area

Single Desk Cable Trays



CODE	Usage	W	D	H	RRP
ED12SCT	Fits 1200 wide desk	1000	100	60	£85
ED14SCT	Fits 1400 wide desk	1200	100	60	£97
ED16SCT	Fits 1600 wide desk	1400	100	60	£142

- Cable management tray positioned under desk to use on single straight desks
- Available in black, silver or white to match leg frames



Please add frame finish followed by desktop finish when ordering eg. **E166** with White frame in White/Oak = **E166-WH-WO**

Adapt | Bench Desking

Back-to-Back Desks



CODE	W	D	H	RRP
E1212	1200	1200	725	£841
E1412	1400	1200	725	£872
E1612	1600	1200	725	£937
E1216	1200	1600	725	£898
E1416	1400	1600	725	£946
E1616	1600	1600	725	£1018

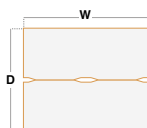

- Two straight desks back-to-back with scalloped cut outs in the desktops
- Extended sturdy steel framework and bench tops which take on a floating look

Back-to-Back Add-on Units



CODE	W	D	H	RRP
E1212-AB	1200	1200	725	£538
E1412-AB	1400	1200	725	£575
E1612-AB	1600	1200	725	£634
E1216-AB	1200	1600	725	£593
E1416-AB	1400	1600	725	£643
E1616-AB	1600	1600	725	£709

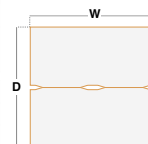

- Two straight add-on unit desks back-to-back with scalloped cut outs
- Use with back-to-back desks to extend into a modular system

Double Back-to-Back Desks



CODE	W	D	H	RRP
E2412	2400	1200	725	£1375
E2812	2800	1200	725	£1442
E3212	3200	1200	725	£1563
E2416	2400	1600	725	£1484
E2816	2800	1600	725	£1585
E3216	3200	1600	725	£1724

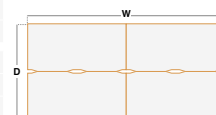

- Four straight desks in a double back-to-back bench desk configuration
- Legs are shared between desk clusters with a recessed centre leg support

Triple Back-to-Back Desks

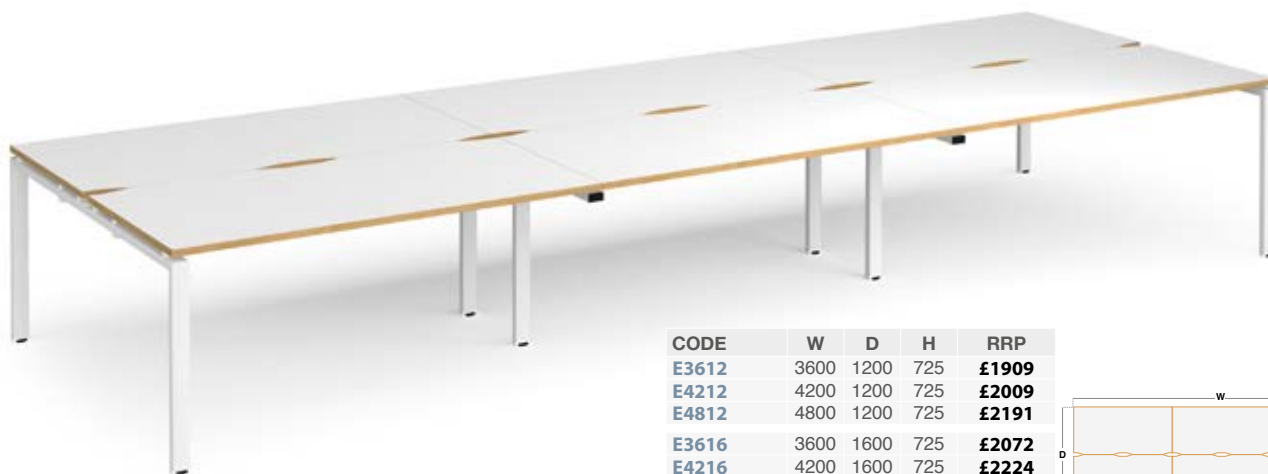

CODE	W	D	H	RRP
E3612	3600	1200	725	£1909
E4212	4200	1200	725	£2009
E4812	4800	1200	725	£2191
E3616	3600	1600	725	£2072
E4216	4200	1600	725	£2224
E4816	4800	1600	725	£2430

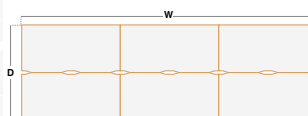

- Six straight desks in a triple back-to-back bench desk configuration
- Legs are shared between desk clusters with two recessed centre leg supports



Please add frame finish followed by desktop finish when ordering eg. **E1616** with White frame in White/Oak = **E1616-WH-WO**

Adapt | Bench Desking

Back-to-Back Desks with Returns



CODE	W	D	H	w	d	RRP
ER14168	1400	1600	725	600	3200	£1352
ER16168	1600	1600	725	600	3200	£1422

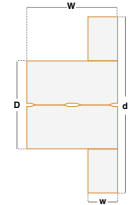

- Two straight desks back-to-back with scalloped cutouts and return desks
- Extended sturdy steel framework and bench tops which take on a floating look

Double Straight Desks with Returns



CODE	W	D	H	w	d	RRP
ER2888	2800	800	725	600	1600	£1352
ER3288	3200	800	725	600	1600	£1422

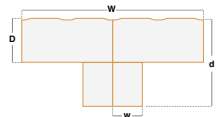

- Two straight desks side-by-side with scalloped cutouts and return desks
- Returns can be fitted to either side of desk to extend the working area

Four Desk Clusters with Returns



CODE	W	D	H	w	d	RRP
ER28168	2800	800	725	600	3200	£2297
ER32168	3200	800	725	600	3200	£2432

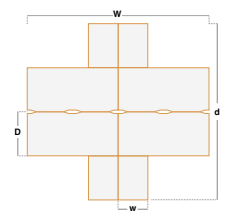

- Back-to-back desks with returns for a modern bench desk configuration
- Legs are shared between desk clusters with a recessed centre leg support



Please add frame finish followed by desktop finish when ordering eg. **ER16168** with White frame in White/Oak = **ER16168-WH-WO**

Adapt | Sliding Top Bench Desking

Back-to-Back Desks - Sliding Tops



CODE	W	D	H	RRP
STE1212	1200	1200	725	£1074
STE1412	1400	1200	725	£1118
STE1612	1600	1200	725	£1196
STE1216	1200	1600	725	£1147
STE1416	1400	1600	725	£1215
STE1616	1600	1600	725	£1301

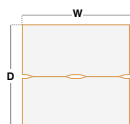

- Two straight desks back-to-back with scalloped cut outs in the tops
- Desktops slide forward up to 125mm allowing greater cable access

Back-to-Back Add-On Units - Sliding Tops



CODE	W	D	H	RRP
STE1212-AB	1200	1200	725	£668
STE1412-AB	1400	1200	725	£731
STE1612-AB	1600	1200	725	£810
STE1216-AB	1200	1600	725	£757
STE1416-AB	1400	1600	725	£822
STE1616-AB	1600	1600	725	£910

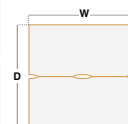

- Two straight add-on unit desks back-to-back with tops that slide forward
- Recessed leg is positioned in the centre of the bench desks

Double Back-to-Back Desks - Sliding Tops



CODE	W	D	H	RRP
STE2412	2400	1200	725	£1756
STE2812	2800	1200	725	£1844
STE3212	3200	1200	725	£1999
STE2416	2400	1600	725	£1899
STE2816	2800	1600	725	£2032
STE3216	3200	1600	725	£2167

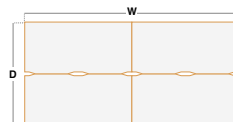

- Four straight desks in a double back-to-back bench desk configuration
- Desktops slide forward up to 125mm allowing greater cable access

Triple Back-to-Back Desks - Sliding Tops

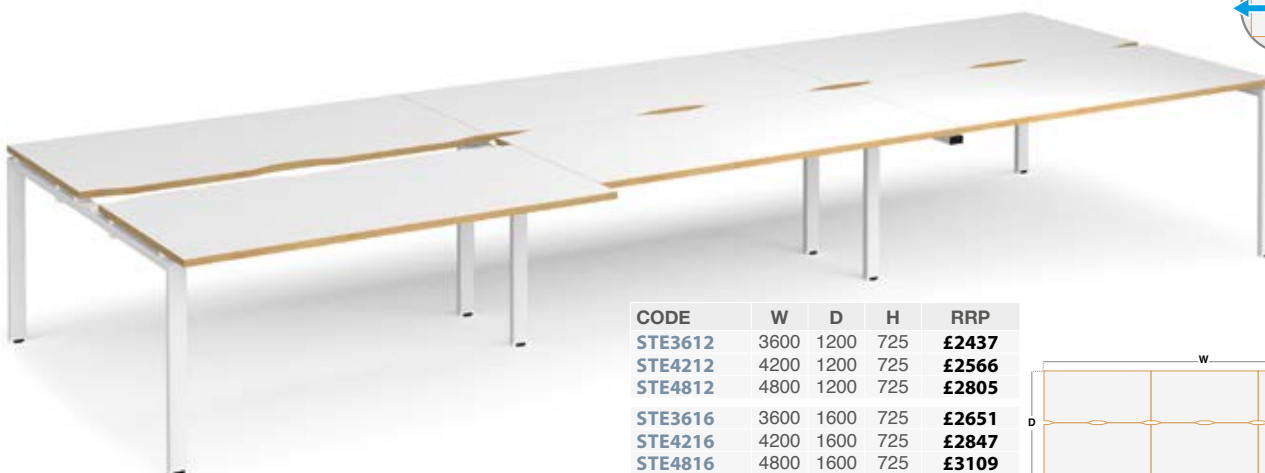

CODE	W	D	H	RRP
STE3612	3600	1200	725	£2437
STE4212	4200	1200	725	£2566
STE4812	4800	1200	725	£2805
STE3616	3600	1600	725	£2651
STE4216	4200	1600	725	£2847
STE4816	4800	1600	725	£3109

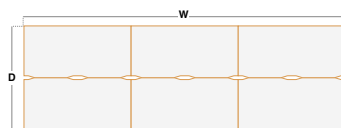

- Six straight desks in a triple back-to-back bench desk configuration
- Horizontal and vertical cable management solutions available



Please add frame finish followed by desktop finish when ordering eg. STE1616 with White frame in White/Oak = STE1616-WH-WO

Start simple then Adapt easily!



Step 1

Select a starter unit which can be single desk or back-to-back desks. Choose your add-on unit in the same width, depth and finish as the starter unit

Please note:

Don't mix 600mm deep desks with 800mm deep desks, and don't mix 1200mm deep with 1600mm deep back-to-back desk clusters. You can't mix fixed tops and sliding top desks.



Step 2

Remove one set of legs from the starter unit and add to the end of the add-on unit



Step 3

Connect the add-on unit to the starter unit. Simply repeat the process and connect more add-on units to create runs of desks



Beam

Steel legs and framework for enhanced strength and stability

Manages all the cables from the desk to the floor, with a front panel that can be removed quickly and easily to gain access to wires

Mass cable riser

CODE	W	D	H	RRP
EDCR	390	65	500	£172

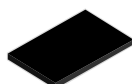

Black (K)



Silver (S)



White (WH)

Please add metal finish when ordering eg. **EDCR** in White = **EDCR-WH**

Offering choice is essential when creating a space for an agile workforce, and Adapt's thoughtful design and versatile components help you to do more with less.

The flexibility of bench desking allows for easy reconfiguration and expansion of the work area as one project is completed and a new team moves into the space.

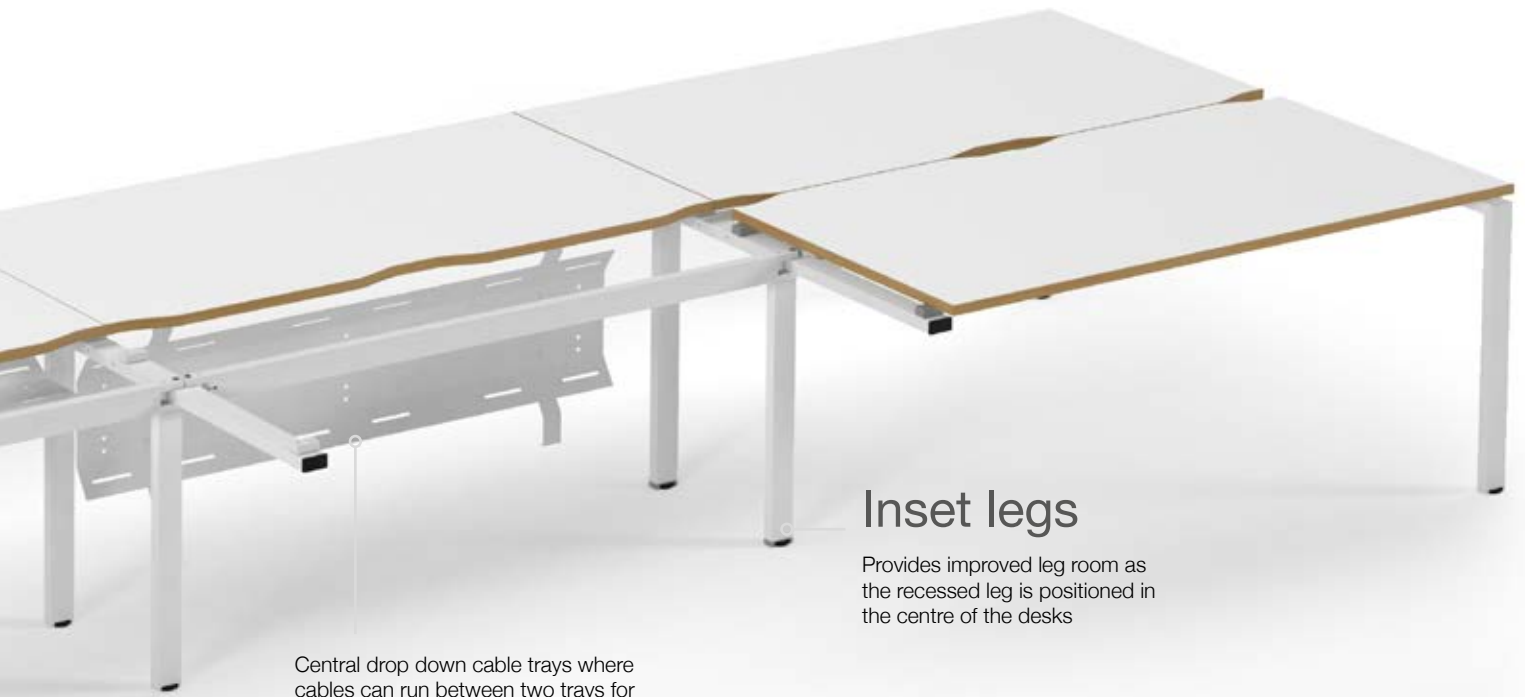

Inset legs

Provides improved leg room as the recessed leg is positioned in the centre of the desks

Central drop down cable trays where cables can run between two trays for effective cable management

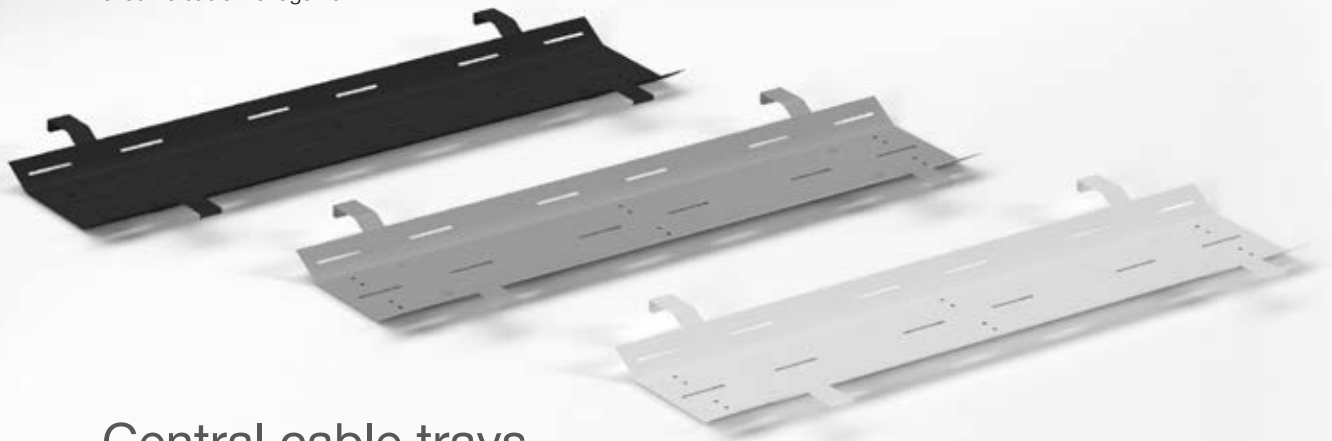

Central cable trays

CODE	USAGE	W	D	H	RRP
ED12DCT	Fits 1200 wide desk	1000	320	60	£152
ED14DCT	Fits 1400 wide desk	1200	320	60	£160
ED16DCT	Fits 1600 wide desk	1400	320	60	£167

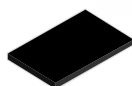

Black (K)



Silver (S)



White (WH)

Please add metal finish when ordering eg. **ED16DCT** in White = **ED16DCT-WH**

FUZE

STYLISH BENCH DESKING

Increasingly, businesses are moving away from dedicated single employee workspaces, towards more flexible working environments, and bench desk systems are the ideal solution for high density open plan workplaces.

Fuze bench desks blend the best of European design with the highest workmanship standards to span a wide range of applications and support the most creative of workspaces.



EN527-1:2001
EN527-2:2016+A1:2019
EN17292:2012+A1:2-15



Desk frame colours

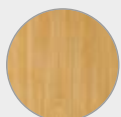

Oak legs & White metal frame

Wood finishes

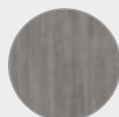

Grey Oak

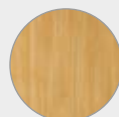

Oak



White



White/Oak



Fuze | Bench Desking

Single Desks



CODE	W	D	H	RRP
FZ128	1200	800	725	£891
FZ148	1400	800	725	£930
FZ168	1600	800	725	£965

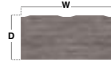

- Single straight desks 800mm deep with scalloped cutouts in the desktops
- Ideal for the home or the workplace

Single Desk Cable Tray



CODE	Usage	W	D	H	RRP
ED12SCT	Fits 1200 wide desk	1000	100	60	£85
ED14SCT	Fits 1400 wide desk	1200	100	60	£97
ED16SCT	Fits 1600 wide desk	1400	100	60	£142

- Cable management tray to use on single straight desks
- Positioned under the desk so cables are out of the way but easily accessible



White (WH)



Grey Oak (GO)



Oak (O)



White (WH)



White/Oak (WO)

Fuze | Bench Desking

Back-to-Back Desks



CODE	W	D	H	RRP
FZ1216	1200	1600	725	£1079
FZ1416	1400	1600	725	£1151
FZ1616	1600	1600	725	£1188

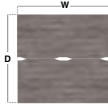

- Two straight 800mm deep desks with scalloped cutouts in the desktops
- Solid oak legs provide a stylish twist on bench desking with a steel frame

Back-to-Back Add-on Units



CODE	W	D	H	RRP
FZ1216-AB	1200	1600	725	£634
FZ1416-AB	1400	1600	725	£706
FZ1616-AB	1600	1600	725	£745

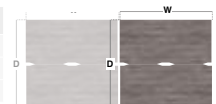

- Two straight 800mm deep desk add-on units back-to-back with scalloped cutouts
- Recessed solid oak leg is positioned in the centre of the desks

Double Back-to-Back Desks



CODE	W	D	H	RRP
FZ2416	2400	1600	725	£1707
FZ2816	2800	1600	725	£1854
FZ3216	3200	1600	725	£1929

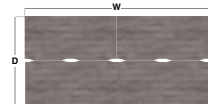

- Four straight 800mm deep desks in a double back-to-back bench desk configuration
- Solid oak legs are shared between desk clusters with a recessed centre leg support

Triple Back-to-Back Desks



CODE	W	D	H	RRP
FZ3616	3600	1600	725	£2335
FZ4216	4200	1600	725	£2556
FZ4816	4800	1600	725	£2665

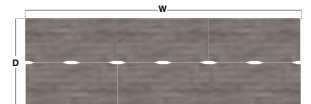

- Six straight 800mm deep desks in a triple back-to-back bench desk configuration
- Solid oak legs are shared between desk clusters with recessed centre leg supports



White (WH)



Grey Oak (GO)



Oak (O)



White (WH)



White/Oak (WO)

Please add frame finish followed by desktop finish when ordering eg. **FZ1616** with White frame in Grey Oak = **FZ1616-WH-GO**

Start simple then Fuze together!



Step 1

Select a starter unit which can be single desk or back-to-back desks. Choose your add-on unit in the same width and finish as the starter unit



Step 2

Remove one set of legs from the starter unit and add to the end of the add-on unit



Step 3

Connect the add-on unit to the starter unit. Simply repeat the process, connecting more add-on units to create runs of desks



Cable riser

Manages all the cables from the desk to the floor, with a front panel that can be removed quickly and easily to gain access to wires

CODE	W	D	H	RRP
FZCR	188-570	80	520	£138

Offering choice is essential when creating a space for an agile workforce, and Fuze's stylish design and versatile components help you to do more with less.

The flexibility of bench desking allows for easy reconfiguration and expansion of the work area as one project is completed and a new team moves into the space.



Cable tray

Central drop down cable trays where cables can run between two trays for effective cable management



CODE	USAGE	W	D	H	RRP
ED12DCT	Fits 1200 wide desk	1000	320	60	£152
ED14DCT	Fits 1400 wide desk	1200	320	60	£160
ED16DCT	Fits 1600 wide desk	1400	320	60	£167

Single desk cable tray

Cable management tray positioned under the desk so cables are out of the way but easily accessible



CONNEX II

MODULAR BENCH DESKING

Connex II bench desking is based on one principle – simplicity. With its clean lines and elegant form, Connex II offers a choice of classic tried and tested configurations from a single desk to hundreds of workstations in a wide variety of sizes to fit any office space.

The legs can be shared between bench clusters, which not only look aesthetically pleasing, but save space and decrease costs. New scalloped tops ease the fitting of desk accessories.



BS EN527-2:2016



Desk frame colours



Black

Silver

White

Wood finishes

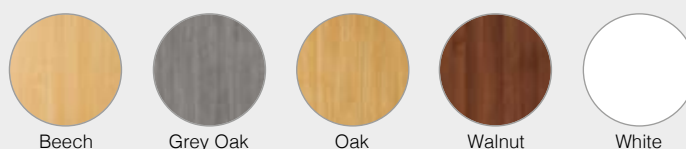

Beech

Grey Oak

Oak

Walnut

White



Connex II | Bench Desking

Single Desks



CODE	W	D	H	RRP
SCO128	1200	800	725	£349
SCO148	1400	800	725	£367
SCO168	1600	800	725	£392



- Single straight desks 800mm deep with scallop top
- Rectangular steel framework in silver or white with excellent strength & stability

Single Add-on Units



CODE	W	D	H	RRP
SCO128-AB	1200	800	725	£248
SCO148-AB	1400	800	725	£267
SCO168-AB	1600	800	725	£315



- Single desk add-on units 800mm deep, scallop top
- Recessed leg is positioned in the centre of the bench desks



Black (K)



Silver (S)



White (WH)



Beech (B)



Grey Oak (GO)



Oak (O)



Walnut (W)



White (WH)

Please add frame finish followed by desktop finish when ordering eg. **SCO1616** with Silver frame in Beech = **SCO1616-S-B**

Connex II | Bench Desking

Back-to-Back Desks



CODE	W	D	H	RRP
SCO1216	1200	1600	725	£610
SCO1416	1400	1600	725	£648
SCO1616	1600	1600	725	£692

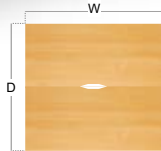

- Two straight 800mm deep desks back-to-back, scallop tops
- Extended rectangular steel framework for added strength & stability

Back-to-Back Add-on Units



CODE	W	D	H	RRP
SCO1216-AB	1200	1600	725	£402
SCO1416-AB	1400	1600	725	£449
SCO1616-AB	1600	1600	725	£485

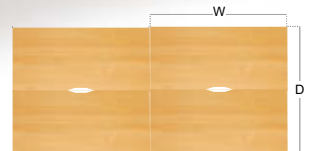

- Two straight 800mm deep add-on units back-to-back, supplied with a centre leg
- Recessed leg is positioned in the centre of the bench desks and can be extended

Double Back-to-Back Desks



CODE	W	D	H	RRP
SCO2416	2400	1600	725	£1010
SCO2816	2800	1600	725	£1092
SCO3216	3200	1600	725	£1172

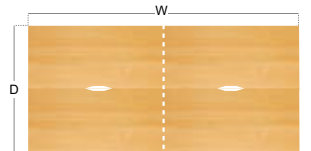

- Four straight 800mm deep desks in a double back-to-back bench desk configuration
- Legs are shared between desks, recessed centre leg support to save space and costs

Triple Back-to-Back Desks



CODE	W	D	H	RRP
SCO3616	3600	1600	725	£1448
SCO4216	4200	1600	725	£1515
SCO4816	4800	1600	725	£1654

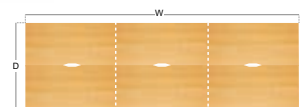

- Six straight 800mm deep desks in a triple back-to-back bench desk configuration
- Legs are shared between desk clusters with recessed centre leg supports



Black (K)



Silver (S)



White (WH)



Beech (B)



Grey Oak (GO)



Oak (O)



Walnut (W)



White (WH)

Please add frame finish followed by desktop finish when ordering eg. **SCO1616** with Silver frame in Beech = **SCO1616-S-B**

Start simple then Connex II add-on units!



Step 1

Select a starter unit which can be single desk or back-to-back desks. Choose your add-on unit in the same width and finish as the starter unit



Step 2

Remove one set of legs from the starter unit and add to the end of the add-on unit



Step 3

Connect the add-on unit to the starter unit. Simply repeat the process, connecting more add-on units to create runs of desks



Cross rail

Steel legs and framework for enhanced strength and stability

Mass cable riser

Manages all the cables from the desk to the floor

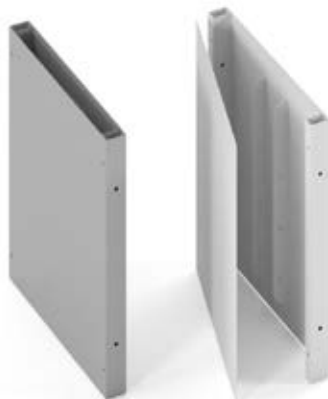

CODE	W	D	H	RRP
COUEDCR	450	50	700	£146

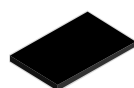

Black (K)



Silver (S)



White (WH)

Please add finish when ordering eg. COUEDCR in Silver = COUEDR-S

Offering choice is essential when creating a space for an agile workforce, and Connex's II clever design and versatile components help you to do more with less.

Cross rail construction combines a steel box section with a unique welded fixing bracket, Connex II is not only easy to assemble but is also robust enough to cope with the rigours of a busy office and is an ideal modular system for high density office spaces.



Cable basket

Central cable basket for wire management

Single cable basket

Single baskets to fit single desks



CODE	USAGE	W	D	H	RRP
WB0800-S	Fits 1000 wide desk	800	200	100	£91
WB1000-S	Fits 1200 wide desk	1000	200	100	£98
WB1200-S	Fits 1400 wide desk	1200	200	100	£109
WB1400-S	Fits 1600 wide desk	1400	200	100	£113

Double cable basket

Double baskets to fit back-to-back desks



CODE	USAGE	W	D	H	RRP
DWB0800	Fits 1000 wide desk	800	200	100	£99
DWB1000	Fits 1200 wide desk	1000	200	100	£114
DWB1200	Fits 1400 wide desk	1200	200	100	£125
DWB1400	Fits 1600 wide desk	1400	200	100	£140

MAESTRO 25

BENCH DESKING

The Maestro 25 Bench strikes a balance between individual and group activities in the workplace with fully welded H-Frame legs in black, silver and white that are shared between desks with a modesty panel to complement the 25mm melamine desktops.

A wide range of storage options are available including mobile pedestals and a selection of bookcases and cupboards, offering sensible storage solutions where efficiency and productivity are paramount.



EN527-1:2011
EN527-2:2016
EN1729-2:2012+A1:2015



Desk frame colours



Black

Silver

White

Wood finishes

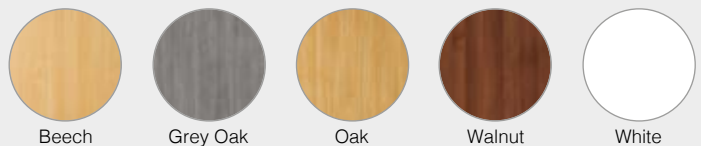

Beech

Grey Oak

Oak

Walnut

White



Maestro 25 | Bench Desking

Straight Desk 600mm



CODE	W	D	H	RRP
MB608	800	600	725	£265
MB610	1000	600	725	£280
MB612	1200	600	725	£293
MB614	1400	600	725	£307
MB616	1600	600	725	£322

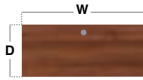

- Single straight desks 600mm deep with single cable access ports
- Fully welded H-Frame leg design ensures a strong and stable workstation

Straight Desks 800mm



CODE	W	D	H	RRP
MB8	800	800	725	£293
MB10	1000	800	725	£307
MB12	1200	800	725	£322
MB14	1400	800	725	£348
MB16	1600	800	725	£362
MB18	1800	800	725	£417

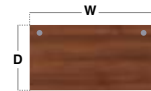

- Single straight desks 800mm deep with two cable ports
- MB8 & MB10 only have one cable access port

Left Hand Wave Desks



CODE	W	D	H	d	RRP
MB14WL	1400	800	725	990	£404
MB16WL	1600	800	725	990	£438

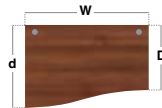

- Modern left hand wave desktops for a larger working area with H-frame leg
- Use individually or side-by-side with the right hand desk for a full wave effect

Right hand Wave Desks



CODE	W	D	H	d	RRP
MB14WR	1400	800	725	990	£404
MB16WR	1600	800	725	990	£438

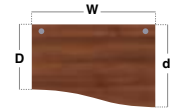

- Modern right hand wave desktops for a larger working area with H-frame leg
- Use individually or side-by-side with the left hand desk for a full wave effect

Left Hand Ergonomic Desks



CODE	W	D	H	w	d	RRP
MB14EL	1400	800	725	600	1200	£535
MB16EL	1600	800	725	600	1200	£574
MB18EL	1800	800	725	600	1200	£639

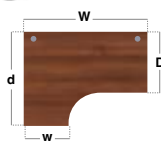

- Ergonomic left hand desktops with full H-Frame leg return
- Ideal to fit into corners or cluster together to maximise office space

Right Hand Ergonomic Desks



CODE	W	D	H	w	d	RRP
MB14ER	1400	800	725	600	1200	£535
MB16ER	1600	800	725	600	1200	£574
MB18ER	1800	800	725	600	1200	£639

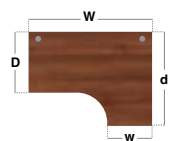

- Ergonomic right hand desktops with full H-Frame leg return
- Ideal to fit into corners or cluster together to maximise office space



Black (K)



Silver (S)



White (WH)



Beech (B)



Grey Oak (GO)



Oak (O)



Walnut (W)



White (WH)

Please add frame finish followed by desktop finish when ordering eg. **MB616** with White frame in Walnut = **MB616WHW**

Maestro 25 | Bench Desking

Back-to-Back Desks 1200mm



CODE	W	D	H	RRP
MB1012B	1000	1200	725	£508
MB1212B	1200	1200	725	£520
MB1412B	1400	1200	725	£535
MB1612B	1600	1200	725	£547

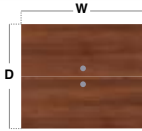

- Two straight 600mm desks back-to-back, both with single cable access ports
- Fully welded H-Frame leg design with shared leg and modesty panel

Back-to-Back Desks 1600mm



CODE	W	D	H	RRP
MB816B	800	1600	725	£547
MB1016B	1000	1600	725	£563
MB1216B	1200	1600	725	£574
MB1416B	1400	1600	725	£603
MB1616B	1600	1600	725	£616
MB1816B	1800	1600	725	£796

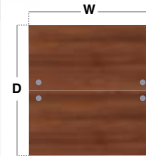

- Two straight 800mm desks back-to-back, two cable ports
- MB1616 & MB1016 only have one cable access port

Back-to-Back Wave Desks



CODE	W	D	H	d	RRP
MB14WB	1400	1600	725	1980	£760
MB16WB	1600	1600	725	1980	£831

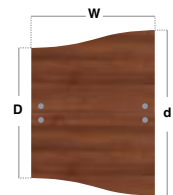

- Two wave desks in a back-to-back cluster
- H-Frame legs are shared between desks with a modesty panel

Back-to-Back Ergonomic Desks



CODE	W	D	H	w	d	RRP
MB14EB	1400	1600	725	600	2400	£1021
MB16EB	1600	1600	725	600	2400	£1107
MB18EB	1800	1600	725	600	2400	£1229

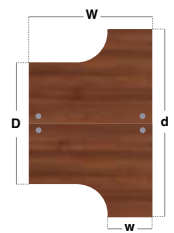

- Two ergonomic desks in a back-to-back cluster
- H-Frame legs are shared between desks with a modesty panel



Black (K)



Silver (S)



White (WH)



Beech (B)



Grey Oak (GO)



Oak (O)



Walnut (W)



White (WH)

Please add frame finish followed by desktop finish when ordering eg. **MB1612B** with White frame in Walnut = **MB1612BWHW**

TR10

MULTI-FUNCTIONAL DESKING

With its strong lines and elegant form, TR10 is a streamlined desking system built for demanding work places and is a popular choice for a wide range of projects.

The cable managed cantilever leg design allows users to hide and store unsightly cables, keeping them off the ground where they could create trip hazards and making the desk area both safe and aesthetically pleasing.



Product warranty



Designed & manufactured

BS EN527-2:2016+A1:2019
EN1729-2:2012+A1:2015



Desk frame colours



Silver

White

Wood finishes

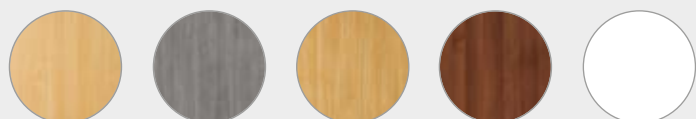

Beech

Grey Oak

Oak

Walnut

White

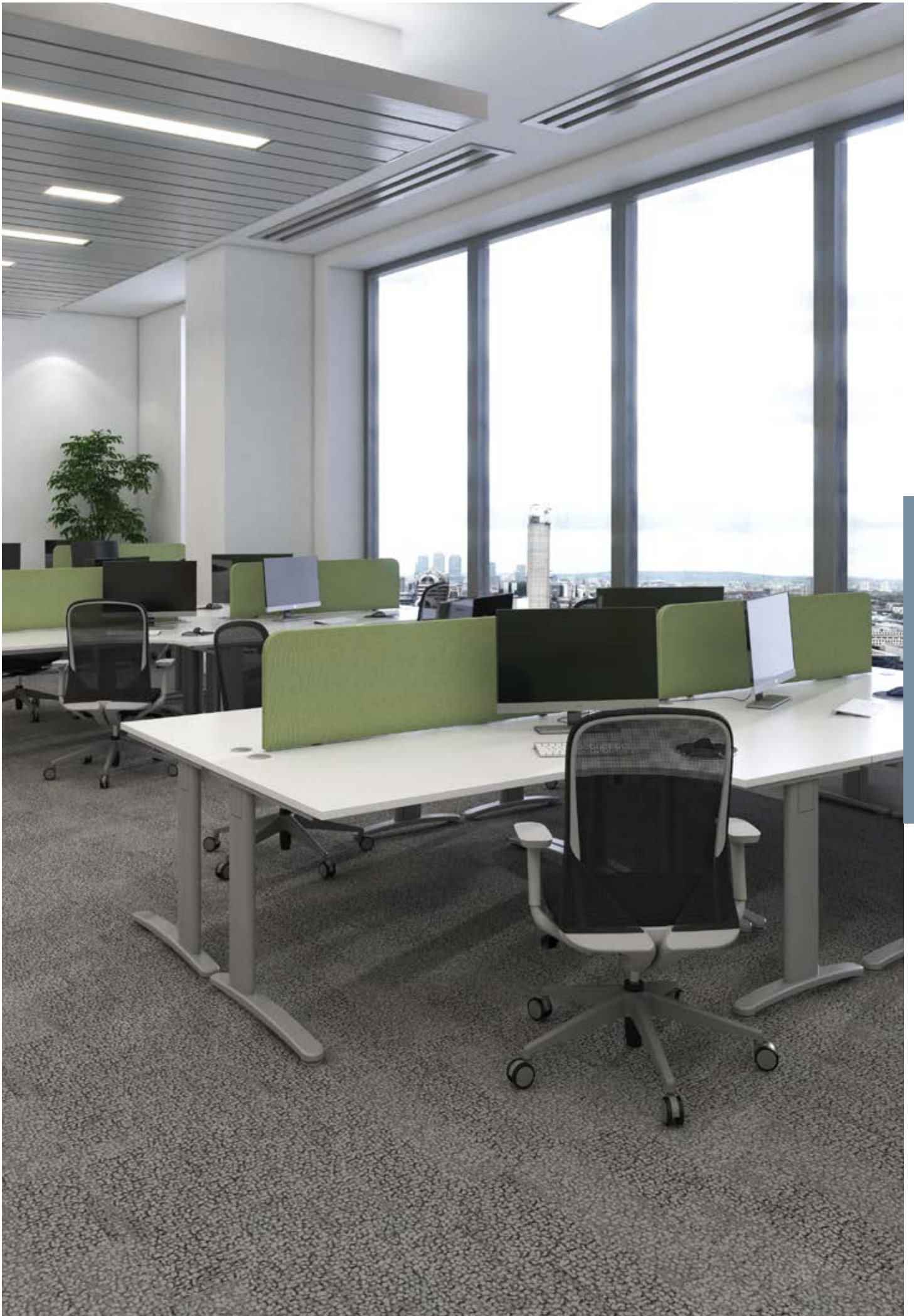

DESKS

TR10 | Cable Managed

Single Desks 600mm



CODE	W	D	H	RRP
T608	800	600	725	£412
T610	1000	600	725	£420
T612	1200	600	725	£439
T614	1400	600	725	£450
T616	1600	600	725	£471

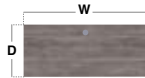

- Rectangular desks 600mm deep with single cable access ports
- Smaller desks are ideal for areas where space is limited

Single Desks 800mm



CODE	W	D	H	RRP
T8	800	800	725	£450
T10	1000	800	725	£460
T12	1200	800	725	£477
T14	1400	800	725	£487
T16	1600	800	725	£502
T18	1800	800	725	£572

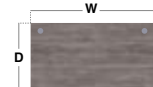

- Rectangular desks 800mm deep with two cable access ports
- T8 & T10 only have one central cable access port

Return Desk



CODE	W	D	H	RRP
TR86	800	600	725	£325



- 800mm return desk that sits on either side of the straight 800mm desks
- Comes complete with TR10 leg frame to retro-fit existing straight desks

Single Desks with Returns



CODE	W	D	H	w	d	RRP
TRD14	1400	800	725	600	1600	£745
TRD16	1600	800	725	600	1600	£765
TRD18	1800	800	725	600	1600	£825

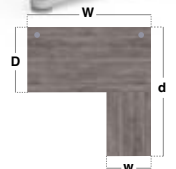

- Rectangular desks 800mm deep complete with 800mm return desk
- Return can be fitted to either side of desk to extend the working area

Height Settable Straight Desks



CODE	W	D	H	RRP
THS8	800	800	630-830	£730
THS10	1000	800	630-830	£741
THS12	1200	800	630-830	£761
THS14	1400	800	630-830	£766
THS16	1600	800	630-830	£788
THS18	1800	800	630-830	£831

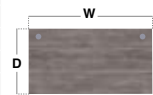

- Easily set the desk height at 630-830mm high or at 20mm intervals in between
- Ideal for people of various heights, and as extended height for wheelchair access



Silver (S)



White (W)



Beech (B)



Grey Oak (GO)



Oak (O)



Walnut (W)



White (WH)

Please add frame finish followed by desktop finish when ordering eg. **T616** with Silver frame in Grey Oak = **T616SGO**

TR10 | Cable Managed

Left Hand Wave Desks



CODE	W	D	H	d	RRP
TWL14	1400	800	725	990	£555
TWL16	1600	800	725	990	£593

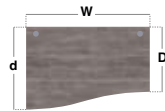

- Stylish, modern left hand wave desktops for a larger working area
- Use individually or side-by-side with the right hand desk for a full wave effect

Right Hand Wave Desks



CODE	W	D	H	d	RRP
TWR14	1400	800	725	990	£555
TWR16	1600	800	725	990	£593

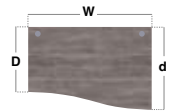

- Stylish, modern right hand wave desktops for a larger working area
- Use individually or side-by-side with the left hand desk for a full wave effect

Left Hand Ergonomic Desks



CODE	W	D	H	w	d	RRP
TBEL14	1400	800	725	600	1200	£625
TBEL16	1600	800	725	600	1200	£656
TBEL18	1800	800	725	600	1200	£688

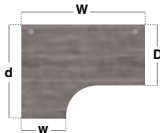

- Ergonomic left hand desktops with post leg return
- Ideal to fit into corners or cluster together to maximise office space

Right Hand Ergonomic Desks



CODE	W	D	H	w	d	RRP
TBER14	1400	800	725	600	1200	£625
TBER16	1600	800	725	600	1200	£656
TBER18	1800	800	725	600	1200	£688

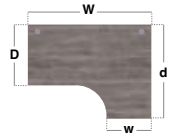

- Ergonomic right hand desktops with post leg return
- Ideal to fit into corners or cluster together to maximise office space

Left Hand Deluxe Ergonomic Desks



CODE	W	D	H	w	d	RRP
TDEL14	1400	800	725	600	1200	£819
TDEL16	1600	800	725	600	1200	£846
TDEL18	1800	800	725	600	1200	£883

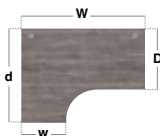

- Ergonomic left hand desktops with deluxe full leg return
- Ideal to fit into corners or cluster together to maximise office space

Right Hand Deluxe Ergonomic Desks



CODE	W	D	H	w	d	RRP
TDER14	1400	800	725	600	1200	£819
TDER16	1600	800	725	600	1200	£846
TDER18	1800	800	725	600	1200	£883

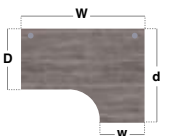

- Ergonomic right hand desktops with deluxe full leg return
- Ideal to fit into corners or cluster together to maximise office space



Silver (S)



White (W)



Beech (B)



Grey Oak (GO)



Oak (O)



Walnut (W)



White (WH)

Please add frame finish followed by desktop finish when ordering eg. **TWL16** with Silver frame in Grey Oak = **TWL16SGO**

VIVO

INTEGRATED CABLE MANAGEMENT

Vivo is an advanced desking system with contemporary styling and sleek, clean cut lines that lends itself to clear thinking and effective decision making.

Removable leg covers with integrated wire management in the leg riser combine with the dual access cable cut-outs in the top corners of the modesty panel for complete cable management.



Product warranty



Designed & manufactured



Desk frame colours



Silver

Wood finishes

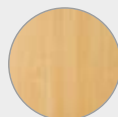

Beech

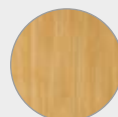

Oak

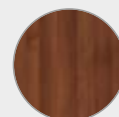

Walnut



White



Vivo | Desks

Single Desks 600mm



CODE	W	D	H	RRP
VEX8	800	600	725	£407
VEX10	1000	600	725	£412
VEX12	1200	600	725	£434
VEX14	1400	600	725	£451
VEX16	1600	600	725	£471

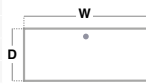

- Rectangular desks 600mm deep with modesty panel
- Smaller desks are ideal for areas where space is limited

Single Desks 800mm



CODE	W	D	H	RRP
V8	800	800	725	£459
V10	1000	800	725	£469
V12	1200	800	725	£482
V14	1400	800	725	£491
V16	1600	800	725	£521
V18	1800	800	725	£591



- Rectangular desks 800mm deep with modesty panel & two cable access ports
- V8 & V10 only have one central cable access port

Left Hand Wave Desks



CODE	W	D	H	d	RRP
VWL14	1400	800	725	990	£598
VWL16	1600	800	725	990	£621

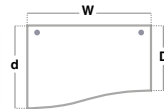

- Wave desktops for a larger working area with modesty panel & cable control
- Use individually or side-by-side with the right hand desk for a full wave effect

Right Hand Wave Desks



CODE	W	D	H	d	RRP
VWR14	1400	800	725	990	£598
VWR16	1600	800	725	990	£621

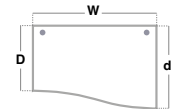

- Wave desktops for a larger working area with modesty panel & cable control
- Use individually or side-by-side with the left hand desk for a full wave effect

Left Hand Ergonomic Desks



CODE	W	D	H	w	d	RRP
VEL14	1400	800	725	600	1200	£676
VEL16	1600	800	725	600	1200	£721
VEL18	1800	800	725	600	1200	£795

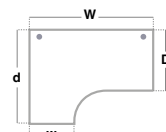

- Left hand desktops with modesty panels & full leg return with cable control
- Ideal to fit into corners or cluster together to maximise office space

Right Hand Ergonomic Desks



CODE	W	D	H	w	d	RRP
VER14	1400	800	725	600	1200	£676
VER16	1600	800	725	600	1200	£721
VER18	1800	800	725	600	1200	£795

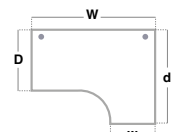

- Right hand desktops with modesty panels & full leg return with cable control
- Ideal to fit into corners or cluster together to maximise office space



Silver



Beech (B)



Oak (O)



Walnut (W)



White (WH)

Please add desktop finish when ordering eg. VEX16 in White = VEX16WH



100%
LIFETIME
WARRANTY

**REMOVEABLE LEG COVERS
FOR EFFECTIVE CABLE MANAGEMENT**

MAESTRO 25

CABLE MANAGED

This multi-functional desking collection is designed to fit a variety of office environments, whilst offering an effective and affordable solution to cable control, with 25mm desktops that ensure the strength and stability needed in commercial office furniture.

A wide range of storage options are available from fixed and mobile pedestals to a selection of bookcases and cupboards, offering sensible storage solutions where efficiency and productivity are paramount.



EN527-1:2011
EN527-2:2016
EN1729-2:2012+A1:2015



Desk frame colours



Black

Silver

White

Wood finishes

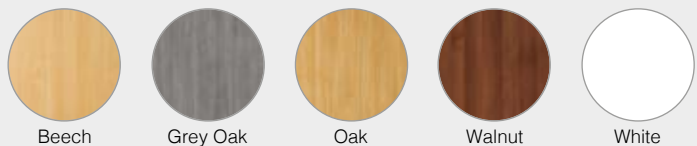

Beech

Grey Oak

Oak

Walnut

White



Straight Desks



CODE	W	D	H	RRP
MCM608	800	600	725	£395
MCM610	1000	600	725	£401
MCM612	1200	600	725	£420
MCM614	1400	600	725	£436
MCM616	1600	600	725	£458



- Rectangular desks 600mm deep with cantilever leg frame
- Single cable access port positioned centrally on desktop

Straight Desks with Two Drawer Pedestal



CODE	W	D	H	RRP
MCM612P2	1200	600	725	£558
MCM614P2	1400	600	725	£573
MCM616P2	1600	600	725	£594



- Rectangular desks 600mm deep with cable managed leg & single cable port
- Two drawer fixed pedestal which can be fitted to left or right hand side

Straight Desks with 2 x Two Drawer Pedestals



CODE	W	D	H	RRP
MCM616P22	1600	600	725	£732

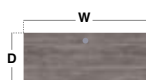

- Rectangular desks 600mm deep with cable managed leg & single cable port
- 2 x two drawer fixed pedestals with shallow drawers and handles



HOME OFFICE

OR

WORK PLACE



Black (K)



Silver (S)



White (WH)



Beech (B)



Grey Oak (GO)



Oak (O)



Walnut (W)



White (WH)

Please add frame finish followed by desktop finish when ordering eg. MCM616 with Silver frame in Grey Oak = MCM616SGO

Maestro 25 | Cable Managed

Straight Desks



CODE	W	D	H	RRP
MCM8	800	800	725	£443
MCM10	1000	800	725	£455
MCM12	1200	800	725	£464
MCM14	1400	800	725	£479
MCM16	1600	800	725	£507
MCM18	1800	800	725	£573



- Rectangular desks 800mm deep with cable managed leg & two cable ports
- MCM8 & MCM10 only have one central cable access port

Straight Desks with Two Drawer Pedestal



CODE	W	D	H	RRP
MCM12P2	1200	800	725	£603
MCM14P2	1400	800	725	£613
MCM16P2	1600	800	725	£643
MCM18P2	1800	800	725	£713

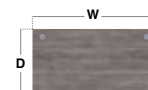

- Rectangular desks 800mm deep with cable managed leg & two cable ports
- Two drawer fixed pedestal which can be fitted to left or right hand side

Straight Desks with Three Drawer Pedestal



CODE	W	D	H	RRP
MCM12P3	1200	800	725	£603
MCM14P3	1400	800	725	£613
MCM16P3	1600	800	725	£643
MCM18P3	1800	800	725	£713

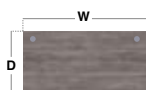

- Rectangular desks 800mm deep with cable managed leg & two cable ports
- Three drawer fixed pedestal which can be fitted to left or right hand side

Straight Desks with 2 x Two Drawer Pedestals



CODE	W	D	H	RRP
MCM16P22	1600	800	725	£781
MCM18P22	1800	800	725	£849

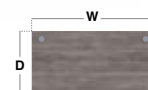

- Rectangular desks 800mm deep with cable managed leg & two cable ports
- 2 x two drawer fixed pedestals which accept A4 and foolscap files

Straight Desks with Two & Three Drawer Pedestals



CODE	W	D	H	RRP
MCM16P23	1600	800	725	£781
MCM18P23	1800	800	725	£849

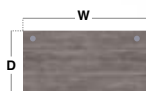

- Rectangular desks 800mm deep with cable managed leg & two cable ports
- Two and three drawer fixed pedestals which can be fitted to either side

Straight Desks with 2 x Three Drawer Pedestals



CODE	W	D	H	RRP
MCM16P33	1600	800	725	£781
MCM18P33	1800	800	725	£849

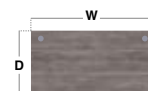

- Rectangular desks 800mm deep with cable managed leg & two cable ports
- 2 x three drawer fixed pedestals with three shallow drawers



Black (K)



Silver (S)



White (WH)



Beech (B)



Grey Oak (GO)



Oak (O)



Walnut (W)



White (WH)

Please add frame finish followed by desktop finish when ordering eg. MCM16 with Silver frame in Grey Oak = MCM16SGO

Maestro 25 | Cable Managed

Left Hand Wave Desks



CODE	W	D	H	d	RRP
MCM14WL	1400	800	725	990	£569
MCM16WL	1600	800	725	990	£590

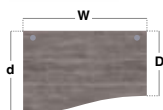

- Modern left hand wave desktops for a larger working area with cable managed leg
- Use individually or side-by-side with the right hand desk for a full wave effect

Right Hand Wave Desks



CODE	W	D	H	d	RRP
MCM14WR	1400	800	725	990	£569
MCM16WR	1600	800	725	990	£590

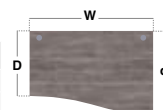

- Modern right hand wave desktops for a larger working area with cable managed leg
- Use individually or side-by-side with the left hand desk for a full wave effect

Left Hand Wave Desks with Two Drawer Pedestal



CODE	W	D	H	d	RRP
MCM14WLP2	1400	800	725	990	£758
MCM16WLP2	1600	800	725	990	£780

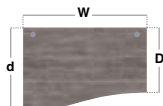

- Modern left hand wave desktops for a larger working area with cable managed leg
- Two drawer pedestal which is fixed to the 800mm deep end

Right Hand Wave Desks with Two Drawer Pedestal



CODE	W	D	H	d	RRP
MCM14WRP2	1400	800	725	990	£758
MCM16WRP2	1600	800	725	990	£780

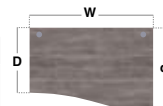

- Modern right hand wave desktops for a larger working area with cable managed leg
- Two drawer fixed pedestal which accepts A4 and foolscap files

Left Hand Wave Desks with Three Drawer Pedestal



CODE	W	D	H	d	RRP
MCM14WLP3	1400	800	725	990	£758
MCM16WLP3	1600	800	725	990	£780

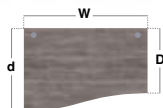

- Modern left hand wave desktops for a larger working area with cable managed leg
- Three drawer pedestal which is fixed to the 800mm deep end

Right Hand Wave Desks with Three Drawer Pedestal



CODE	W	D	H	d	RRP
MCM14WRP3	1400	800	725	990	£758
MCM16WRP3	1600	800	725	990	£780

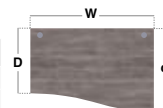

- Modern right hand wave desktops for a larger working area with cable managed leg
- Three drawer fixed pedestal with three shallow drawers



Black (K)



Silver (S)



White (WH)



Beech (B)



Grey Oak (GO)



Oak (O)



Walnut (W)



White (WH)

Please add frame finish followed by desktop finish when ordering eg. **MCM16WR** with Silver frame in Grey Oak = **MCM16WRSGO**

Maestro 25 | Cable Managed

Left Hand Ergonomic Desks



CODE	W	D	H	w	d	RRP
MCM14EL	1400	800	725	600	1200	£658
MCM16EL	1600	800	725	600	1200	£698
MCM18EL	1800	800	725	600	1200	£772

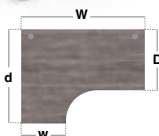

- Ergonomic left hand desktops with cable managed leg and full leg return
- Ideal to fit into corners or cluster together to maximise office space

Right Hand Ergonomic Desks



CODE	W	D	H	w	d	RRP
MCM14ER	1400	800	725	600	1200	£658
MCM16ER	1600	800	725	600	1200	£698
MCM18ER	1800	800	725	600	1200	£772

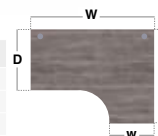

- Ergonomic right hand desktops with cable managed leg and full leg return
- Ideal to fit into corners or cluster together to maximise office space

Left Hand Ergonomic Desks with Two Drawer Pedestal



CODE	W	D	H	w	d	RRP
MCM16ELP2	1600	800	725	600	1200	£886
MCM18ELP2	1800	800	725	600	1200	£961

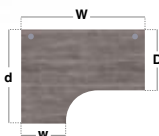

- Ergonomic left hand desktops with cable managed leg and full leg return
- Two drawer pedestal which is fixed to the 800mm deep end

Right Hand Ergonomic Desks with Two Drawer Pedestal



CODE	W	D	H	w	d	RRP
MCM16ERP2	1600	800	725	600	1200	£886
MCM18ERP2	1800	800	725	600	1200	£961

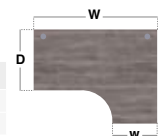

- Ergonomic right hand desktops with cable managed leg and full leg return
- Two drawer fixed pedestal which accepts A4 and foolscap files

Left Hand Ergonomic Desks with Three Drawer Pedestal



CODE	W	D	H	w	d	RRP
MCM16ELP3	1600	800	725	600	1200	£886
MCM18ELP3	1800	800	725	600	1200	£961

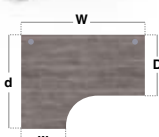

- Ergonomic left hand desktops with cable managed leg and full leg return
- Three drawer pedestal which is fixed to the 800mm deep end

Right Hand Ergonomic Desks with Three Drawer Pedestal



CODE	W	D	H	w	d	RRP
MCM16ERP3	1600	800	725	600	1200	£886
MCM18ERP3	1800	800	725	600	1200	£961

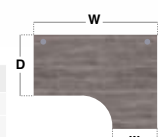

- Ergonomic right hand desktops with cable managed leg and full leg return
- Three drawer fixed pedestal with three shallow drawers



Black (K)



Silver (S)



White (WH)



Beech (B)



Grey Oak (GO)



Oak (O)



Walnut (W)



White (WH)

Please add frame finish followed by desktop finish when ordering eg. **MCM16ER** with Silver frame in Grey Oak = **MCM16ERSGO**

MAESTRO 25

CANTILEVER LEG

The welded double upright cantilever leg frame structure is powder coated for a stylish under frame and when combined with a 25mm melamine desktop ensures the strength and stability needed in commercial office furniture.

A wide range of storage options are available from fixed and mobile pedestals to a selection of bookcases and cupboards, offering sensible storage solutions where efficiency and productivity are paramount.



EN527-1:2011
EN527-2:2016
EN1729-2:2012+A1:2015



Desk frame colours



Black

Silver

White

Wood finishes

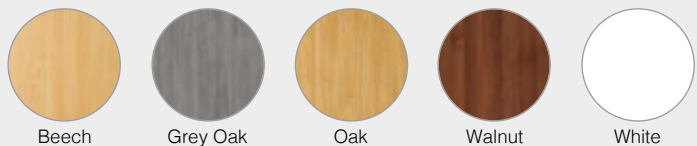

Beech

Grey Oak

Oak

Walnut

White



Straight Desks



CODE	W	D	H	RRP
MC608	800	600	725	£311
MC610	1000	600	725	£322
MC612	1200	600	725	£330
MC614	1400	600	725	£342
MC616	1600	600	725	£360

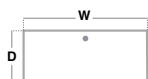

- Rectangular desks 600mm deep with cantilever leg frame
- Single cable access port positioned centrally on desktop



Straight Desks with Two Drawer Pedestal



CODE	W	D	H	RRP
MC612P2	1200	600	725	£465
MC614P2	1400	600	725	£482
MC616P2	1600	600	725	£495

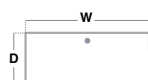

- Rectangular desks 600mm deep with cantilever frame & single cable access port
- Two drawer fixed pedestal which can be fitted to left or right hand side

Straight Desks with 2 x Two Drawer Pedestals



CODE	W	D	H	RRP
MC616P22	1600	600	725	£637



- Rectangular desks 600mm deep with cantilever frame & single cable access port
- 2 x two drawer fixed pedestals with shallow drawers and handles

HOME
OFFICE

OR

WORK
PLACE



Black (K)



Silver (S)



White (WH)



Beech (B)



Grey Oak (GO)



Oak (O)



Walnut (W)



White (WH)

Please add frame finish followed by desktop finish when ordering eg. MC616 with Black frame in White = MC616KWH

Straight Desks



CODE	W	D	H	RRP
MC8	800	800	725	£337
MC10	1000	800	725	£350
MC12	1200	800	725	£361
MC14	1400	800	725	£373
MC16	1600	800	725	£386
MC18	1800	800	725	£479



- Rectangular desks 800mm deep with cantilever frame & two cable access ports
- MC8 & MC10 only have one central cable access port

Straight Desks with Two Drawer Pedestal



CODE	W	D	H	RRP
MC12P2	1200	800	725	£542
MC14P2	1400	800	725	£559
MC16P2	1600	800	725	£569
MC18P2	1800	800	725	£664

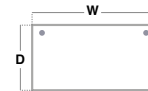

- Rectangular desks 800mm deep with cantilever frame & two cable access ports
- Two drawer fixed pedestal which can be fitted to left or right hand side

Straight Desks with Three Drawer Pedestal



CODE	W	D	H	RRP
MC12P3	1200	800	725	£542
MC14P3	1400	800	725	£559
MC16P3	1600	800	725	£569
MC18P3	1800	800	725	£664



- Rectangular desks 800mm deep with cantilever frame & two cable access ports
- Three drawer fixed pedestal which can be fitted to left or right hand side

Straight Desks with 2 x Two Drawer Pedestals



CODE	W	D	H	RRP
MC16P22	1600	800	725	£755
MC18P22	1800	800	725	£851



- Rectangular desks 800mm deep with cantilever frame & two cable access ports
- 2 x two drawer fixed pedestals with shallow and filing drawers with handles

Straight Desks with Two & Three Drawer Pedestals



CODE	W	D	H	RRP
MC16P23	1600	800	725	£755
MC18P23	1800	800	725	£851



- Rectangular desks 800mm deep with cantilever frame & two cable access ports
- Two and three drawer fixed pedestals which can be fitted to either side

Straight Desks with 2 x Three Drawer Pedestals



CODE	W	D	H	RRP
MC16P33	1600	800	725	£755
MC18P33	1800	800	725	£851



- Rectangular desks 800mm deep with cantilever frame & two cable access ports
- 2 x three drawer fixed pedestals with three shallow drawers



Black (K)



Silver (S)



White (WH)



Beech (B)



Grey Oak (GO)



Oak (O)



Walnut (W)



White (WH)

Please add frame finish followed by desktop finish when ordering eg. MC16 with Black frame in White = MC16KWH

Left Hand Wave Desks



CODE	W	D	H	d	RRP
MC14WL	1400	800	725	990	£433
MC16WL	1600	800	725	990	£454

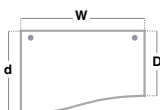

- Modern left hand wave desktops for a larger working area with cantilever frame
- Use individually or side-by-side with the right hand desk for a full wave effect

Left Hand Wave Desks with Two Drawer Pedestal



CODE	W	D	H	d	RRP
MC14WLP2	1400	800	725	990	£620
MC16WLP2	1600	800	725	990	£642

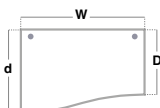

- Modern left hand wave desktops for a larger working area with cantilever frame
- Two drawer pedestal which is fixed to the 800mm deep end

Left Hand Wave Desks with Three Drawer Pedestal



CODE	W	D	H	d	RRP
MC14WLP3	1400	800	725	990	£620
MC16WLP3	1600	800	725	990	£642

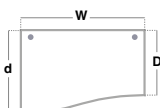

- Modern left hand wave desktops for a larger working area with cantilever frame
- Three drawer pedestal which is fixed to the 800mm deep end

Right Hand Wave Desks



CODE	W	D	H	d	RRP
MC14WR	1400	800	725	990	£433
MC16WR	1600	800	725	990	£454

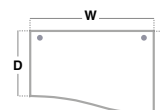

- Modern right hand wave desktops for a larger working area with cantilever frame
- Use individually or side-by-side with the left hand desk for a full wave effect

Right Hand Wave Desks with Two Drawer Pedestal



CODE	W	D	H	d	RRP
MC14WRP2	1400	800	725	990	£620
MC16WRP2	1600	800	725	990	£642

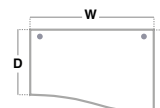

- Modern right hand wave desktops for a larger working area with cantilever frame
- Two drawer fixed pedestal which accepts A4 and foolscap files

Right Hand Wave Desks with Three Drawer Pedestal



CODE	W	D	H	d	RRP
MC14WRP3	1400	800	725	990	£620
MC16WRP3	1600	800	725	990	£642

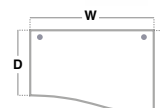

- Modern right hand wave desktops for a larger working area with cantilever frame
- Three drawer fixed pedestal with three shallow drawers



Black (K)



Silver (S)



White (WH)



Beech (B)



Grey Oak (GO)



Oak (O)



Walnut (W)



White (WH)

Please add frame finish followed by desktop finish when ordering eg. MC16WR with Black frame in White = MC16WRKWH

Left Hand Ergonomic Desks



CODE	W	D	H	w	d	RRP
MC14EL	1400	800	725	600	1200	£520
MC16EL	1600	800	725	600	1200	£560
MC18EL	1800	800	725	600	1200	£637

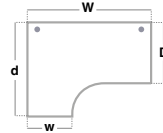

- Ergonomic left hand desks with cantilever frame and full leg return
- Ideal to fit into corners or cluster together to maximise office space

Left Hand Ergonomic Desks with Two Drawer Pedestal



CODE	W	D	H	w	d	RRP
MC16ELP2	1600	800	725	600	1200	£749
MC18ELP2	1800	800	725	600	1200	£823

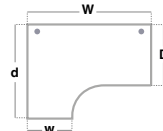

- Ergonomic left hand desks with cantilever frame and full leg return
- Two drawer pedestal which is fixed to the 800mm deep end

Left Hand Ergonomic Desks with Three Drawer Pedestal



CODE	W	D	H	w	d	RRP
MC16ELP3	1600	800	725	600	1200	£749
MC18ELP3	1800	800	725	600	1200	£823

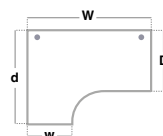

- Ergonomic left hand desks with cantilever frame and full leg return
- Three drawer pedestal which is fixed to the 800mm deep end

Right Hand Ergonomic Desks



CODE	W	D	H	w	d	RRP
MC14ER	1400	800	725	600	1200	£520
MC16ER	1600	800	725	600	1200	£560
MC18ER	1800	800	725	600	1200	£637

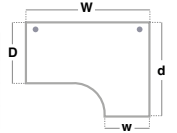

- Ergonomic right hand desks with cantilever frame and full leg return
- Ideal to fit into corners or cluster together to maximise office space

Right Hand Ergonomic Desks with Two Drawer Pedestal



CODE	W	D	H	w	d	RRP
MC16ERP2	1600	800	725	600	1200	£749
MC18ERP2	1800	800	725	600	1200	£823

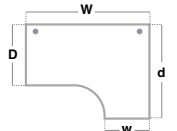

- Ergonomic right hand desks with cantilever frame and full leg return
- Two drawer fixed pedestal which accepts A4 and foolscap files

Right Hand Ergonomic Desks with Three Drawer Pedestal



CODE	W	D	H	w	d	RRP
MC16ERP3	1600	800	725	600	1200	£749
MC18ERP3	1800	800	725	600	1200	£823

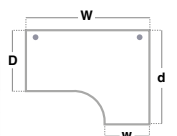

- Ergonomic right hand desks with cantilever frame and full leg return
- Three drawer fixed pedestal with three shallow drawers



Black (K)



Silver (S)



White (WH)



Beech (B)



Grey Oak (GO)



Oak (O)



Walnut (W)



White (WH)

Please add frame finish followed by desktop finish when ordering eg. **MC16ER** with Black frame in White = **MC16ERKWH**

MAESTRO 25

PANEL END LEG

The traditional panel end leg design, modesty panel and 25mm melamine desktops create a fully coordinated look and offer a practical, strong presence in any office environment.

A wide range of storage options are available from fixed and mobile pedestals to a selection of bookcases and cupboards, offering sensible storage solutions where efficiency and productivity are paramount.



EN527-1:2011
EN527-2:2016
EN1729-2:2012+A1:2015



Wood finishes

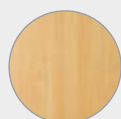

Beech

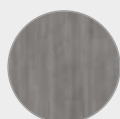

Grey Oak

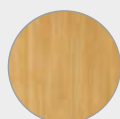

Oak

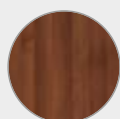

Walnut



White



Straight Desks



CODE	W	D	H	RRP
MP608	800	600	725	£311
MP610	1000	600	725	£322
MP612	1200	600	725	£330
MP614	1400	600	725	£342
MP616	1600	600	725	£360



- Rectangular desks 600mm deep with panel end leg
- Single cable access port positioned centrally on desktop

Straight Desks with Two Drawer Pedestal



CODE	W	D	H	RRP
MP612P2	1200	600	725	£465
MP614P2	1400	600	725	£482
MP616P2	1600	600	725	£495



- Rectangular desks 600mm deep with panel end leg & single cable access port
- Two drawer fixed pedestal which can be fitted to left or right hand side

Straight Desks with 2 x Two Drawer Pedestals



CODE	W	D	H	RRP
MP616P22	1600	600	725	£637



- Rectangular desks 600mm deep with panel end leg & single cable access port
- 2 x two drawer fixed pedestals with shallow drawers and handles



HOME
OFFICE

OR

WORK
PLACE



Beech (B)



Grey Oak (GO)



Oak (O)



Walnut (W)



White (WH)

Please add desktop finish when ordering eg. MP616 in Oak = MP616O

Straight Desks



CODE	W	D	H	RRP
MP8	800	800	725	£337
MP10	1000	800	725	£350
MP12	1200	800	725	£361
MP14	1400	800	725	£373
MP16	1600	800	725	£386
MP18	1800	800	725	£479

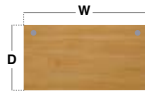

- Rectangular desks 800mm deep with panel end legs & two cable access ports
- MP8 & MP10 only have one central cable access port

Straight Desks with Two Drawer Pedestal



CODE	W	D	H	RRP
MP12P2	1200	800	725	£542
MP14P2	1400	800	725	£559
MP16P2	1600	800	725	£569
MP18P2	1800	800	725	£664

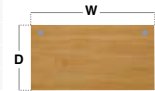

- Rectangular desks 800mm deep with panel end legs & two cable access ports
- Two drawer fixed pedestal which can be fitted to left or right hand side

Straight Desks with Three Drawer Pedestal



CODE	W	D	H	RRP
MP12P3	1200	800	725	£542
MP14P3	1400	800	725	£559
MP16P3	1600	800	725	£569
MP18P3	1800	800	725	£664



- Rectangular desks 800mm deep with panel end legs & two cable access ports
- Three drawer fixed pedestal which can be fitted to left or right hand side

Straight Desks with 2 x Two Drawer Pedestals



CODE	W	D	H	RRP
MP16P22	1600	800	725	£755
MP18P22	1800	800	725	£851



- Rectangular desks 800mm deep with panel end legs & two cable access ports
- 2 x two drawer fixed pedestals with shallow and filing drawers with handles

Straight Desks with Two & Three Drawer Pedestals



CODE	W	D	H	RRP
MP16P23	1600	800	725	£755
MP18P23	1800	800	725	£851



- Rectangular desks 800mm deep with panel end legs & two cable access ports
- Two and three drawer fixed pedestals which can be fitted to either side

Straight Desks with 2 x Three Drawer Pedestals



CODE	W	D	H	RRP
MP16P33	1600	800	725	£755
MP18P33	1800	800	725	£851



- Rectangular desks 800mm deep with panel end legs & two cable access ports
- 2 x three drawer fixed pedestals with three shallow drawers



Beech (B)



Grey Oak (GO)



Oak (O)



Walnut (W)



White (WH)

Please add desktop finish when ordering eg. MP16 in Oak = MP16O

Maestro 25 | Contract

Left Hand Wave Desks



CODE	W	D	H	d	RRP
MP14WL	1400	800	725	990	£433
MP16WL	1600	800	725	990	£454

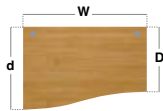

- Modern left hand wave desktops for a larger working area with panel end leg
- Use individually or side-by-side with the right hand desk for a full wave effect

Left Hand Wave Desks with Two Drawer Pedestal



CODE	W	D	H	d	RRP
MP14WLP2	1400	800	725	990	£620
MP16WLP2	1600	800	725	990	£642

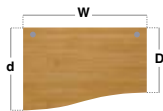

- Modern left hand wave desktops for a larger working area with panel end leg
- Two drawer pedestal which is fixed to the 800mm deep end

Left Hand Wave Desks with Three Drawer Pedestal



CODE	W	D	H	d	RRP
MP14WLP3	1400	800	725	990	£620
MP16WLP3	1600	800	725	990	£642

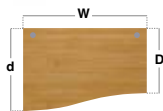

- Modern left hand wave desktops for a larger working area with panel end leg
- Three drawer pedestal which is fixed to the 800mm deep end

Right Hand Wave Desks



CODE	W	D	H	d	RRP
MP14WR	1400	800	725	990	£433
MP16WR	1600	800	725	990	£454

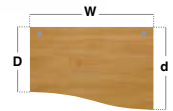

- Modern right hand wave desktops for a larger working area with panel end leg
- Use individually or side-by-side with the left hand desk for a full wave effect

Right Hand Wave Desks with Two Drawer Pedestal



CODE	W	D	H	d	RRP
MP14WRP2	1400	800	725	990	£620
MP16WRP2	1600	800	725	990	£642

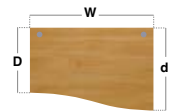

- Modern right hand wave desktops for a larger working area with panel end leg
- Two drawer fixed pedestal which accepts A4 and foolscap files

Right Hand Wave Desks with Three Drawer Pedestal



CODE	W	D	H	d	RRP
MP14WRP3	1400	800	725	990	£620
MP16WRP3	1600	800	725	990	£642

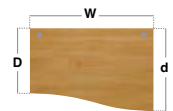

- Modern right hand wave desktops for a larger working area with panel end leg
- Three drawer fixed pedestal with three shallow drawers



Beech (B)



Grey Oak (GO)



Oak (O)



Walnut (W)



White (WH)

Please add desktop finish when ordering eg. MP16WL in Oak = MP16WLO

Left Hand Ergonomic Desks



CODE	W	D	H	w	d	RRP
MP14EL	1400	800	725	600	1200	£520
MP16EL	1600	800	725	600	1200	£560
MP18EL	1800	800	725	600	1200	£637

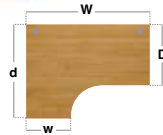

- Ergonomic left hand desktops with panel end legs and two cable access ports
- Ideal to fit into corners or cluster together to maximise office space

Left Hand Ergonomic Desks with Two Drawer Pedestal



CODE	W	D	H	w	d	RRP
MP16ELP2	1600	800	725	600	1200	£749
MP18ELP2	1800	800	725	600	1200	£823

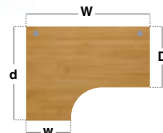

- Ergonomic left hand desktops with panel end leg and full leg return
- Two drawer pedestal which is fixed to the 800mm deep end

Left Hand Ergonomic Desks with Three Drawer Pedestal



CODE	W	D	H	w	d	RRP
MP16ELP3	1600	800	725	600	1200	£749
MP18ELP3	1800	800	725	600	1200	£823

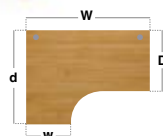

- Ergonomic left hand desktops with panel end leg and full leg return
- Three drawer pedestal which is fixed to the 800mm deep end

Right Hand Ergonomic Desks



CODE	W	D	H	w	d	RRP
MP14ER	1400	800	725	600	1200	£520
MP16ER	1600	800	725	600	1200	£560
MP18ER	1800	800	725	600	1200	£637

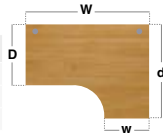

- Ergonomic right hand desktops with panel end legs and two cable access ports
- Ideal to fit into corners or cluster together to maximise office space

Right Hand Ergonomic Desks with Two Drawer Pedestal



CODE	W	D	H	w	d	RRP
MP16ERP2	1600	800	725	600	1200	£749
MP18ERP2	1800	800	725	600	1200	£823

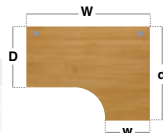

- Ergonomic right hand desktops with panel end leg and full leg return
- Two drawer fixed pedestal which accepts A4 and foolscap files

Right Hand Ergonomic Desks with Three Drawer Pedestal



CODE	W	D	H	w	d	RRP
MP16ERP3	1600	800	725	600	1200	£749
MP18ERP3	1800	800	725	600	1200	£823

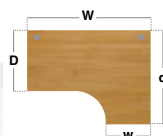

- Ergonomic right hand desktops with panel end leg and full leg return
- Three drawer fixed pedestal with three shallow drawers



Beech (B)



Grey Oak (GO)



Oak (O)



Walnut (W)



White (WH)

Please add desktop finish when ordering eg. MP16EL in Oak = MP16ELO

MAESTRO 25

H-FRAME

The fully welded H-frame leg design ensures a strong and stable workstation finished in black, silver or white to complement the 25mm melamine desktops.

A wide range of storage options are available from fixed and mobile pedestals to a selection of bookcases and cupboards, offering sensible storage solutions where efficiency and productivity are paramount.



EN527-1:2011
EN527-2:2016
EN1729-2:2012+A1:2015



Desk frame colours



Black

Silver

White

Wood finishes

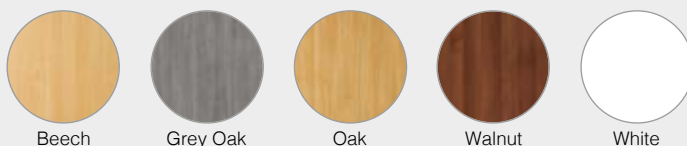

Beech

Grey Oak

Oak

Walnut

White



Straight Desks



CODE	W	D	H	RRP
MH608	800	600	725	£246
MH610	1000	600	725	£250
MH612	1200	600	725	£264
MH614	1400	600	725	£281
MH616	1600	600	725	£290



- Rectangular desks 600mm deep with H-frame legs
- Single cable access port positioned centrally on desktop



Straight Desks with Two Drawer Pedestal



CODE	W	D	H	RRP
MH612P2	1200	600	725	£403
MH614P2	1400	600	725	£418
MH616P2	1600	600	725	£430

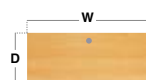

- Rectangular desks 600mm deep with H-frame legs & single cable access port
- Two drawer fixed pedestal which can be fitted to left or right hand side

Straight Desks with 2 x Two Drawer Pedestals



CODE	W	D	H	RRP
MH616P22	1600	600	725	£567



- Rectangular desks 600mm deep with H-frame legs & single cable access port
- 2 x two drawer fixed pedestals with shallow drawers and handles

HOME
OFFICE

OR

WORK
PLACE



Black (K)



Silver (S)



White (WH)



Beech (B)



Grey Oak (GO)



Oak (O)



Walnut (W)



White (WH)

Please add frame finish followed by desktop finish when ordering eg. **MH616** with Black frame in Beech = **MH616KB**

Straight Desks



CODE	W	D	H	RRP
MH8	800	800	725	£274
MH10	1000	800	725	£278
MH12	1200	800	725	£290
MH14	1400	800	725	£308
MH16	1600	800	725	£321
MH18	1800	800	725	£409



- Rectangular desks 800mm deep with H-Frame legs
- MH8 & MH10 only have one central cable access port

Straight Desks with Two Drawer Pedestal



CODE	W	D	H	RRP
MH12P2	1200	800	725	£482
MH14P2	1400	800	725	£495
MH16P2	1600	800	725	£509
MH18P2	1800	800	725	£598



- Rectangular desks 800mm deep with H-Frame legs & 2 cable access ports
- Two drawer fixed pedestal which can be fitted to left or right hand side

Straight Desks with Three Drawer Pedestal



CODE	W	D	H	RRP
MH12P3	1200	800	725	£482
MH14P3	1400	800	725	£495
MH16P3	1600	800	725	£509
MH18P3	1800	800	725	£598



- Rectangular desks 800mm deep with H-Frame legs & 2 cable access ports
- Three drawer fixed pedestal which can be fitted to left or right hand side

Straight Desks with 2 x Two Drawer Pedestals



CODE	W	D	H	RRP
MH16P22	1600	800	725	£697
MH18P22	1800	800	725	£787



- Rectangular desks 800mm deep with H-frame leg & two cable access ports
- 2 x two drawer fixed pedestals with shallow and deep filing drawers

Straight Desks with Two & Three Drawer Pedestals



CODE	W	D	H	RRP
MH16P23	1600	800	725	£697
MH18P23	1800	800	725	£787



- Rectangular desks 800mm deep with H-Frame leg set & 2 cable access ports
- Two and three drawer fixed pedestals which can be fitted to either side

Straight Desks with 2 x Three Drawer Pedestals



CODE	W	D	H	RRP
MH16P33	1600	800	725	£697
MH18P33	1800	800	725	£787

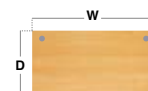

- Rectangular desks 800mm deep with H-Frame leg set & 2 cable access ports
- 2 x three drawer fixed pedestals with three shallow drawers



Black (K)



Silver (S)



White (WH)



Beech (B)



Grey Oak (GO)



Oak (O)



Walnut (W)



White (WH)

Please add frame finish followed by desktop finish when ordering eg. **MH16** with Black frame in Beech = **MH16KB**

CONTRACT 25

VALUE DESKING RANGE

A good office desk is a key component of any work environment and Contract 25 is a versatile, entry-level design that refuses to go out of style.

Sturdy enough to withstand a fast-paced 9 to 5 lifestyle yet sleek in appearance, the Contract 25 range features primary storage options in the style of fixed pedestals with finger pull handles for all those extra gadgets and out of sight, out of mind documents.



Desk frame colours



Wood finishes

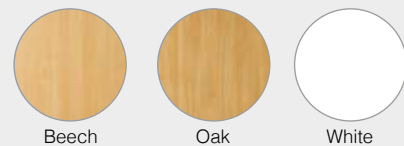



Contract 25 Cantilever | Contract

Straight Desks



CODE	W	D	H	RRP
CC8S	800	800	725	£251
CC10S	1000	800	725	£257
CC12S	1200	800	725	£265
CC14S	1400	800	725	£273
CC16S	1600	800	725	£286
CC18S	1800	800	725	£313



- Rectangular desks 800mm deep with single upright legs & two cable ports
- CC8S & CC10S only have one cable access port

Straight Desks with Two Drawer Pedestal



CODE	W	D	H	RRP
CC12S2	1200	800	725	£453
CC14S2	1400	800	725	£459
CC16S2	1600	800	725	£471
CC18S2	1800	800	725	£486

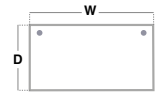

- Rectangular desks 800mm deep with single upright cantilever legs
- Two drawer fixed pedestal which can be fitted to left or right hand side

Straight Desks with Three Drawer Pedestal



CODE	W	D	H	RRP
CC12S3	1200	800	725	£453
CC14S3	1400	800	725	£459
CC16S3	1600	800	725	£471
CC18S3	1800	800	725	£486



- Rectangular desks 800mm deep with single upright cantilever legs
- Three drawer fixed pedestal which can be fitted to left or right hand side

Straight Desks with 2 x Two Drawer Pedestals



CODE	W	D	H	RRP
CC16S22	1600	800	725	£649
CC18S22	1800	800	725	£693



- Rectangular desks 800mm deep with single upright cantilever legs
- 2 x two drawer fixed pedestals which accept A4 and foolscap files

Straight Desks with Two & Three Drawer Pedestals



CODE	W	D	H	RRP
CC16S23	1600	800	725	£649
CC18S23	1800	800	725	£693



- Rectangular desks 800mm deep with single upright cantilever legs
- Two and three drawer fixed pedestals which can be fitted to either side

Straight Desks with 2 x Three Drawer Pedestals



CODE	W	D	H	RRP
CC16S33	1600	800	725	£649
CC18S33	1800	800	725	£693



- Rectangular desks 800mm deep with single upright cantilever legs
- 2 x three drawer fixed pedestals with matching finger pull handles



Please add frame finish followed by desktop finish when ordering eg. CC16S with Silver frame in White = CC16S-S-WH

Contract 25 Cantilever | Contract

Left Hand Ergonomic Desks

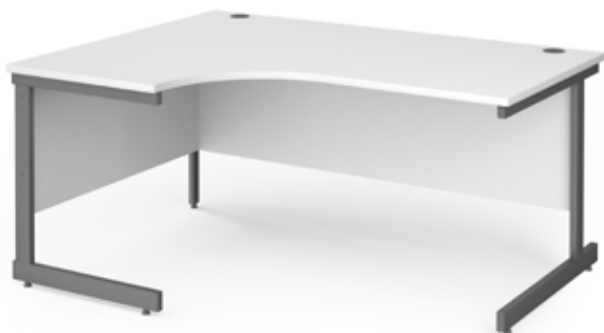

CODE	W	D	H	w	d	RRP
CC14EL	1400	800	725	600	1200	£486
CC16EL	1600	800	725	600	1200	£526
CC18EL	1800	800	725	600	1200	£584

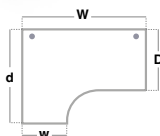

- Ergonomic left hand desktops with single upright legs & two cable ports
- Ideal to fit into corners or cluster together to maximise office space

Right Hand Ergonomic Desks

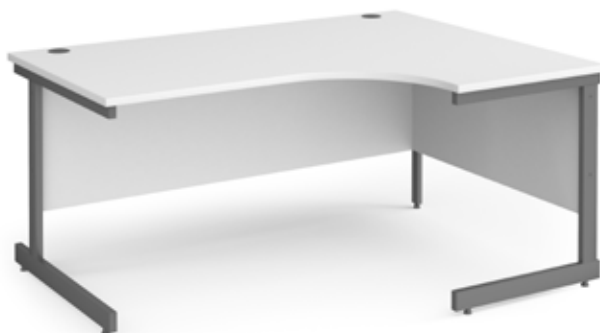

CODE	W	D	H	w	d	RRP
CC14ER	1400	800	725	600	1200	£486
CC16ER	1600	800	725	600	1200	£526
CC18ER	1800	800	725	600	1200	£584

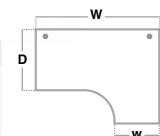

- Ergonomic right hand desktops with single upright legs & two cable ports
- Space saving design to fit in rooms which lack space

Left Hand Ergonomic Desks with Two Drawer Pedestal



CODE	W	D	H	w	d	RRP
CC16EL2	1600	800	725	600	1200	£705
CC18EL2	1800	800	725	600	1200	£768

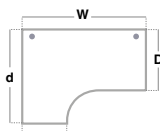

- Ergonomic left hand desktops with single upright legs & two cable ports
- Two drawer fixed pedestal which accept A4 and foolscap files

Right Hand Ergonomic Desks with Two Drawer Pedestal



CODE	W	D	H	w	d	RRP
CC16ER2	1600	800	725	600	1200	£705
CC18ER2	1800	800	725	600	1200	£768

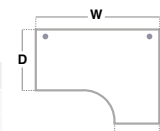

- Ergonomic right hand desktops with single upright legs & two cable ports
- Filing drawer has metal rails for folders to clip on front to back

Left Hand Ergonomic Desks with Three Drawer Pedestal

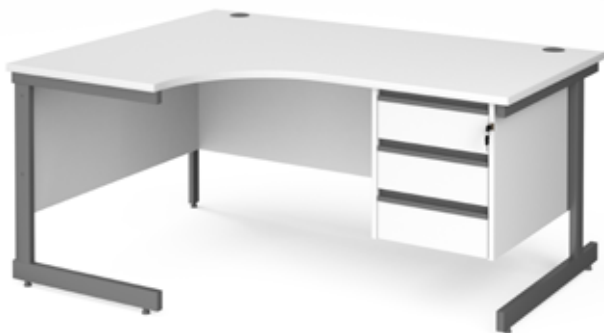

CODE	W	D	H	w	d	RRP
CC16EL3	1600	800	725	600	1200	£705
CC18EL3	1800	800	725	600	1200	£768

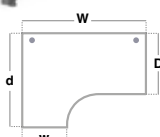

- Ergonomic left hand desktops with single upright legs & two cable ports
- Three drawer fixed pedestal with matching finger pull handles

Right Hand Ergonomic Desks with Three Drawer Pedestal

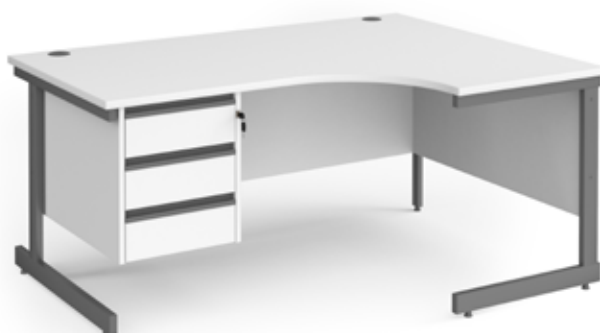

CODE	W	D	H	w	d	RRP
CC16ER3	1600	800	725	600	1200	£705
CC18ER3	1800	800	725	600	1200	£768

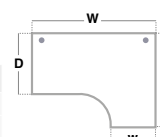

- Ergonomic right hand desktops with single upright legs & two cable ports
- Internal drawer dimensions 475mm wide, 80mm high and 475mm deep



Please add frame finish followed by desktop finish when ordering eg. **CC16EL** with Graphite frame in White = **CC16EL-G-WH**

Contract 25 Panel Leg | Contract

Straight Desks



CODE	W	D	H	RRP
CP8S	800	800	725	£251
CP10S	1000	800	725	£257
CP12S	1200	800	725	£265
CP14S	1400	800	725	£273
CP16S	1600	800	725	£286
CP18S	1800	800	725	£313



- Rectangular desks 800mm deep with panel ends and two cable access ports
- CP8S & CP10S only have one cable access port

Straight Desks with Two Drawer Pedestal



CODE	W	D	H	RRP
CP12S2	1200	800	725	£453
CP14S2	1400	800	725	£462
CP16S2	1600	800	725	£471
CP18S2	1800	800	725	£498



- Rectangular desks 800mm deep with panel ends and two cable access ports
- Two drawer fixed pedestal which can be fitted to left or right hand side

Straight Desks with Three Drawer Pedestal



CODE	W	D	H	RRP
CP12S3	1200	800	725	£453
CP14S3	1400	800	725	£462
CP16S3	1600	800	725	£471
CP18S3	1800	800	725	£498



- Rectangular desks 800mm deep with panel ends and two cable access ports
- Three drawer fixed pedestal which can be fitted to left or right hand side

Straight Desks with 2 x Two Drawer Pedestals



CODE	W	D	H	RRP
CP16S22	1600	800	725	£649
CP18S22	1800	800	725	£679



- Rectangular desks 800mm deep with panel ends and two cable access ports
- 2 x two drawer fixed pedestals which accept A4 and foolscap files

Straight Desks with Two & Three Drawer Pedestals



CODE	W	D	H	RRP
CP16S23	1600	800	725	£649
CP18S23	1800	800	725	£679



- Rectangular desks 800mm deep with panel ends and two cable access ports
- Two and three drawer fixed pedestals which can be fitted to either side

Straight Desks with 2 x Three Drawer Pedestals



CODE	W	D	H	RRP
CP16S33	1600	800	725	£649
CP18S33	1800	800	725	£679



- Rectangular desks 800mm deep with panel ends and two cable access ports
- 2 x three drawer fixed pedestals with silver or graphite finger pull handles



Graphite (G)



Silver (S)



Beech (B)



Oak (O)



White (WH)

Please add handle finish followed by desktop finish when ordering eg. CP16S with Silver handles in Beech = CP16S-S-B

Contract 25 Panel Leg | Contract

Left Hand Ergonomic Desks



CODE	W	D	H	w	d	RRP
CP14EL	1400	800	725	600	1200	£498
CP16EL	1600	800	725	600	1200	£526
CP18EL	1800	800	725	600	1200	£584

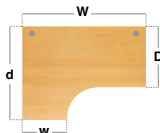

- Ergonomic left hand desktops with panel ends and silver or graphite corner leg
- Ideal to fit into corners or cluster together to maximise office space

Right Hand Ergonomic Desks



CODE	W	D	H	w	d	RRP
CP14ER	1400	800	725	600	1200	£498
CP16ER	1600	800	725	600	1200	£526
CP18ER	1800	800	725	600	1200	£584

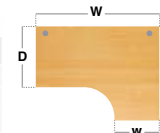

- Ergonomic right hand desktops with panel ends and silver or graphite corner leg
- Space saving design to fit in rooms which lack space

Left Hand Ergonomic Desks with Two Drawer Pedestal



CODE	W	D	H	w	d	RRP
CP16EL2	1600	800	725	600	1200	£727
CP18EL2	1800	800	725	600	1200	£755

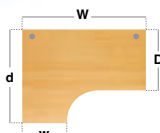

- Ergonomic left hand desktops with panel ends and silver or graphite corner leg
- Two drawer fixed pedestal which accept A4 and foolscap files

Right Hand Ergonomic Desks with Two Drawer Pedestal



CODE	W	D	H	w	d	RRP
CP16ER2	1600	800	725	600	1200	£727
CP18ER2	1800	800	725	600	1200	£755

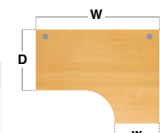

- Ergonomic right hand desktops with panel ends and silver or graphite corner leg
- Filing drawer has metal rails for folders to clip on front to back

Left Hand Ergonomic Desks with Three Drawer Pedestal



CODE	W	D	H	w	d	RRP
CP16EL3	1600	800	725	600	1200	£727
CP18EL3	1800	800	725	600	1200	£755

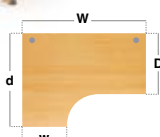

- Ergonomic left hand desktops with panel ends and silver or graphite corner leg
- Three drawer fixed pedestal with silver or graphite finger pull handles

Right Hand Ergonomic Desks with Three Drawer Pedestal



CODE	W	D	H	w	d	RRP
CP16ER3	1600	800	725	600	1200	£727
CP18ER3	1800	800	725	600	1200	£755

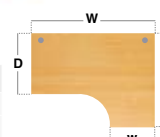

- Ergonomic right hand desktops with panel ends and silver or graphite corner leg
- Internal drawer dimensions 475mm wide, 80mm high and 475mm deep



Graphite (G)



Silver (S)



Beech (B)



Oak (O)



White (WH)

Please add handle finish followed by desktop finish when ordering eg. CP16EL with Graphite handles in Beech = CP16EL-G-B

Contract 25 H Frame Leg | Contract

Straight Desks



CODE	W	D	H	RRP
CH8S	800	800	725	£169
CH10S	1000	800	725	£183
CH12S	1200	800	725	£196
CH14S	1400	800	725	£204
CH16S	1600	800	725	£218
CH18S	1800	800	725	£246



- Rectangular desks 800mm deep with H-Frame legs & two cable access ports
- CH8S & CH10S only have one cable access port

Straight Desks with Two Drawer Pedestal



CODE	W	D	H	RRP
CH12S2	1200	800	725	£366
CH14S2	1400	800	725	£376
CH16S2	1600	800	725	£389
CH18S2	1800	800	725	£471

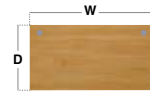

- Rectangular desks 800mm deep with H-Frame legs
- Two drawer fixed pedestal which can be fitted to left or right hand side

Straight Desks with Three Drawer Pedestal



CODE	W	D	H	RRP
CH12S3	1200	800	725	£366
CH14S3	1400	800	725	£376
CH16S3	1600	800	725	£389
CH18S3	1800	800	725	£471



- Rectangular desks 800mm deep with H-Frame legs
- Three drawer fixed pedestal which can be fitted to left or right hand side

Straight Desks with 2 x Two Drawer Pedestals



CODE	W	D	H	RRP
CH16S22	1600	800	725	£584
CH18S22	1800	800	725	£616



- Rectangular desks 800mm deep with H-Frame legs
- 2 x two drawer fixed pedestals which accept A4 and foolscap files

Straight Desks with Two & Three Drawer Pedestals



CODE	W	D	H	RRP
CH16S23	1600	800	725	£584
CH18S23	1800	800	725	£616



- Rectangular desks 800mm deep with H-Frame legs
- Two and three drawer fixed pedestals which can be fitted to either side

Straight Desks with 2 x Three Drawer Pedestals



CODE	W	D	H	RRP
CH16S33	1600	800	725	£584
CH18S33	1800	800	725	£616

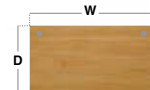

- Rectangular desks 800mm deep with H-Frame legs
- 2 x three drawer fixed pedestals with matching finger pull handles



Graphite (G)



Silver (S)



Beech (B)



Oak (O)



White (WH)

Please add frame finish followed by desktop finish when ordering eg. CH16S with Silver frame in Oak = CH16S-S-O

3 frame styles
3 wood finishes
2 Leg finishes
2 top shapes
2 pedestal options

Boasting a wide range of configurations and desk options, the Contract 25 range is available with cantilever leg, H-Frame leg and panel end leg designs to suit all requirements for function, style and most importantly budget.

Contract 25 is the perfect entry into 25mm desking, featuring a variety of sizes, shapes, and storage solutions for any work style or office arrangement.



DESKS

ANSON

EXECUTIVE OFFICE

Anson is a premium executive range that reflects a leader's demand for an elevated aesthetic, whether in a managers office or boardroom setting.

The desks provide plenty of worktop space and are available in a choice of two-tone designer leg frames or with a panel end profile, with a matching pedestal and cupboards that offer all important storage space and the collection is completed by meeting and boardroom tables that lend itself to decision making at the highest level.



Desk frame colours



Black/Silver
A-frame

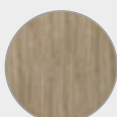

Barcelona
Walnut
Panel End

Wood finishes

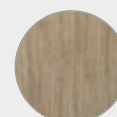

Barcelona
Walnut



Executive Panel End Desk



CODE	W	D	H	RRP
ANS-ED	2000	1000	725	£1150

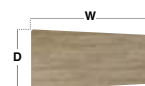

- Elegant, stylish executive desk with modesty panel
- Angular panel end legs in matching finish for a designer look and feel

Executive Panel End Desk with Return



CODE	W	D	H	w	d	RRP
ANS-RD	2200	1000	725	500	2000	£2200

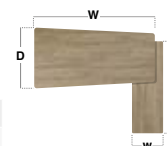

- Executive desk 2000mm wide complete with 1600mm return desk
- Return can be fitted to either side to extend the work area

Credenza



CODE	W	D	H	RRP
ANS-CRD	1600	550	800	£1000

- Stand alone credenza unit with cupboards, drawers and open storage
- Suitable to add a fridge max size 460w x 430d x 670h



Barcelona Walnut (BW)

Please add desktop finish when ordering eg. **ANS-ED** in Barcelona Walnut = **ANS-ED-BW**

Executive A-frame Desk



CODE	W	D	H	RRP
ANS-DED	2000	1000	725	£1750



- Elegant, stylish executive desk with modesty panel
- Sleek, stylish A-frame legs in black and silver

Executive A-frame Desk with Return



CODE	W	D	H	w	d	RRP
ANS-DRD	2200	1000	725	500	2000	£2750

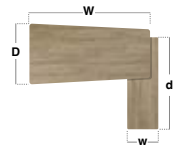

- Executive desk 2000mm wide complete with 1600mm return desk
- Return can be fitted to either side to extend the work area

Two Drawer Pedestal



CODE	W	D	H	RRP
ANS-PED	400	500	500	£400

- Under desk storage solution to keep the work area uncluttered
- Three shallow drawers with white steel drawer sides



Barcelona Walnut (BW)

Please add desktop finish when ordering eg. **ANS-DED** in Barcelona Walnut = **ANS-DED-BW**



Anson offers a range of professional desks, in-line credenzas, and integrated vertical storage, combining function with a beautiful aesthetic. Perfect for managers seeking sophistication, its coordinated workspace and storage solutions enhance any office with prestige and style.

The workspace needs options and Anson offers plenty of them with stylish storage solutions

A truly comprehensive solution that supports executive, managerial and home offices

Integrated vertical, modular storage creates a space with a beautiful aesthetic

Cupboards supplied empty but can be fitted with all systems internal fittings, see page 155

ANS-MBK



ANS-CBL



ANS-CBH

BOOKCASE

CODE	W	D	H	RRP
ANS-MBK	1020	300	800	£250

CUPBOARDS

CODE	W	D	H	RRP
ANS-CBL	1020	550	800	£475
ANS-CBH	1020	550	1600	£625



Barcelona Walnut (BW)

Please add desktop finish when ordering eg. **ANS-MBK** in Barcelona Walnut = **ANS-MBK-BW**



Anson boardroom tables provide a distinctive statement of quality, strength, and precision, ideal for making the right impression in meetings. Designed for boardrooms and conference rooms, the Anson table range provides a sophisticated executive table solution.

Makes a bold, visual statement in any conference room and create a space with a beautiful aesthetic

Circular, square and rectangular table top options with clean lines and an elegant, sleek design

Offer a versatile whole room solution and bring a timeless appeal to the executive space

Two-tone designer leg frames complement the stylish Barcelona Walnut table tops



CODE	DESCRIPTION	W	D	H	RRP
ANS-TBC12	Circular	1200	1200	725	£1300
ANS-TBS12	Square	1200	1200	725	£1300
ANS-TBR22	Rectangular	2200	1200	725	£1500



Barcelona Walnut (BW)

Please add desktop finish when ordering eg. ANS-TBC12 in Barcelona Walnut = ANS-TBC12-BW



HOME OFFICE

PROFESSIONAL HOME WORKING SOLUTIONS

HAIRPIN LEG



TIKAL
102

A-FRAME



SPARTA
103

SLEIGH FRAME



CAIRO
104

WOODEN LEG



GIZA
105

STORAGE & ACCESSORIES



CUBE
106



Hairpin Leg Desks



CODE	W	D	H	RRP
TK610	1000	600	730	£165
TK612	1200	600	730	£175

- Rectangular desk 600mm deep with black hairpin legs
- Scalloped cutouts in the back of the desktop

Hairpin Leg Desk with Pedestal



Internal Dimensions			
	400 w		
525 d		230 h	
380 d		400 h	

CODE	W	D	H	RRP
TK614P	1400	600	730	£320

- Rectangular desk 600mm deep with black hairpin legs
- 1400mm wide desk with support pedestal which can be fitted to either side

Hairpin Leg Desk with Pedestal & Drawers



Internal Dimensions			
	400 w		
525 d		230 h	
325 d		160 h	
		160 h	

CODE	W	D	H	RRP
TK614P-D	1400	600	730	£525

- Rectangular desk 600mm deep with black hairpin legs
- 1400mm wide desk with support pedestal and set of drawers

Hairpin Leg Desk with Pedestal & Cupboard Door



Internal Dimensions			
	400 w		
525 d		230 h	
		190 h	
345 d		190 h	

CODE	W	D	H	RRP
TK614P-C	1400	600	730	£350

- Rectangular desk 600mm deep with black hairpin legs
- 1400mm wide desk with support pedestal and cupboard door with shelf



Kendal Oak (KO)



Onyx Grey (OG)



White (WH)



Kendal Oak (KO)



Onyx Grey (OG)



White (WH)

For desks, add desktop finish when ordering eg. **TK612** with White top = **TK612-WH**

For desks with support pedestals, add desktop finish followed by insert finish when ordering eg. **TK614P-D** in White with drawers in Oak = **TK614P-D-WH-KO**

A-Frame Leg Desks



CODE	W	D	H	RRP
SP610	1000	600	730	£300
SP612	1200	600	730	£325
SP614	1400	600	730	£350

- Rectangular desk 600mm deep with charcoal A-frame legs
- Scalloped cutouts in the back of the desktop

A-Frame Leg Desk with Pedestal



CODE	W	D	H	RRP
SP614P	1400	600	730	£395

- Rectangular desk 600mm deep with charcoal A-frame legs
- 1400mm wide desk with support pedestal which can be fitted to either side

Internal Dimensions

400 w

525 d 230 h

380 d 400 h

A-Frame Leg Desk with Pedestal & Drawers



CODE	W	D	H	RRP
SP614P-D	1400	600	730	£560

- Rectangular desk 600mm deep with charcoal A-frame legs
- 1400mm wide desk with support pedestal and set of drawers

Internal Dimensions

400 w

525 d 230 h

325 d 160 h

160 h

A-Frame Leg Desk with Pedestal & Cupboard Door



CODE	W	D	H	RRP
SP614P-C	1400	600	730	£410

- Rectangular desk 600mm deep with charcoal A-frame legs
- 1400mm wide desk with support pedestal and cupboard door with shelf

Internal Dimensions

400 w

525 d 230 h

345 d 190 h

190 h



For desks, add desktop finish when ordering eg. SP614 with Grey top = SP614-OG

For desks with support pedestals, add desktop finish followed by insert finish when ordering eg. SP614P-C in Grey with cupboard door in White = SP614P-C-OG-WH

Cairo | Sleigh Frame Desks

Sleigh Frame Desks



CODE	W	D	H	RRP
CR610	1000	600	730	£450
CR612	1200	600	730	£495
CR614	1400	600	730	£525

- Rectangular desk 600mm deep with ancient brass sleigh frame
- Scalloped cutouts in the back of the desktop

Sleigh Frame Desk with Pedestal



CODE	W	D	H	RRP
CR614P	1400	600	730	£460

- Rectangular desk 600mm deep with ancient brass sleigh frame
- 1400mm wide desk with support pedestal which can be fitted to either side

Internal Dimensions	
400 w	
525 d	230 h
380 d	400 h

Sleigh Frame Desk with Pedestal & Drawers



CODE	W	D	H	RRP
CR614P-D	1400	600	730	£580

- Rectangular desk 600mm deep with ancient brass sleigh frame
- 1400mm wide desk with support pedestal and set of drawers

Internal Dimensions	
400 w	
525 d	230 h
325 d	160 h
	160 h



CODE	W	D	H	RRP
CR614P-C	1400	600	730	£510

- Rectangular desk 600mm deep with ancient brass sleigh frame
- 1400mm wide desk with support pedestal and cupboard door with shelf

Internal Dimensions	
400 w	
525 d	230 h
345 d	190 h
	190 h



Kendal Oak (KO)



Onyx Grey (OG)



White (WH)



Kendal Oak (KO)



Onyx Grey (OG)



White (WH)

For desks, add desktop finish when ordering eg. CR614 with Oak top = CR614-KO

For desks with support pedestals, add desktop finish followed by insert finish when ordering eg. CR614P-D in Oak with drawers in Grey = CR614P-D-KO-GO

Giza | Wooden Leg Desks

Wooden Leg Desk 1000mm



CODE	W	D	H	RRP
GZ610	1000	600	750	£550

- Rectangular desk 600mm deep with oak wooden legs
- Scalloped cutouts in the back of the desktop

Wooden Leg Desk 1200mm



CODE	W	D	H	RRP
GZ612	1200	600	750	£570

- Rectangular desk 600mm deep with oak wooden legs
- Sturdy white metal underframe for stability

Wooden Leg Desk 1400mm



CODE	W	D	H	RRP
GZ614	1400	600	750	£590

- Rectangular desk 600mm deep with oak wooden legs
- Sleek, curved lines of the legs with adjustable feet



Kendal Oak (KO)



Onyx Grey (OG)



White (WH)

For desks, add desktop finish when ordering eg. **GZ614** with White top = **GZ614-WH**

How to guide

Offering versatile and practical storage solutions, our universal cube wooden storage will keep your home office organised and looking neat and tidy.

Shelves, cupboard doors and drawers with brown leather loop handles can be ordered in any of the 3 wood finishes to be positioned in any cube, to mix and match finishes and storage options to suit any space.

UCS3-2
6 cube unit supplied with glides

CODE	W	D	H	RRP
UCS2-2	860	400	875	£274
UCS3-2	860	400	1295	£354

UCS2-2
4 cube unit supplied with glides



CSI-C
Can be fitted to the left or right hand side of cube, supplied with leather strap handle

CSI-D
Metal box drawer surrounds with 300 x 150mm internals, supplied with leather strap handles

CSI-CS
Can be fitted to the left or right hand side of cube, supplied with leather strap handles

CODE	DESCRIPTION	RRP
CSI-D	Drawers	£250
CSI-C	Cupboard door	£58
CSI-CS	Cupboard & shelf	£75
CSI-S	Single shelf	£32

CSI-S
Internal shelf

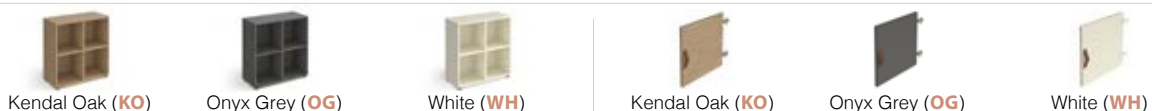

For cubes, add storage finish when ordering eg. **UCS2-1** in Grey = **UCS2-1-OG**
For Internals, add finish when ordering eg. **CSI-CS** in White = **CSI-CS-WH**

Cube Storage | Design Your Own



UCS3-2



UCS3-2
CSI-C x 2
CSI-D x 2



UCS3-2
CSI-C x 2
CSI-D x 2
DH-AF-62366

STEP 1

Select your carcass, style and finish

STEP 2

Select internal fittings

STEP 3

Add foot design to match furniture range if desired



Tikal

CODE	RRP
DH-HP4S-K	£50

• Pack of 4



Sparta

CODE	RRP
DH-AF-62366	£200

• Pack of 2



Cairo

CODE	RRP
DH-SF-65656	£150

• Pack of 2



Giza

CODE	RRP
DH-GZWBF	£80

• Pack of 4





WOODEN STORAGE

WORK, STORE, DIVIDE

CONTRACT 25



FIXED PEDESTALS

110

BOOKCASES & CUPBOARDS

111

UNIVERSAL PEDESTALS



FIXED

112

MOBILE

113

DESK HIGH

114

DESK SIDE STORAGE



DESK HIGH

115

UNIVERSAL STORAGE



BOOKCASES & CUPBOARDS

116



COMBO UNITS

117

UNIVERSAL STORAGE



TAMBOURS

118

UNIVERSAL STORAGE



FILING CABINETS

119

UNIVERSAL STORAGE



LOCKERS & PLANTERS

120

SYSTEMS STORAGE



TAMBOURS & CUPBOARDS

121



COMBINATION UNITS

122

SYSTEM ACCESSORIES



INTERNAL FITMENTS

123

DELUXE STORAGE



BOOKCASES & CUPBOARDS

124



COMBO UNITS

125

Contract 25 | Fixed Pedestals

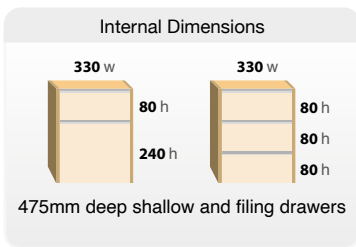

Our contract storage range offers versatile, modern storage solutions with clean lines and minimalist styling. Available in three wood finishes, Contract 25 pedestals feature silver or graphite finger pull handles and can be configured to suit any office landscape.



Lockable drawers supplied with finger pull handles in silver or graphite

Versatile under-desk storage solution to keep the work area uncluttered

Available with 3 shallow drawers or with one shallow and one filing drawer

Filing drawer designed to accept both A4 files and foolscap suspension files

2 DRAWER

CODE	HANDLES	W	D	H	RRP
CF2FP-S	Silver	416	590	474	£195
CF2FP-G	Graphite	416	590	474	£195

3 DRAWER

CODE	HANDLES	W	D	H	RRP
CF3FP-S	Silver	416	590	474	£195
CF3FP-G	Graphite	416	590	474	£195



Beech (B)



Oak (O)



White (WH)

Please add storage finish when ordering eg. **CF2FP-S** in White = **CF2FP-S-WH**



Shelf Position Guide

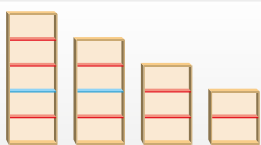

Adjustable shelves can be positioned at 64mm intervals from Fixed shelves

Our contract storage range of cupboards and bookcases in three wood finishes, offer practical organisation for any office. Shelves at 390mm deep, adjustable options, and lockable doors with curved handles, these units keep workspaces neat, tidy and match Contract 25 desks.



CFLBC

CFMCU

CFTBC

CFHCU

390mm deep shelves to easily fit all A4 ring binders and lever arch files

Available with adjustable shelves but 2 larger units have a fixed shelf central for stability

Available with adjustable shelves but 2 larger units have a fixed shelf central for stability

Can be configured to suit the requirements of any office landscape

BOOKCASES

CODE	W	D	H	SHELVES	RRP
CFLBC	756	390	830	1	£198
CFMBC	756	390	1230	2	£228
CFTBC	756	390	1630	3	£297
CFHBC	756	390	2030	4	£349

CUPBOARDS

CODE	W	D	H	SHELVES	RRP
CFLCU	756	408	830	1	£318
CFMCU	756	408	1230	2	£353
CFTCU	756	408	1630	3	£450
CFHCU	756	408	2030	4	£566



Beech (B)



Oak (O)



White (WH)

Please add storage finish when ordering eg. CFLCU in Beech = CFLCU-B

Universal Pedestals | Fixed



Internal Dimensions

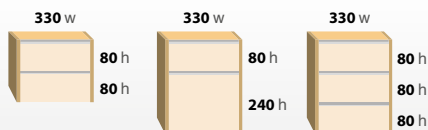

475mm deep shallow and filing drawers
425mm deep drawers on S2F

Fixed pedestals are space-saving storage solutions that attach under desks, offering secure storage for office essentials. Designed to reduce clutter and improve productivity, they fit seamlessly on the left or right side of the desk, keeping everything within reach.



S2F



R2F



R3F

Lockable drawers supplied with two keys and stylish, silver curved handles

Ideal for use with the Maestro 25 desk ranges of 600mm deep and 800mm deep desks

Available with shallow drawers or with one shallow and one filing drawer

Filing drawer designed to accept both A4 files and foolscap suspension files

600MM DEEP DESKS

CODE	Drawers	W	D	H	RRP
S2F	2 drawer	416	540	317	£170

800MM DEEP DESKS

CODE	Drawers	W	D	H	RRP
R2F	2 drawer	416	590	474	£195
R3F	3 drawer	416	590	474	£195



Beech (B)



Grey Oak (GO)



Oak (O)



Walnut (W)



White (WH)

Please add storage finish when ordering eg. R3F in Oak = R3FO



WOODEN STORAGE

Internal Dimensions

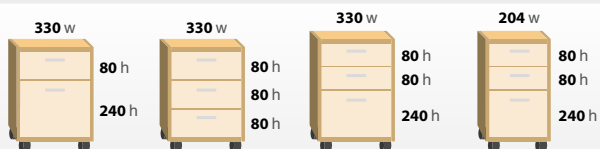

475mm deep shallow drawers & filing drawers

Mobile pedestals with easy-glide castors provide versatile under-desk storage, available in five finishes to complement any desking range. These units are practical, allowing you to keep important items securely stored and easily accessible while enhancing office efficiency.

PED-PD



R2M

R3M

TMP

TNMP

Lockable drawers supplied with finger pull handles in silver with 2 keys

Available with 3 shallow drawers or with one shallow and one filing drawer

Filing drawer designed to accept both A4 files and foolscap suspension files

Optional 50mm seat pad with set of 80kg weight loaded castors for R2M & R3M

PEDESTALS

CODE	W	D	H	RRP
R2M	426	600	567	£309
R3M	426	600	567	£309
TNMP	300	600	630	£440
TMP	426	600	630	£456

SEAT PAD

CODE	W	D	H	Band A	Band B	Band C	Band D	Band E
PED-PD	426	600	50	£182	£196	£213	£243	£269



Beech (B)



Grey Oak (GO)



Oak (O)



Walnut (W)



White (WH)

Please add storage finish when ordering eg. R2M in Grey Oak = R2MGO

Universal Pedestals | Desk High



Internal Dimensions

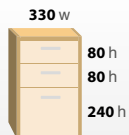

475mm deep shallow drawers & 525mm deep filing drawer (add 200mm for R25DH8)

Desk-side pedestals offer handy storage for documents, office supplies, and personal items.

Positioned next to your desk, they provide a neat and organised space, ensuring your workspace remains tidy and productive throughout the day.



R25EP8

R25DH6

R25DH8

Lockable drawers supplied with two keys and stylish, silver curved handles

600mm & 800mm deep pedestal options to fit next to straight or ergonomic desks

Available with two shallow and one filing drawer for both A4 files and foolscap suspension files

600mm deep pedestal option with a flyover top to use as a return with straight desks

PEDESTALS

CODE	W	D	H	RRP
R25DH6	426	600	725	£440
R25DH8	426	800	725	£482

DESK EXTENSION

CODE	W	D	H	RRP
R25EP8	800	600	725	£513



Beech (B)



Grey Oak (GO)



Oak (O)



Walnut (W)



White (WH)

Please add storage finish when ordering eg. R25DH6 in White = R25DH6WH



Replacement Handles



CH-K
RRP £18

CH-S
RRP £18

C2-WH
RRP £18

Suitable for all universal wooden pedestals, cupboards, combination units & filing cabinets

Our desk-side bookcases and cupboards provide a practical storage solution for files, books, and office supplies while expanding your desktop workspace. These units are ideal for keeping frequently used items close at hand without crowding your desk.



DHBC

DHCC

600mm deep desk high storage unit supplied with one adjustable shelf

25mm thick tops for increased strength with 18mm carcass and solid back panel

Cupboards with lockable doors and supplied with curved handles and two keys

Versatile desk end storage solution to keep the work area uncluttered

BOOKCASE

CODE	W	D	H	RRP
DHBC	800	600	725	£235

CUPBOARD

CODE	W	D	H	RRP
DHCC	800	600	725	£329



Beech (B)



Grey Oak (GO)



Oak (O)



Walnut (W)



White (WH)

Please add storage finish when ordering eg. DHBC in Walnut = DHBCW



Shelf Position Guide

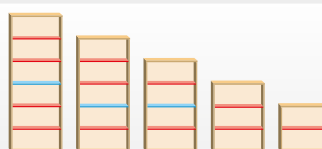

Adjustable shelves can be positioned at 64mm intervals from Fixed shelves

Stylish and minimalist, our modern cupboards and bookcases come in various wood finishes and sizes, offering practical storage that enhances the office's aesthetic. They keep the office space neat without dominating the room, providing efficient storage for any workplace.

450mm deep shelves with an 18mm carcass and 25mm thick tops

Available with adjustable shelves but 3 larger units have a fixed shelf central for stability

Cupboards with lockable doors and supplied with curved handles and two keys

Available in Duo finishes with white carcass and coloured doors in 4 finish options



R2140D

R1790

R1440D

R1090

R740D

BOOKCASES

CODE	W	D	H	Shelves	RRP
R740	800	470	740	1	£238
R1090	800	470	1090	2	£269
R1440	800	470	1440	3	£358
R1790	800	470	1790	4	£464
R2140	800	470	2140	5	£508
BS	Optional extra shelf				£77

CUPBOARDS

CODE	W	D	H	Shelves	RRP
R740D	800	470	740	1	£358
R1090D	800	470	1090	2	£400
R1440D	800	470	1440	3	£509
R1790D	800	470	1790	4	£658
R2140D	800	470	2140	5	£713
BS	Optional extra shelf				£77



Beech (B)



Grey Oak (GO)



Oak (O)



Walnut (W)



White (WH)



White/Beech (D-WHB)



White/Grey Oak (D-WHGO)



White/Oak (D-WHO)



White/Walnut (D-WHW)

Please add storage finish when ordering eg. R1090 in White = R1090WH

Universal Storage | Combination Units



WOODEN STORAGE

Shelf Position Guide



Adjustable shelves can be positioned at 64mm intervals from Fixed shelves

Combination storage units offer flexibility with a choice of open-top bookcases, glass-fronted options, and lockable cupboards. Designed to meet the diverse needs of busy offices, these units ensure that all files and essentials are stored in a safe and accessible way.

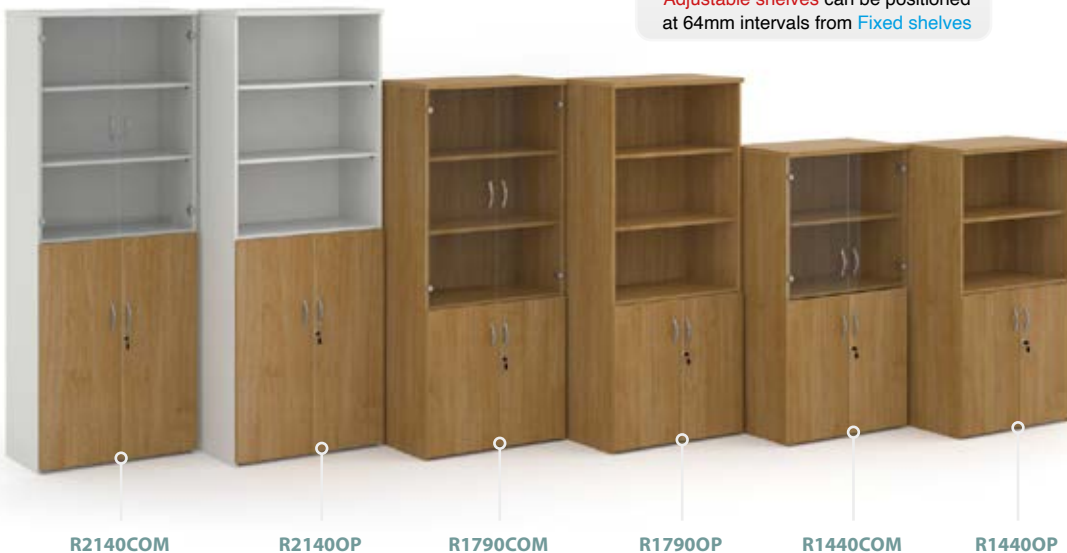

450mm deep shelves with an 18mm carcass and 25mm thick tops for stability

Available with adjustable shelves but with central shelf fixed to separate cupboards and tops

Lower cupboards with lockable doors and either open tops or glass doors with curved handles

Available in Duo finishes with white carcass and coloured doors in 4 finish options

OPEN TOP

CODE	W	D	H	Shelves	RRP
R1440OP	800	470	1440	3	£464
R1790OP	800	470	1790	4	£568
R2140OP	800	470	2140	5	£638
BS			Optional extra shelf		£77

GLASS TOP

CODE	W	D	H	Shelves	RRP
R1440COM	800	470	1440	3	£658
R1790COM	800	470	1790	4	£780
R2140COM	800	470	2140	5	£849
BS			Optional extra shelf		£77



Please add storage finish when ordering eg. R1440OP in Beech = R1440PB



Tambour door cupboards feature space-saving single doors that slide neatly into the cabinet carcass, making them ideal for maximising storage in tighter office spaces. With adjustable shelving, these units offer ample storage without obstructing walkways or office aisles.

450mm deep shelves with an 18mm carcass and 25mm thick tops for stability

Available with adjustable shelves but with central shelf fixed on the larger unit

Designed to meet the clerical needs of any busy office environment

Smooth action single tambour door with inset handle and lock for security



CODE	W	D	H	Shelves	RRP
R1090TC	800	470	1090	2	£693
R2140TC	800	470	2140	5	£966



Beech (B)



Oak (O)



White (WH)

Please add storage finish when ordering eg. R1090TC in Beech = R1090TCB

Universal Storage | Filing Cabinets



WOODEN STORAGE

Internal Dimensions



537mm deep filing drawer with 35kg drawer capacity

Sleek and functional, our filing cabinets provide a modern storage solution for office files and available in various drawer combinations. They combine stylish design with practicality, blending into any office environment while offering secure and accessible file storage.

2, 3, and 4 drawer options available built for long-term durability and security

Practical office storage solution supplied fully built with silver curved handles

Filing drawer designed to accept both A4 files and foolscap suspension files

Fully lockable drawers with ball bearing runners and anti-tilt mechanism



CODE	W	D	H	RRP
LF2*	480	655	730	£443
LF3*	480	655	1045	£489
LF4	480	655	1360	£572

*LF2 & LF3 not available in Grey Oak



Beech (B)



Grey Oak (GO)



Oak (O)



Walnut (W)



White (WH)

Please add storage finish when ordering eg. LF4 in Walnut = LF4W

Universal Storage | Lockers & Planters



Internal Dimensions

370 w 370 w

380 h

390mm deep lockers

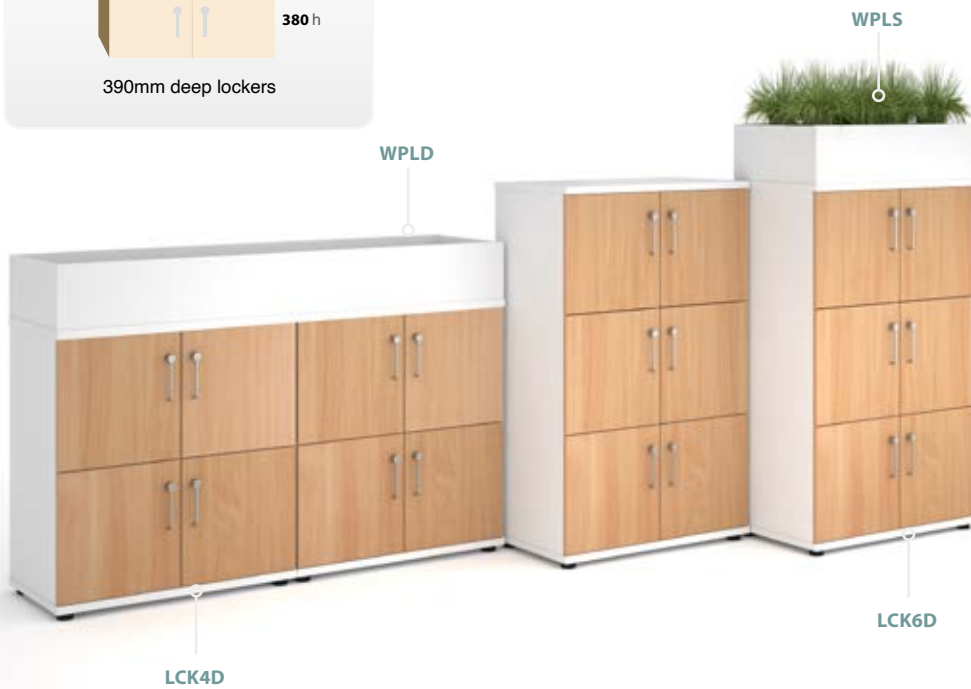

Our range of wooden door contrasting lockers offers a secure and efficient solution for storing employees' personal belongings, clothing, and other effects. Suitable for any workspace, these lockers help create a tidy, organised office environment while ensuring security.

The perfect storage solution to keep business premises functional and clutter-free

Four and six door options available with secure locks to store belongings or tech-items

Available in Duo finishes with white carcass and coloured doors in 4 finish options

Planters to fit on top of lockers for dividing the office with artificial plants or standing pots



LOCKERS

CODE	W	D	H	RRP
LCK4D	800	426	867	£566
LCK6D	800	426	1267	£785

PLANTERS

CODE	W	D	H	Finish	RRP
WPLS	800	426	200	White	£121
WPLD	1600	426	200	White	£167

PLANTS

CODE	Description	RRP
WPLS-P	Single planter insert with 8 Plants	£350
WPLD-P	Double planter insert with 16 Plants	£650



White/Beech (B)



White/Oak (O)



White/Walnut (W)



White (WH)

*Plants not included

Please add door finish when ordering eg. LCK6D with Walnut doors = LCK6DW



Our secondary systems storage, featuring cupboard or tambour doors, adapt to various workspace needs with their solid, customisable designs. Base plinth design, ideal for shelves or filing frames, these units provide flexible and secure storage solutions for the modern office.



ST20

DD16

ST12

DD8

550mm deep premium systems cupboards supplied with metal fitment brackets

25mm tops with 18mm carcass and solid back panel for added stability

Supplied empty but can be fitted with all systems extensive range of internal fitments

Sliding lockable double tambour doors supplied with two keys and inset handles

CUPBOARDS

CODE	W	D	H	RRP
DD8	1020	550	800	£680
DD12	1020	550	1200	£771
DD16	1020	550	1600	£852
DD20	1020	550	2000	£953

TAMBOURS

CODE	W	D	H	RRP
ST8	1020	550	800	£788
ST12	1020	550	1200	£915
ST16	1020	550	1600	£1079
ST20	1020	550	2000	£1209



Beech (B)



Oak (O)



White (WH)

Please add storage finish when ordering eg. ST20 in White = ST20WH

System Storage | Combination Units



This secondary systems storage range offers a perfect mix of shelved and cupboard configurations, providing the ideal space for organising office essentials. Customisable and versatile, these units enhance workspace efficiency by keeping everything within easy reach.



TG20

TO20

TG16

TO16

550mm deep premium systems cupboards supplied with metal fitment brackets

25mm tops with 18mm carcass and solid back panel for added stability

Supplied empty but can be fitted with all systems internal fitments

Sliding lockable double tambour doors supplied with two keys and inset handles

OPEN TOP

CODE	W	D	H	RRP
TO16	1020	550	1600	£979
TO20	1020	550	2000	£1085

GLASS TOP

CODE	W	D	H	RRP
TG16	1020	550	1600	£1167
TG20	1020	550	2000	£1311



Beech (B)



Oak (O)



White (WH)

Please add storage finish when ordering eg. TO20 in White = TO20WH

Shelf



CODE	W	D	H	RRP
2PS	910	390	70	£48

- Grey plain shelf for systems storage
- Practical and sturdy steel shelf

Roll Out Suspension Filing Frame



CODE	W	D	H	RRP
2RSF	880	370	90	£247

- Grey roll out suspension filing frame for systems storage
- Accepts both A4 and foolscap files

Lateral filing frame



CODE	W	D	H	RRP
2RAIL	908	390	70	£82

- Grey lateral filing frame for systems storage
- Accepts both documents and A4 suspension files



Grey



Shelf Position Guide

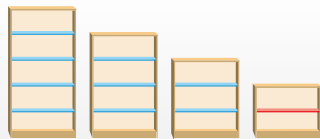

Fixed shelves shown with 382mm gap between shelves

Deluxe secondary storage furniture offers sleek, transitional design with sturdy construction. Available in four heights, these units provide functional storage while adding a touch of style to any office, ideal for dividing workspaces and solving storage issues.

550mm deep premium bookcases & cupboards with an 18mm carcass and 25mm thick tops

Supplied with fixed shelves which are deep enough to store any mix of workplace essential items

Cupboards with lockable doors and are supplied with curved handles and two keys

Deluxe bookcases and cupboards do not accept internal fitments



BOOKCASES

CODE	W	D	H	Shelves	RRP
BC8	1020	550	800	1	£419
BC12	1020	550	1200	2	£515
BC16	1020	550	1600	3	£605
BC20	1020	550	2000	4	£717

CUPBOARDS

CODE	W	D	H	Shelves	RRP
BD8	1020	550	800	1	£586
BD12	1020	550	1200	2	£715
BD16	1020	550	1600	3	£827
BD20	1020	550	2000	4	£961



Beech (B)



Oak (O)



White (WH)

Please add storage finish when ordering eg. BC12 in Beech = BC12B

Deluxe Storage | Combination Units



WOODEN STORAGE

Shelf Position Guide

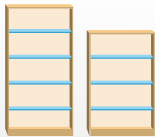

Fixed shelves shown with 382mm gap between shelves

Deluxe combination units, available in two heights, offer multiple storage options with a blend of shelves and cupboards. Designed to manage office clutter, these stylish units provide flexible and practical solutions for a more organised and efficient workspace.



550mm deep premium bookcases & cupboards with an 18mm carcass and 25mm thick tops

Supplied with fixed shelves which are deep enough to store any mix of workplace essential items

Lower cupboards with lockable doors and either open tops or glass doors with curved handles

Deluxe combination units do not accept internal fitments

OPEN TOP

CODE	W	D	H	Shelves	RRP
DO16	1020	550	1600	3	£777
DO20	1020	550	2000	4	£883

GLASS TOP

CODE	W	D	H	Shelves	RRP
DG16	1020	550	1600	3	£960
DG20	1020	550	2000	4	£1109



Beech (B)



Oak (O)



White (WH)

Please add storage finish when ordering eg. DG20 in White = DG20WH

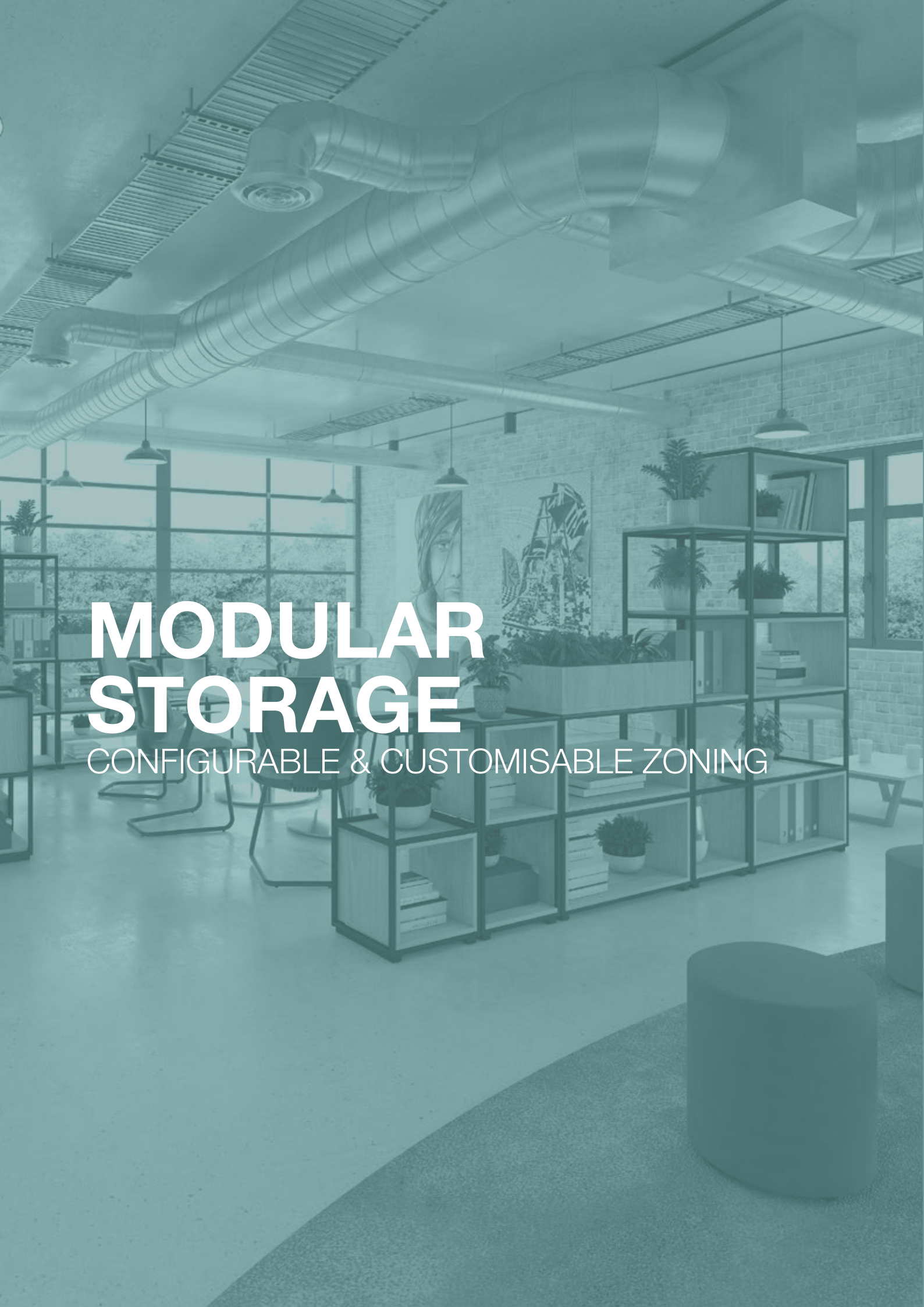

MODULAR STORAGE

CONFIGURABLE & CUSTOMISABLE ZONING

FLUX SHELVING SYSTEM



FRAMES
128

FLUX SHELVING ACCESSORIES



SHELVES
132



CUBBIES
132



PLANTER
132



PLANTS
132

FLUX MEDIA & SEATING



MEDIA
133



SEATING
133

FLUX LOCKER SYSTEM



STORAGE
134

LOCKER ACCESSORIES



RAILS
138

FLUX

MODULAR SHELVING

The Flux modular shelving system epitomises the future of adaptable, modern design. Flux has a capacitor for an infinite number of layout options and shapes to help create work zones in any space to promote privacy or transparency as needed. The crisp, clean aesthetic of the black frame allows you to break up the workplace landscape while bringing together a wide range of complementary components and products – while never compromising on design.



Frame colours



Black

Wood finishes

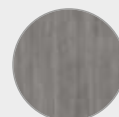

Grey Oak

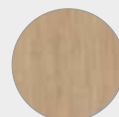

Kendal Oak



Flux | Shelving System

Single Starter Units

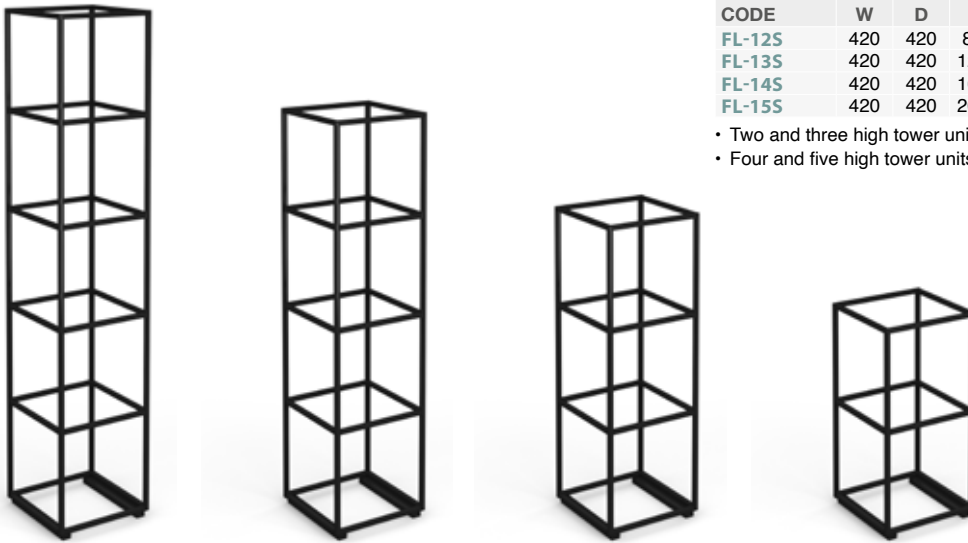

CODE	W	D	H	RRP
FL-12S	420	420	845	£392
FL-13S	420	420	1245	£497
FL-14S	420	420	1645	£613
FL-15S	420	420	2045	£698

- Two and three high tower units supplied with 1 linking bracket
- Four and five high tower units supplied with 2 linking brackets

Double Starter Units



CODE	W	D	H	RRP
FL-22D	820	420	845	£445
FL-23D	820	420	1245	£582
FL-24D	820	420	1645	£698
FL-25D	820	420	2045	£783

- Two and three high tower units supplied with 1 linking bracket
- Four and five high tower units supplied with 2 linking brackets

Linking Brackets

Brackets - How to

Each Flux configuration starts with a starter unit – which can be single or double wide and up to 5 high.

Then simply add your add-on units & accessories to suit your needs.



CODE	DESCRIPTION	W	D	H	RRP
FL-BKT-LNK	Linking bracket	380	40	5	£27

- Linking bracket to connect Flux units together
- Add additional brackets to large configurations for increased stability



*Bracket highlighted for illustration purposes only



Black Steel



Accessories

Build your frames and add your accessories to meet your personal requirements.

Please note:
Single units are also supplied for 90° corner fixings

Inner Shelves



CODE	DESCRIPTION	W	D	H	RRP
FL-IS1	Single	380	420	25	£54
FL-IS2	Double	780	420	25	£75

- Single or double shelf to sit inside black steel frame
- Add some storage and a new dimension to flux storage units

Cubbies



CODE	DESCRIPTION	W	D	H	RRP
FL-CB1	Single	380	420	380	£117
FL-CB2	Double	780	420	380	£138

- Single or double cubby unit to sit inside black steel frame
- Create the perfect storage solution or display

Planters



CODE	DESCRIPTION	W	D	H	RRP
FL-PL1	Single	420	420	195	£170
FL-PL2	Double	820	420	195	£201

- Single or double planter box to sit on black steel frame
- Featuring an area in the top for plants or standing pots

Top Shelves



CODE	DESCRIPTION	W	D	H	RRP
FL-TS1	Single	420	420	25	£65
FL-TS2	Double	820	420	25	£80
FL-TS3	Triple	1220	420	25	£91

- Single or double shelf to sit on top of black steel frame
- Ideal for storage or showing off items

Cubby Shelf



CODE	DESCRIPTION	W	D	H	RRP
FL-CS1	Single	380	420	195	£112

- Half cubby unit to sit inside black steel frame
- Tidy away messy items and accessories on stylish cubby shelves

Planters with plants



CODE	DESCRIPTION	W	D	H	RRP
FL-PLP1	Single	420	420	195	£350
FL-PLP2	Double	820	420	195	£475

- Single or double planter box complete with plants to sit on black steel frame
- Add some greenery to the workplace for a biophilic look



Grey Oak (GO) Kendal Oak (KO)

Please add finish when ordering eg. **FL-IS1** in Grey Oak = **FL-IS1-GO**

Triple Unit with Seat



Triple Unit with Media Unit

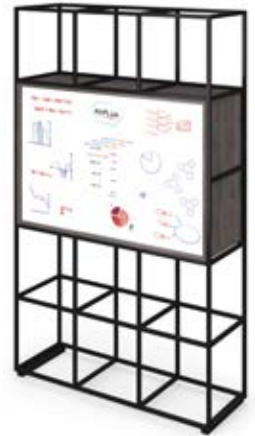

*Rear whiteboard

*Front TV bracket



CODE	W	D	H	Band A	Band B	Band C	Band D	Band E
FL-SM3	1220	420	2045	£1500	£1700	£1900	£2100	£2300

- Triple wide 5 high tower unit with central cut away
- Padded seat and sides in made to order fabric

CODE	DESCRIPTION	W	D	H	RRP
FL-MM3	Triple with media	1220	420	2045	£1650

- Triple wide 5 high tower unit with two sided media unit
- Media unit with cable management for TV & whiteboard on reverse side

Cube Seating



CODE	W	D	H	Band A	Band B	Band C	Band D	Band E
FL-SC1	380	420	380	£250	£260	£280	£300	£330

- Fully upholstered cube seat to fit inside frames
- Colourful, modern addition to enhance any workspace

Locker



CODE	DESCRIPTION	W	D	H	RRP
FL-BLD1	Single	380	420	380	£244

- Fully lockable locker unit to fit inside frame
- Keep valuables and technology safe and secure



Grey Oak (GO) Kendal Oak (KO)

Please add finish when ordering eg. **FL-BLD1** in Grey Oak = **FL-BLD1-GO**

FLUX

MODULAR LOCKERS

The Flux modular locker system offers adaptable architecture. The tower system offers flexible and secure personal storage solutions that can be used in any configurations.



Product warranty



Designed & manufactured



5 weeks lead time



Wood finishes

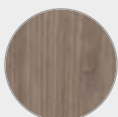

Barcelona Walnut

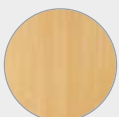

Beech

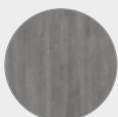

Grey Oak

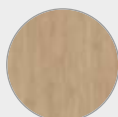

Kendal Oak



Reed Green



Onyx Grey



Misty Blue



Sand Yellow



White



Rusty Red



MODULAR STORAGE

Fux | Locker System

900mm High Locker Towers

Top and Plinth Panels - Required



FLS09-1D



FLS09-2D



CODE	W	D	H	-CL	-ML	-DL	RL
FLS09-1D	400	520	900	£375	£428	£454	£480
FLS09-2D	400	520	900	£417	£521	£573	£625

- 1 door or 2 door options available in 10 wood finish options
- 500mm deep premium systems cupboards with levelling feet

Lockers dont include top & plinth panels
Order separately based on the configuration

1300mm High Locker Towers



FLS13-1D



FLS13-2L



FLS13-2U



FLS13-3D

CODE	W	D	H	-CL	-ML	-DL	-RL
FLS13-1D	400	520	1300	£407	£459	£485	£511
FLS13-2L	400	520	1300	£448	£553	£605	£657
FLS13-2U	400	520	1300	£448	£553	£605	£657
FLS13-3D	400	520	1300	£521	£678	£756	£834

- 1 door, 2 door or 3 door options available in 10 wood finish options
- Choice of key lock, combination lock or digital locks available

Lockers dont include top & plinth panels
Order separately based on the configuration

4 week lead time



Barcelona Walnut (BW)



Beech (B)



Grey Oak (GO)



Kendal Oak (KO)



Reed Green (RG)



Onyx Grey (OG)



Misty Blue (MB)



Sand Yellow (SY)



White (WH)



Rusty Red (RR)

MTO

1700mm High Locker Towers



FLS17-1D



FLS17-2D



FLS17-2L



FLS17-2U



FLS17-3L



FLS17-3M



FLS17-3U



FLS17-4D

CODE	W	D	H	-CL	-ML	-DL	-RL
FLS17-1D	400	520	1700	£448	£500	£527	£553
FLS17-2D	400	520	1700	£495	£599	£652	£704
FLS17-2L	400	520	1700	£511	£615	£667	£719
FLS17-2U	400	520	1700	£511	£615	£667	£719
FLS17-3L	400	520	1700	£553	£709	£787	£865
FLS17-3M	400	520	1700	£553	£709	£787	£865
FLS17-3U	400	520	1700	£553	£709	£787	£865
FLS17-4D	400	520	1700	£652	£860	£964	£1068

Lockers dont include top & plinth panels
Order separately based on the configuration

- 1 door, 2 door, 3 door or 4 door options available in 10 wood finish options
- Supplied empty but can be fitted with a range of internal fitments

MODULAR STORAGE

4 week lead time

MTO

Barcelona Walnut (BW) Beech (B) Grey Oak (GO) Kendal Oak (KO) Reed Green (RG) Onyx Grey (OG) Misty Blue (MB) Sand Yellow (SY) White (WH) Rusty Red (RR)

Standard keyed cam lock



-CL

The cam latch is secured on the inside of the locker, rotating as you lock and unlock the device

- Supplied with 2 keys to close locker
- Rotate by 90 degrees clockwise to unlock and anti-clockwise to lock



Mechanical combination lock



-ML

Keyless access with a 4 wheel code combination and up to 10,000 unique combinations

- Change or reset the code easily
- Master key to retrieve forgotten codes



Digital keypad lock



-DL

10 button keypad which will perform up to 15,000 openings, without the need for keys

- Generate a unique 4 digit private code
- Rotate swivel handle for opening and closing



Digital RFID lock



-RL

A simple, smart card, radio frequency identification lock providing codeless & keyless access

- Use card supplied to swipe and open locker
- Rotate swivel handle for opening and closing



Top and Plinth Panels - Required

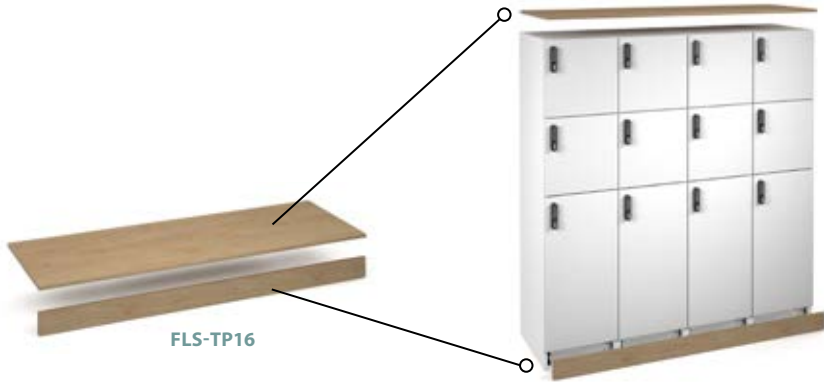

CODE	W	D	H	RRP
FLS-TP04	400	525	18	£82
FLS-TP08	800	525	18	£93
FLS-TP12	1200	525	18	£103
FLS-TP16	1600	525	18	£114

- Finishing panels for the top and base of runs of lockers for added security
- Top and plinth panels must be ordered for all locker combinations including single lockers

Example 1
4 individual lockers use 1 x 4 wide tops & plinths

Example 2
6 individual lockers use 2 x 3 wide tops & plinths

Side panels

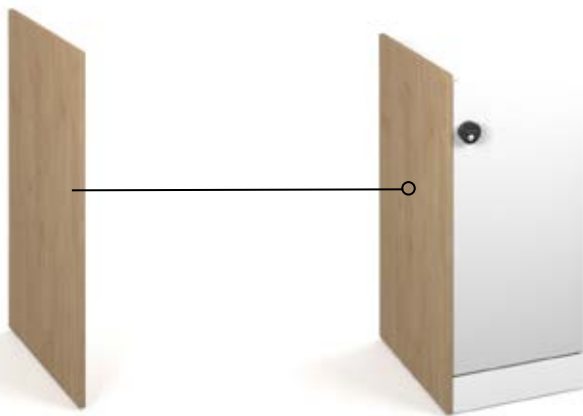

FLS-SP09

CODE	W	D	H	RRP
FLS-SP09	18	525	900	£66
FLS-SP13	18	525	1300	£76
FLS-SP17	18	525	1700	£93

- Single finishing panels available for 900mm, 1300mm & 1700mm high locker towers
- Contains fittings to attach to the sides of runs of lockers to enhance aesthetics

Accessories



FLS-WR



FLS-FCH

CODE	DESCRIPTION	RRP
FLS-WR	Internal clothes rail	£22
FLS-FCH	Folding coat hook	£39

- Hanging coat rail and folding hook to fit on the inside of 3 or 4 high locker units
- Ideal for use in cloakrooms and changing rooms to keep coats and bags safe

4 week lead time



Barcelona Walnut
(BW)



Beech
(B)



Grey Oak
(GO)



Kendal Oak
(KO)



Reed Green
(RG)



Onyx Grey
(OG)



Misty Blue
(MB)



Sand Yellow
(SY)



White
(WH)



Rusty Red
(RR)

MTO

Please add finish suffix code when ordering, followed by -SP e.g. **FLS-SP09** in Grey Oak = **FLS-SP09-GO**

A modern office interior with a stone wall, a desk with a keyboard and phone, and a large steel storage cabinet. The scene is overlaid with a semi-transparent teal filter. The storage cabinet is a large, light-colored unit with multiple drawers and open shelving. The desk in the foreground has a keyboard and a coiled telephone cord. The background shows a window and a brick wall.

STEEL STORAGE

A PLACE FOR EVERYTHING

CONTRACT



PEDESTALS
142

UNIVERSAL



PEDESTALS
144



CADIES
144



MULTI-DRAWERS
145



A4 FILERS
146

CONTRACT



FILING CABINETS
147



CUPBOARDS
152



TAMBOURS
150



FITMENTS
150

DELUXE



LODGES
153

WORKWEAR



LOCKERS
154

UNIVERSAL



LOCKERS
155









Our 3-drawer mobile steel pedestals offer versatile, secure storage with lockable drawers and an anti-tilt castor for stability. Mounted on castors for easy movement, these pedestals come in silver, white, and black, featuring deep filing capacity for office essentials.

Versatile under-desk storage solutions wide to keep the work area tidy

Two shallow drawers and one filing drawer for both A4 and foolscap files

Fully lockable drawers for secure storage of your files or personal belongings

Available static or mobile with 5th castor on drawer front for anti-tilt

-  Product warranty
-  Locking
-  Anti-Tilt
-  100% Extension
-  Suspension Filing
-  Drawer Capacity



Internal Dimensions

320 w



60 h

60 h

250 h

229 w



60 h

60 h

250 h

430mm deep shallow and filing drawers

CODE	W	D	H	RRP	CODE	W	D	H	RRP
MPN3	300	545	565	£350	MP3	391	545	565	£373

STOCKED



Black RAL9005 (K)



Silver RAL9006 (S)



White RAL9016 (WH)

Please add storage finish when ordering eg. MPN3 in Silver = MPN3-S



Product warranty



Locking



Drawer Capacity

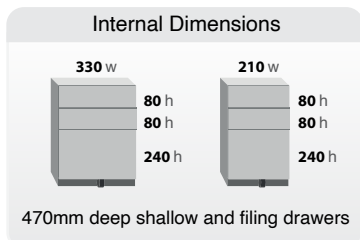

BPED-PD



MMPN

MMPW

MMPW

CODE	W	D	H	MTO
MMPN	300	565	567	£487
MMPW	420	565	567	£487

CODE	W	D	H	Band A	Band B	Band C	Band D	Band E
BPED-PD	420	565	50	£182	£196	£213	£243	£269



BISLEY

Versatile under-desk storage solutions to keep the work area uncluttered

Fully lockable with two shallow drawers and one filing drawer. Available in 2 widths

Available static or mobile with 5th castor on drawer front for anti-tilt

Fully upholstered 50mm seat pad kit option with a seat cushion on the top

5 week lead time



Black (K)



Blue (BL)



Green (GN)



Grey (G)



Orange (OR)



Red (R)



Silver (S)



White (WH)



Yellow (YE)

Please add storage finish when ordering eg. MMPN in Red = MMPN-R

Universal | Caddy Units



5

Product warranty



Locking

Internal Dimensions

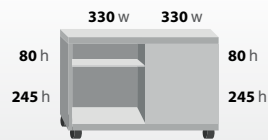

430mm deep open shelf and 390mm deep drawers

The caddy is an innovative, multifunctional mobile storage unit with two box sections, a lockable pedestal, and a shelving unit. Compact and mobile, it offers space-saving solutions with the option of a seat pad for temporary visitor seating in any workspace.



CAD800RH



CAD800LH

Versatile under-desk storage solutions to keep the work area uncluttered

Offers flexibility with rotating castors to easily position under the work surface

An attractive, functional and versatile addition to any vibrant, agile work space

Fully upholstered 50mm seat pad kit option with a seat cushion on the top

CODE	W	D	H	MTO
CAD800LH	800	440	567	£1337
CAD800RH	800	440	567	£1337

CODE	W	D	H	Band A	Band B	Band C	Band D	Band E
BCAD-PD	420	440	50	£182	£196	£213	£243	£269



BISLEY

MTO

5 week lead time



Black (K)



Blue (BL)



Green (GN)



Grey (G)



Orange (OR)



Red (R)



Silver (S)



White (WH)



Yellow (YE)

Please add storage finish when ordering eg. CAD800RH in Grey = CAD800RH-G



2

Product warranty

Internal Dimensions

235 w



50 h
50 h
50 h
50 h
50 h

370mm deep shallow drawers



B5MD

B10MD

B15MD

Multi-drawers offer excellent storage with 5, 10, or 15 drawer configurations, ideal for small offices or home workspaces. Available in various colours, these compact units can be placed on top of, under, or beside any workstation, adding both style and practicality.

Available with 5, 10 or 15 drawers in a variety of colour finish options

A sound solution for the workplace, small office or home office

Multi-compartmental insert trays for small items including paper & stationery

Chrome handle design, supplied with individual drawer label holders

CODE	W	D	H	STOCKED	MTO
B5MD	279	380	325	£192	£200
B10MD	279	380	590	£320	£343
B15MD	279	380	860	£456	£469

BISLEY

STOCKED



Grey (G)



White (WH)

5 week lead time



Black (K)



Blue (BL)



Green (GN)



Orange (OR)



Red (R)



Silver (S)



Yellow (YE)

Please add storage finish when ordering eg. B5MD in Green = B5MDGN



Product warranty



Locking



Drawer Capacity



80% Extension

Internal Dimensions

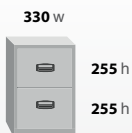

370mm deep shallow and filing drawers



BPFA2

BPFA3

The A4 home filer are available in various colours whilst, offering affordable and practical storage for home offices. Its compact exterior conceals ample filing space, making it ideal for budget-conscious users seeking efficient under-desk storage for documents and office supplies.

Functional home office storage solutions with black, centralised handles

Ideal for filing sheets of paper, folders, files and even storing personal belongings

Lockable drawers to ensure items are kept secure from those who do not have access

Drawers pull out up to 80% so you can use the space within them effectively

CODE	W	D	H	STOCKED	MTO 1	MTO 2
BPFA2	413	400	672	£240	£240	£259
BPFA3	413	400	672	£282	£282	£305

BISLEY

STOCKED



Black (K) Grey (G)

5 week lead time

MTO 1



Grey/Blue (B) Grey/Red (R)

5 week lead time







MTO 2



Blue (BL) Green (GN) Orange (OR) Red (RE) Silver (S) White (WH) Yellow (YE)

Please add storage finish when ordering eg. BPFA2 in Blue = BPFA2BL



-  Product warranty
-  Locking
-  Anti-Tilt
-  100% Extension
-  Suspension Filing
-  35 KG Drawer Capacity

Internal Dimensions



DCF2

DCF3

DCF4

Multi-drawers offer excellent storage with 5, 10, or 15 drawer configurations, ideal for small offices or home workspaces. Available in various colours, these compact units can be placed on top of, under, or beside any workstation, adding both style and practicality.

Office storage solutions for footscoop files with black, centralised handles

Fully lockable 100% extension, anti-tilt drawers supplied with two keys

Fully welded carcass with high sided easy glide drawers. Available in three heights

Approved to British Standards BSEN 14073 parts 2&3 and BSEN 14074

CODE	W	D	H	STOCKED	MTO
DCF2	470	622	711	£368	£404
DCF3	470	622	1016	£422	£463
DCF4	470	622	1321	£464	£513

STOCKED



Black (K) Grey (G) White (WH)

5 week lead time

MTO



Blue (BL) Coffee / Cream (C) Green (GN) Orange (OR) Red (R) Silver (S) Yellow (YE)

Please add storage finish when ordering eg. DCF2 in Yellow = DCF2YE



Executive filing cabinets maximise office space with fully extendable drawers and lockable security. Designed for both document storage and workspace division, these robust units are ideal for creating organised, efficient office environments.

Office storage solutions for foolscap files with full length finger pull handles

Fully lockable 100% extension, anti-tilt drawers, supplied with two keys

Fully welded carcass with no bolts or rivets for greater strength

Approved to British Standards BSEN 14073 parts 2&3 and BSEN 14074

8

Product warranty



Locking



Anti-Tilt



100% Extension



Suspension Filing



35 KG Drawer Capacity

Internal Dimensions

385 w



260 h

260 h

540mm deep filing drawers



DEF2

DEF3

DEF4

CODE	W	D	H	STOCKED	MTO 1	MTO 2
DEF2	470	622	711	£394	£414	£435
DEF3	470	622	1016	£448	£471	£487
DEF4	470	622	1321	£487	£513	£539

BISLEY

STOCKED



Black (K)

Grey (G)

5 week lead time



Coffee / Cream (C)

Silver (S)

White (WH)

Please add storage finish when ordering eg. DEF2 in Black = DEF2K

5 week lead time



Blue (BL)

Green (GN)

Orange (OR)

Red (R)

Yellow (YE)

Deluxe | Filing Cabinets



STEEL STORAGE

10

Product warranty



Locking



Anti-Tilt



100% Extension



Suspension Filing



Drawer Capacity

Internal Dimensions

385 w



260 h

260 h

540mm deep filing drawers



BPSF2

BPSF3

BPSF4

Combining market-driven design with high-quality UK manufacturing, steel public sector filing cabinets are durable and secure. These lockable units ensure secure storage and support GDPR compliance, making them ideal for public sector tenders.

Functional office storage solutions for foolscap files with finger pull handles

Fully lockable 100% extension, anti-tilt drawers supplied with two keys

Fully welded carcass with high sided drawers and 40kg load capacity

Approved to British Standards BSEN 14073 parts 2&3 and BSEN 14074

CODE	W	D	H	MTO 1	MTO 2
BPSF2	470	622	711	£445	£470
BPSF3	470	622	1016	£493	£522
BPSF4	470	622	1321	£556	£588

BISLEY

5 week lead time



Black (K)



Coffee / Cream (C)



Grey (G)



Silver (S)



White (WH)

5 week lead time



Blue (BL)



Green (GN)



Orange (OR)



Red (R)



Yellow (YE)

Please add storage finish when ordering eg. BPSF2 in Orange = BPSF2OR

System Storage | Tambours



Product warranty



Locking



Takes Internals

Systems storage cupboards with aluminium tambour doors offer secure, space-saving solutions. The doors retract smoothly into the unit, leaving office walkways clear, and the cupboards are supplied fully assembled to meet all your filing needs.

470mm deep cupboard with tambour doors supplied with no shelves

Sliding double tambour design saves space with fully lockable doors

Can be fitted with all systems internal fittings for an advanced storage solution

Approved to British Standards BSEN 14073 parts 2&3 and BSEN 14074



CODE	W	D	H	STOCKED	MTO 1	MTO 2
DST40	1000	470	1000	£787	£891	£906
DST65	1000	470	1570	£870	£968	£984
DST78	1000	470	1970	£942	£1015	£1035

BISLEY

STOCKED



Black (K)



Grey (G)



Silver (S)



White (WH)

5 week lead time



Silver/Beech (SB)

5 week lead time



Blue (BL)



Green (GN)



Orange (OR)



Red (R)



Yellow (YE)

MTO 2

Please add storage finish when ordering eg. DST40 in Silver/Beech = DST40SB

System Access | Internal Fitments

Shelf



CODE	DESCRIPTION	RRP
DSTS	Shelf	£40

- Black plain shelf for systems storage
- Practical and sturdy steel shelf

Roll Out Filing Frame

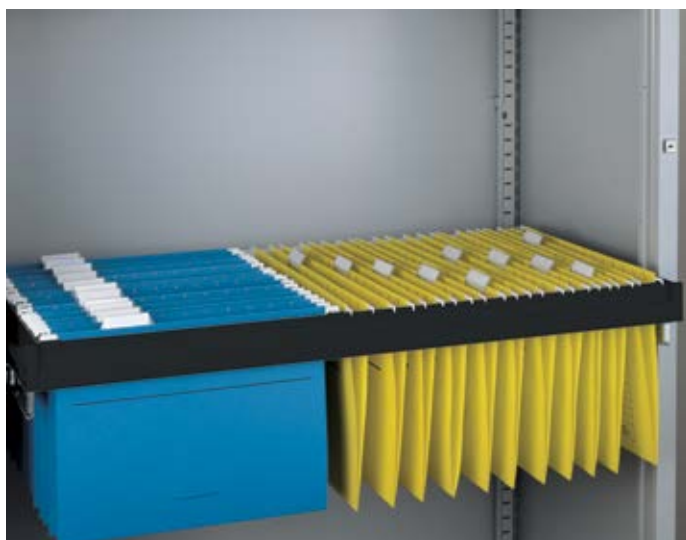

CODE	DESCRIPTION	RRP
BROSF	Roll out filing frame	£254

- Black roll out suspension filing frame for systems storage
- Accepts both A4 and foolscap files

Lateral Filing Frame



CODE	DESCRIPTION	RRP
BUR	Lateral filing frame	£81

- Black lateral filing frame for systems storage
- Accepts both documents and A4 suspension files

- Black lateral filing frame for systems storage
- Accepts both documents and A4 suspension files

STEEL STORAGE



Black

Contract | Cupboards



Product warranty



Locking



Shelf Capacity



Supplied with Shelves



DSC40

DSC72

DSC78

CODE	W	D	H	Shelves	STOCKED	MTO 1	MTO 2
DSC40	914	400	1000	1	£464	£492	£518
DSC72	914	400	1806	3	£565	£587	£634
DSC78	914	400	1968	4	£725	£751	£797
BCSLF	Optional extra shelf (Black)				£69		

Contract double-door cupboards provide maximum storage in a compact design. With height-adjustable shelves and a three-point locking system, these cupboards with fully welded carcasses offer strength, stability, and security in any busy office setting.

400mm deep cupboards supplied with adjustable shelves. Available in three heights

High quality, stylish and robust for demanding work environments

Fully welded carcass supplied pre-assembled with fully lockable double doors

Approved to British Standards BSEN 14073 parts 2&3 and BSEN 14074

STOCKED



Black (K) Grey (G) White (WH)

MTO 1

5 week lead time



Coffee / Cream (C) Silver (S)

MTO 2

5 week lead time



Blue (BL) Green (GN) Orange (OR) Red (R) Yellow (YE)

Please add storage finish when ordering eg. DSC40 in Coffee/Cream = DSC40C



Product warranty



Locking



BLFL4D

BLFL6D

Our lodges with letter boxes are ideal for offices and shared spaces, offering secure compartments for personal belongings and internal mail distribution. Available with 4 or 6 doors, these units streamline the management of internal mail and personal items.

Lodges come in two heights with matching drawer unit dimensions

Four and six door options available, great for university or shared housing

Post can go through the slot, but only the owner can get it out with their key

Safe & secure storage of personal belongings and internal mail

Internal Dimensions

370 w 370 w



440mm deep lockers

CODE	W	D	H	Doors	MTO
BLFL4D	800	470	845	4	£1553
BLFL6D	800	470	1225	6	£2070

BISLEY

MTO

5 week lead time



Silver (S)

White (WH)

Please add storage finish when ordering eg. BLFL4D in Silver = BLFL4DS



5

Product warranty

Internal Dimensions

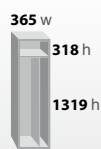

578mm deep locker



WKCL181

WKPL181

WKCD181

CODE	Description	W	D	H	STOCKED	MTO
WKCL181	Workwear combi locker	450	450	1800	£492	£492
WKPL181	Police locker	450	600	1800	£492	£492
WKCD181	Clean & dirty locker	450	600	1800	£508	£508

Steel workwear lockers are built for durability and organised storage of uniforms, PPE, and work equipment. Available in various door colours, they are designed to withstand heavy use, offering secure storage for workwear in demanding environments. Available in three colours.

Supplied with a key lock as a secure option for workwear and personal belongings

Single door police locker with 2 compartments to store headwear and a coat rail for uniform

Clean and dirty locker perfect for separating clean clothes from dirty workwear and overalls

Combi locker features a coat hook with internal shelves to store personal and workwear items

BISLEY

STOCKED

MTO



Grey (G)

5 week lead time



Blue (B)



Red (R)

Please add storage finish when ordering eg. WKCD181 in Red = WKCD181R



Product warranty



Locking

Internal Dimensions

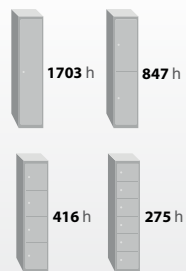

240mm wide lockers
274mm deep or 426mm deep



CLK121

CLK122

CLK184

CLK186

CODE	W	D	H	Doors	STOCKED	MTO	CODE	W	D	H	Doors	STOCKED	MTO
CLK121	305	305	1802	1	£290	£290	CLK181	305	457	1802	1	£335	£335
CLK122	305	305	1802	2	£363	£363	CLK182	305	457	1802	2	£402	£402
CLK124	305	305	1802	4	£425	£425	CLK184	305	457	1802	4	£464	£464
CLK126	305	305	1802	6	£508	£508	CLK186	305	457	1802	6	£551	£551

Universal lockers provide personal storage for staff rooms, cloakrooms, and production facilities. Available in multiple sizes and configurations, these lockers can be bolted together to create custom layouts, offering streamlined storage options. Available in two colours.

Fitted with a camlock with 1,000 different master lock combinations

Lockers bolt together at the back and side with ventilation holes in lockers

Single door and two door lockers feature under shelf coat storage

Approved to British Standards BSEN 14073 parts 2&3, BSEN 14074, BS4875 1998 part 7 (level 4)

BISLEY

STOCKED



Grey (G)

MTO



Blue (B)

5 week lead time

Please add storage finish when ordering eg. CLK121 in Grey = CLK121G



SCREENS

DESKTOP, FLOOR STANDING
& PRIVATE WORKING

DESKTOP FABRIC



STRAIGHT
158



WAVE
159



VIBE
160

DESKTOP ALUMINIUM



FABRIC
162



GLAZED
163

DESKTOP BRACKETS



FITTINGS
166

FLOOR STANDING SCREENS



PRIVA
161



STRAIGHT FLOOR STANDING
164



FLOOR STANDING ACCESSORIES
165

Straight | Desktop Fabric Wrapped



Our fabric straight desktop screens provide an economical solution for dividing desk clusters, ensuring employee privacy and comfort. Supplied with brackets for 25mm desktops, they also offer a universal bracket option for various desk types. Finished height is 400mm above desk.



30mm thick with a layer of foam between outer fabric and MFC core

Combines a slim fabric wrapped profile with a robust and durable construction

Desk mounted screens use standard desk brackets which come as standard

When using as a return screen order ESRB (see page 166)



CODE	W	D	H	STOCKED	Band A	Band B	Band C	Band D	Band E
ES800S	800	30	400	£155	£171	£186	£217	£233	£252
ES1000S	1000	30	400	£171	£186	£201	£232	£250	£271
ES1200S	1200	30	400	£180	£196	£213	£245	£264	£285
ES1400S	1400	30	400	£200	£216	£230	£261	£281	£304
ES1600S	1600	30	400	£210	£223	£238	£271	£291	£315
ES1800S	1800	30	400	£217	£230	£248	£276	£297	£321

STOCKED



Blue (B)



Black (K)

3-4 week lead time

MTO



Supplied with standard brackets for straight desks only. For additional brackets see Page 166

Please add fabric colour finish when ordering eg. ES1600S in Charcoal = ES1600S-C

Wave | Desktop Fabric Wrapped



SCREENS

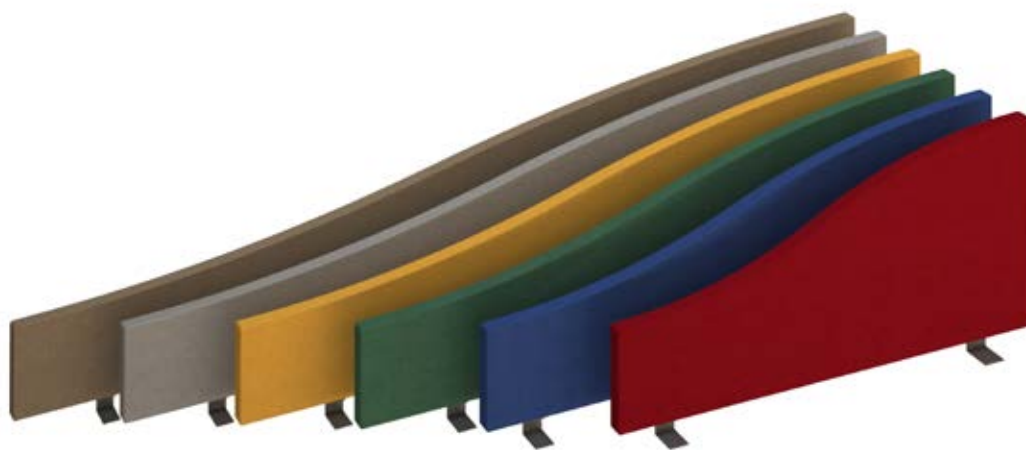

Designed for desktops, fabric wave screens enhance employee privacy, elevating comfort while they work. These screens come with brackets for 25mm desktops, and offer an optional universal bracket for compatibility with other manufacturers. Wave height is 200 to 400mm above desk.

30mm thick with a layer of foam between outer fabric and MFC core

Combines a slim fabric wrapped profile with a robust and durable construction

Desk mounted screens use standard desk brackets which come as standard

When using as a return screen order ESRB (see page 166)



CODE	W	D	H	STOCKED	Band A	Band B	Band C	Band D	Band E
ES800W	800	30	200-400	£164	£179	£194	£224	£242	£261
ES1000W	1000	30	200-400	£180	£196	£213	£245	£264	£285
ES1200W	1200	30	200-400	£200	£216	£230	£261	£281	£304
ES1400W	1400	30	200-400	£210	£223	£238	£271	£291	£315
ES1600W	1600	30	200-400	£217	£230	£248	£276	£297	£321
ES1800W	1800	30	200-400	£224	£238	£254	£285	£307	£332

STOCKED



Blue (B)



Black (K)

3-4 week lead time

MTO 1



Supplied with standard brackets for straight desks only. For additional brackets see page 166

Please add fabric colour finish when ordering eg. ES1600W in Charcoal = ES1600W-C

Vibe | Desktop Fabric Wrapped



Vibe contemporary screens are made to order and available in a variety of fabric colours. With a slim profile and robust construction, they are ideal for bench desking and come with standard universal brackets for easy installation. Finished height is 400mm above desk.



35mm thick with an additional foam layer between outer fabric and MFC core

Made to order, designer desktop screens which are elegant, modern and stylish

Hand crafted, exposing the edge of the stitch detail on a radius corner

Versatile office desk partitions to help provide physical and acoustic barriers

CODE	W	D	H	Band A	Band B	Band C	Band D	Band E
VB800	800	35	400	£190	£201	£232	£250	£271
VB1000	1000	35	400	£201	£219	£250	£270	£290
VB1200	1200	35	400	£216	£230	£261	£281	£304
VB1400	1400	35	400	£231	£249	£278	£299	£324
VB1600	1600	35	400	£242	£256	£287	£309	£334
VB1800	1800	35	400	£249	£265	£295	£318	£344



MTO

3-4 week lead time



Supplied with standard brackets for straight desks only. For additional brackets see page 166



Priva modular floor screens are designed to be used in dynamic groups as well as repeated in rows of screens. Whether it's a touchdown area, collaborative space, personal workstation or a private office, Priva surround screens make it easy to create unique, inspiring and functional spaces.

Aid concentration, reduce noise pollution and even prevent sickness from spreading

A cost effective solution to maximising space in the office and wider workplace

3 screen systems ideal for a semi-private meeting space, photocopying area or drinks section

Clean modern designs that are easy to assemble and reconfigure when needed

CODE	DESCRIPTION	W	D	H	Band A	Band B	Band C	Band D	Band E
PRV-SQ01	C-shape	2630	2800	1500	N/A	N/A	N/A	£6866	£7077
PRV-SQ02	S-shape	2630	5200	1500	N/A	N/A	N/A	£10298	£10510
PRV-HX01	Half hexagon	3490	2270	1500	N/A	N/A	N/A	£6866	£7077



MTO

5 week lead time



Straight | Aluminium Frame



Aluminium frame screens offer privacy for desks in close proximity. Available in silver, white, and black, these frames include matching brackets for easy installation, with fabric options in blue and custom choices available, to suit any modern workspace. Finished height is 400mm above desk.

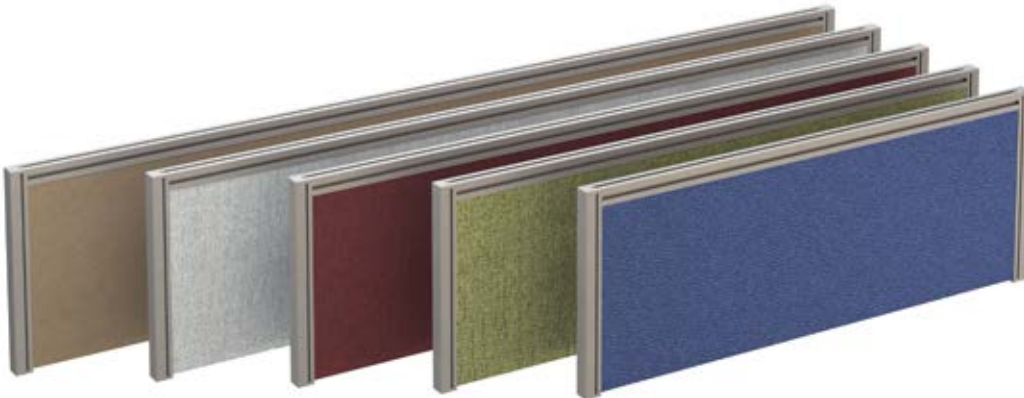

30mm thick with robust aluminium frames for additional stability

Fully upholstered fabric screens that offer a level of increased privacy

Available for all size desks with additional screen size for the desk returns

Desk brackets available in black, silver and white to match screen frames

CODE	W	D	H	STOCKED	Band A	Band B	Band C	Band D	Band E
A785*	785	30	380	n/a	£205	£235	£280	£302	£327
A1000	1000	30	380	n/a	£219	£280	£309	£333	£360
A1200	1200	30	380	£232	£234	£298	£321	£345	£373
A1400	1400	30	380	£248	£250	£302	£344	£371	£401
A1600	1600	30	380	£283	£285	£331	£372	£401	£434
A1800	1800	30	380	£302	£306	£353	£389	£420	£453



* A785 suitable for 800mm return desks

FRAME COLOURS

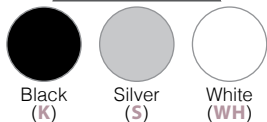

STOCKED



MTO

3-4 week lead time



Supplied without brackets. See Page 166 for brackets to be ordered separately

Please add frame colour followed by fabric colour when ordering eg. A1600 with Silver frame in Blue = A1600-S-B



Aluminium frame screens feature stylish semi-transparent glazed panels that enhance privacy while allowing light to flow through the room. Available in silver, white, or black, they effectively reduce ambient noise in shared spaces, and provide employees with additional privacy.



30mm thick with robust aluminium frames for additional stability

Glazed semi-transparent perspex screens that offer a level of increased privacy

Ideal for use on bench desks with additional brackets available for runs of desks

Desk brackets available in black, silver and white to match screen frames

CODE	W	D	H	STOCKED
AG1000	1000	30	380	£273
AG1200	1200	30	380	£298
AG1400	1400	30	380	£315
AG1600	1600	30	380	£346
AG1800	1800	30	380	£389



FRAME COLOURS

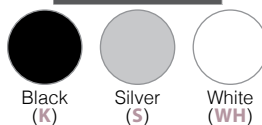

STOCKED



Supplied without brackets. See Page 166 for brackets to be ordered separately

Please add frame colour followed by glaze colour when ordering eg. AG1600 with Silver frame in White = AG1600-S-W

Straight | Floor Standing Fabric Wrapped



Free-standing floor screens are offered in three heights to visually divide open-plan spaces without sacrificing the benefits of an open-plan layout. Fabric-wrapped floor screens also provide crucial seclusion, and can be joined with linking strips to connect multiple screens.

40mm thick with an additional foam layer between outer fabric and MFC core

Available in numerous widths and three heights of 1200mm, 1500mm a& 1800mm

Screens can utilise the desk as support or can be used with bar feet supplied

2 panel linking strips for connecting screens together (see next page)

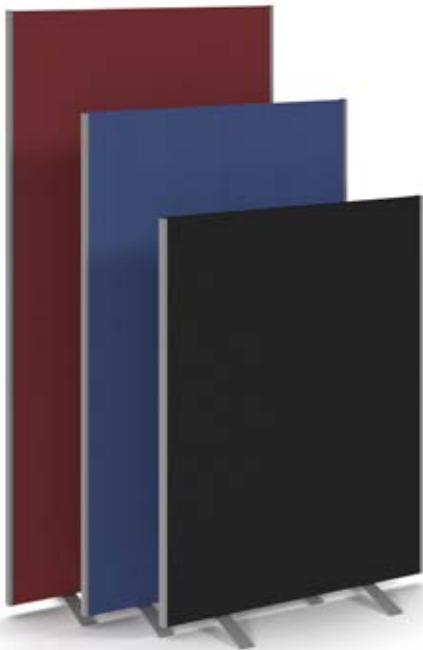

CODE	W	D	H	STOCKED	Band A	Band B	Band C
208	800	40	1200	n/a	£245	£275	£325
210	1000	40	1200	n/a	£245	£275	£325
212	1200	40	1200	n/a	£259	£289	£340
214	1400	40	1200	n/a	£259	£289	£340
216	1600	40	1200	n/a	£276	£308	£372
218	1800	40	1200	n/a	£294	£327	£387

CODE	W	D	H	STOCKED	Band A	Band B	Band C
508	800	40	1500	n/a	£248	£278	£325
510	1000	40	1500	n/a	£262	£294	£340
512	1200	40	1500	£285	£294	£327	£387
514	1400	40	1500	n/a	£305	£337	£397
516	1600	40	1500	£301	£321	£350	£417
518	1800	40	1500	£331	£342	£374	£433

CODE	W	D	H	STOCKED	Band A	Band B	Band C
808	800	40	1800	n/a	£294	£327	£387
810	1000	40	1800	n/a	£294	£327	£387
812	1200	40	1800	£331	£342	£374	£433
814	1400	40	1800	£331	£342	£374	£433
816	1600	40	1800	£346	£349	£383	£441

STOCKED



Blue (B)



Black (K)

3 week lead time

MTO



Please add fabric colour finish when ordering eg. 816 in Blue = 816-B

Accessories | Feet & Linking

Designer Screen Feet



CODE	Description	RRP
VFT1	Screen feet (pair)	£90

- For use with floor standing screens
- Designer screen feet for floor standing screens

Floor Screen Linking Strips

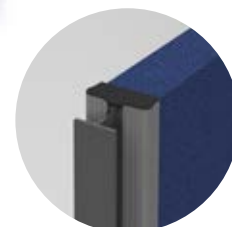

CODE	Description	RRP
LK22	1200mm 2-2 Strip	£23
LK25	1500mm 2-2 Strip	£24
LK28	1800mm 2-2 Strip	£25

- Links floor standing fabric screens
- For connecting 2 screens together

Floor Screen Linking Strips

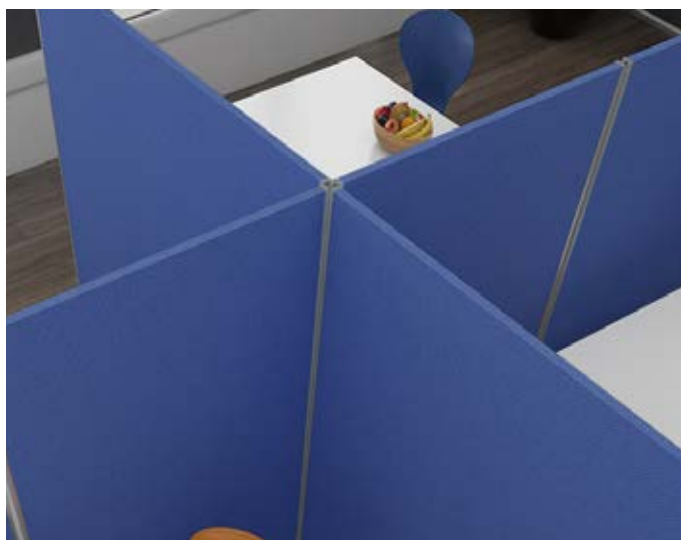

CODE	Description	RRP
LK42	1200mm 4-4 Strip	£33
LK45	1500mm 4-4 Strip	£37
LK48	1800mm 4-4 Strip	£40

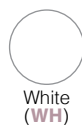

Please add foot colour when ordering eg. **VFT1** in Silver = **VFT1-SL**

Universal | Desktop Brackets & Linking

Universal Desktop Screen Brackets

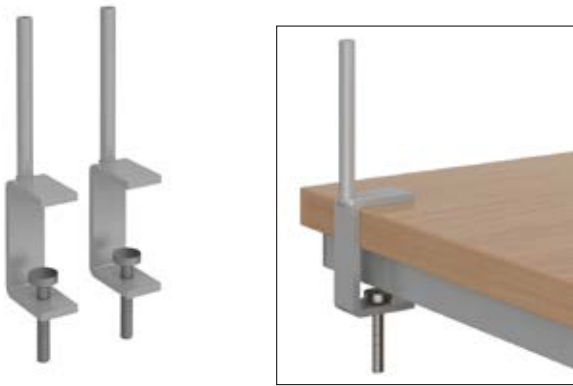

CODE	Description	RRP
UNSCBR	Universal bracket (pair)	£35

- Clamps between 15mm-50mm desktops
- For use on all non-aluminium fabric desk screens

Desk Return Brackets

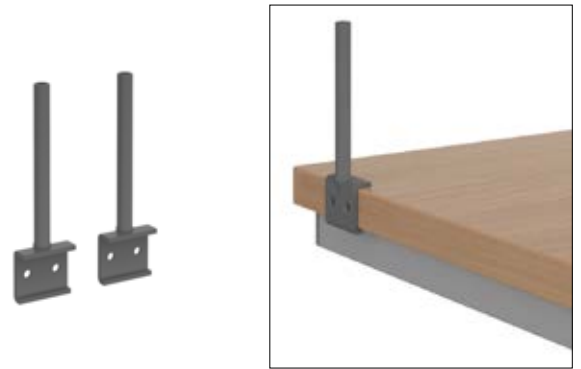

CODE	Description	RRP
ESRB	Return bracket (pair)	£33

- Used to attach desks to return sides of desks, graphite only
- For use on all non-aluminium fabric desk screens

Aluminium Frame Fabric Screen Brackets



CODE	Description	RRP
AFSBK	For fabric screens	£59

- Clamps to standard desktops
- Used on single desks or runs of single desks

Aluminium Frame Glazed Screen Brackets



CODE	Description	RRP
AGSBK	For glazed screens	£72

- Clamps to standard desktops
- Used on single desks or runs of single desks

Adapt & Fuze Back-To-Back Desk Brackets



CODE	Description	RRP
EDELSB	End bracket	£43

- Bolts directly to under frame of desk
- Used on Adapt and Fuze bench desks

Adapt & Fuze Back-To-Back Desk Brackets

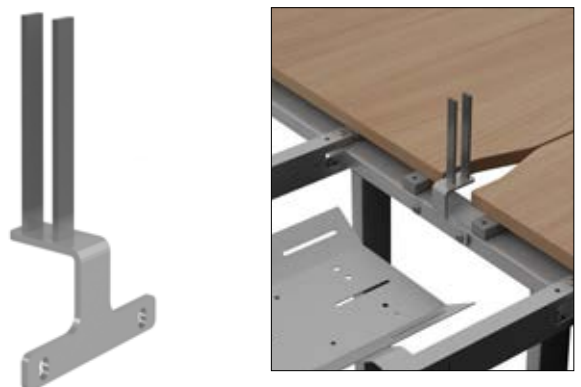

CODE	Description	RRP
EDILSB	Intermediate bracket	£50

- Bolts directly to under frame of desk
- Used on Adapt and Fuze bench desks

BRACKET COLOURS



Black (K)



Silver (S)



White (WH)

Please add finish when ordering eg. **AFSBK** in silver = **AFSBK-S**

Universal | Desktop Brackets & Linking

Aluminium Frame Screen Brackets



CODE	Description	RRP
ARBK	For the back of desks, pack of 2	£68

- Screw clamps to fit all desks
- Fix to the back of desks

Aluminium Frame Screen Return Brackets

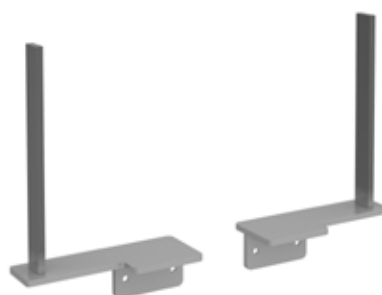

CODE	Description	RRP
ASBK	For desk return, pack of 2	£68

- Screw clamps to fit all desks
- Fix to the back of desks

Aluminium Frame Return Screen Brackets for Mid Runs



SA-LINK-KIT



SBKT50

CODE	Description	RRP
SBKT50	Screen mid run brackets	£36
SA-LINK-KIT	Screen linking kit	£36

- SBKT50 - Front mounting screen bracket
- SA-LINK-KIT - Rear mounting screen connector to rear desktop screens

BRACKET COLOURS



Black (K)



Silver (S)



White (WH)

Please add finish when ordering eg. **ASBK** in silver = **ASBK-S** (**SBKT50** and **SA-LINK-KIT** available in silver only)

Fabrics | Compatibility / Range

Product	Rear Screens							Return Screens			
	Vibe Elev8 ² Single (1000/1200/1400/1600)	Vibe Elev8 ² B2B (1200/1400/1600)	Vibe Desktop (800/1000/1200/1400/1600/1800)	Aluminium Fabric (800/1000/1200/1400/1600/1800)	Aluminium Glazed (800/1000/1200/1400/1600/1800)	Fabric Straight (800/1000/1200/1400/1600/1800)	Fabric Wave (800/1000/1200/1400/1600/1800)	Aluminium Fabric (785)	Aluminium Glazed (785)	Fabric Straight (800/1000/1200)	Fabric Wave (800/1000/1200)
Elev8² Single desks	✓ Bracket SUPPLIED		✓ Bracket SUPPLIED	✓ Order ARBK	✓ Order ARBK	✓ Bracket SUPPLIED	✓ Bracket SUPPLIED	✓ Order ASBK	✓ Order ASBK	✓ Order ESRB	✓ Order ESRB
Elev8² Back-to-back desks		✓ Bracket SUPPLIED									
Adapt II Single desks	✓ Bracket SUPPLIED		✓ Bracket SUPPLIED	✓ Order AFSBK	✓ Order AGSBK	✓ Bracket SUPPLIED	✓ Bracket SUPPLIED	✓ Order ASBK	✓ Order ASBK	✓ Order ESRB	✓ Order ESRB
Adapt II Back-to-back desks			✓ Bracket SUPPLIED	✓ Bracket EDELSB/ EDILSB	✓ Bracket EDELSB/ EDILSB	✓ Bracket SUPPLIED	✓ Bracket SUPPLIED	✓*∞ Order ASBK	✓*∞ Order ASBK		
Fuze Single desks	✓ Bracket SUPPLIED		✓ Bracket SUPPLIED	✓ Order AFSBK	✓ Order AGSBK	✓ Bracket SUPPLIED	✓ Bracket SUPPLIED	✓ Order ASBK	✓ Order ASBK	✓ Order ESRB	✓ Order ESRB
Fuze Back-to-back desks			✓ Bracket SUPPLIED	✓ Bracket EDELSB/ EDILSB	✓ Bracket EDELSB/ EDILSB	✓ Bracket SUPPLIED	✓ Bracket SUPPLIED	✓* Order ASBK	✓* Order ASBK		
Connex II Single desks	✓ Bracket SUPPLIED		✓ Bracket SUPPLIED	✓ Order ARBK	✓ Order ARBK	✓ Bracket SUPPLIED	✓ Bracket SUPPLIED	✓* Order ASBK	✓* Order ASBK		
Connex II Back-to-back desks			✓ Bracket SUPPLIED	✓ Order ARBK	✓ Order ARBK	✓ Bracket SUPPLIED	✓ Bracket SUPPLIED	✓* Order ASBK	✓* Order ASBK		
TR10 Desks	✓ Bracket SUPPLIED		✓ Bracket SUPPLIED	✓ Order ARBK	✓ Order ARBK	✓ Bracket SUPPLIED	✓ Bracket SUPPLIED	✓† Order ASBK	✓† Order ASBK	✓† Order ESRB	✓† Order ESRB
Vivo Desks			✓ Bracket SUPPLIED	✓ Order ARBK	✓ Order ARBK	✓ Bracket SUPPLIED	✓ Bracket SUPPLIED	✓† Order ASBK	✓† Order ASBK	✓† Order ESRB	✓† Order ESRB
Maestro 25 Desks			✓ Bracket SUPPLIED	✓ Order ARBK	✓ Order ARBK	✓ Bracket SUPPLIED	✓ Bracket SUPPLIED	✓† Order ASBK	✓† Order ASBK	✓† Order ESRB	✓† Order ESRB
Contract 25 Desks			✓ Bracket SUPPLIED	✓ Order ARBK	✓ Order ARBK	✓ Bracket SUPPLIED	✓ Bracket SUPPLIED	✓ Order ASBK	✓ Order ASBK	✓ Order ESRB	✓ Order ESRB

* For return screen mid-runs use SBKT50 and SA-LINK-KIT

✓ Recommended screen

∞ Return screens not suitable for back-to-back desks with sliding tops

✓ Compatible screen

† Return screens not suitable for 600mm straight desks

Fabrics | Compatibility / Range

Fabrics specified for their acoustic properties are ideal for wall coverings, suspended ceiling panels, desk mounted or free standing screens. The job of the fabric is to allow sound to pass through cleanly, or provide a degree of absorbency, which allows the specialist acoustic system behind to do what it needs to do.

Stocked

Supplier **Range**
Macflex Mac182

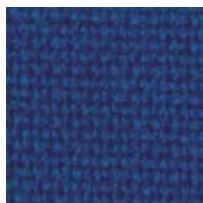

BLUE (B)

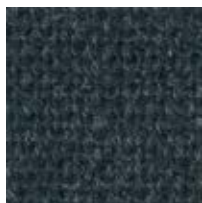

BLACK (K)

Made to order

Band	Supplier	Range
A	Camira	Cara Carlow Fiji
B	Camira Inloom	Era 170 Bondai 170
C	Camira	Sonus Lucia
D	Camira	Blazer Lite Nexus
E	Camira	Synergy 170

Camira Cara Band A



EJ186 FAIR ISLE

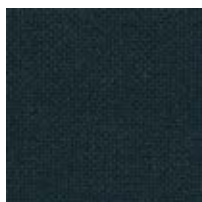

EJ138 BLACK



EJ190 HILLSWICK

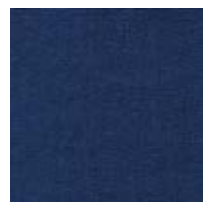

EJ180 CLUANIE



EJ076 PITLOCHRY

Inloom Bondai 170 Band B



4711

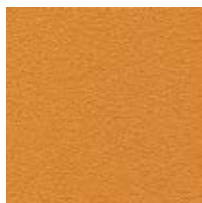

3705



6771

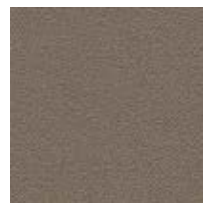

1708



8778

Camira Lucia Band C



YB097 BLUEBELL



YB156 MADURA



YB093 ARUBA



YB106 CALYPSO

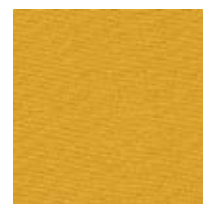

YB088 SOLANO

Camira Blazer Lite Band D

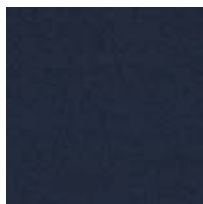

LTH44 MOOD



LTH64 DAINITY

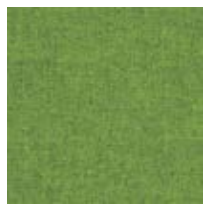

LTH55 HAPPY

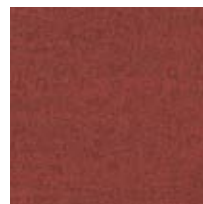

LTH52 ASPIRE



LTH39 RETREAT

Camira Synergy 170 Band E



LDP54 REGARD



LDP56 KINSHIP

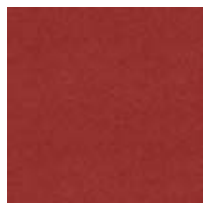

LDP85 SHARE

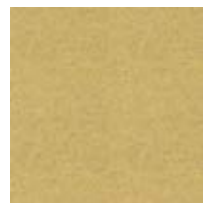

LDP45 SUMMON



LDP20 LEVEL

SCREENS



PIANO ACOUSTICS

SOUND MANAGEMENT

ACOUSTIC DESKTOP



FORTE
172

ACOUSTICS WALL TILES



SQUARE
173



RECTANGLE
173



TRIANGLE
173



HEXAGON
173

ACOUSTIC PANELS



CHORDS
174

ACOUSTIC CEILING



SCALES
175

ACOUSTIC BOOTH



SOLO
176

ACOUSTIC FLOOR STANDING

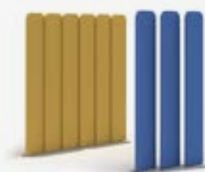

KEYS
177

Forte | Desktop Screen



Slide-on desk dividing screens in orange or silver grey acoustic PET help to define boundaries and reduce the spread of airborne diseases. They clip onto desktops, creating personal distance without needing to reconfigure spaces. The pitched shape creates a dynamic aesthetic.

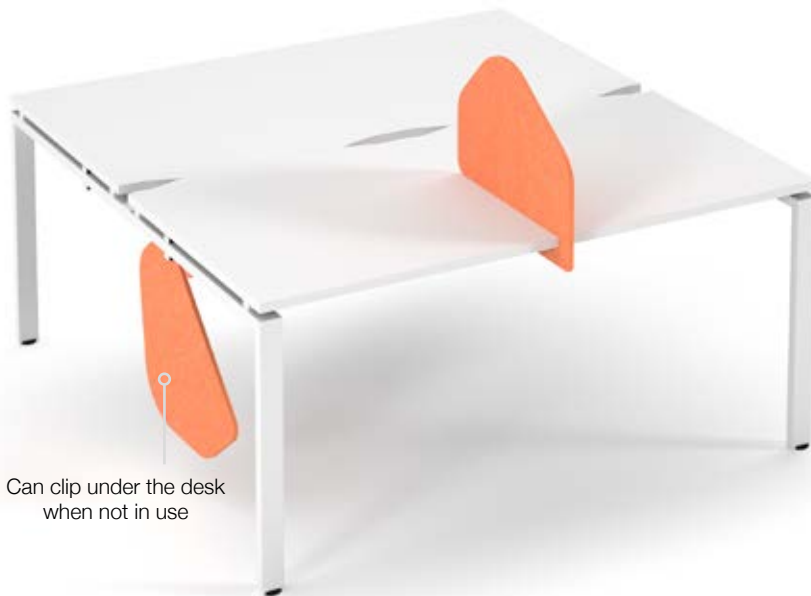

Can clip under the desk when not in use

Frameless design which is easy to attach and slide on to any desk or table

Slide-on dividers can easily be moved to compliment the needs of the agile workspace

Perfect to provide privacy, acoustic properties and a touch of style to your workstation

Acoustic divider manufactured using a minimum of 65% already recycled waste material



CODE	W	D	H	MTO
SWT-SPS	550	12	375-450	£265
SWT-CLP	Optional adhesive clip			£20

MTO

5 week lead time



Orange (O)



Silver Grey (SG)

Please add storage finish when ordering eg. **SWT-SPS** in Orange = **SWT-SPS-O**



SQUARE

CODE	W	D	H	Band A	Band B	Band C
PWS-25-1	595	25	595	£210	£225	£233
PWS-50-1	595	50	595	£240	£256	£266
PWS-25-2	1195	25	1195	£388	£416	£431
PWS-50-2	1195	50	1195	£417	£448	£464

RECTANGLE

CODE	W	D	H	Band A	Band B	Band C
PWR-25-1	595	25	295	£151	£161	£168
PWR-50-1	595	50	295	£180	£193	£200
PWR-25-2	795	25	395	£191	£205	£213
PWR-50-2	795	50	395	£215	£230	£240
PWR-25-3	1195	25	595	£227	£244	£252
PWR-50-3	1195	50	595	£251	£270	£280

TRIANGLE

CODE	W	D	H	Band A	Band B	Band C
PWT-25-1	595	25	595	£210	£225	£233
PWT-50-1	595	50	595	£227	£244	£252
PWT-25-2	1195	25	1195	£388	£416	£431
PWT-50-2	1195	50	1195	£417	£448	£464

HEXAGON

CODE	W	D	H	Band A	Band B	Band C
PWH-25-1	595	25	415	£251	£270	£280
PWH-50-1	595	50	415	£286	£307	£318
PWH-25-2	1195	25	1035	£417	£448	£464
PWH-50-2	1195	50	1035	£475	£510	£528



Piano Tiles are modular, acoustic wall panels that blend aesthetics with sound control. Available in various shapes and colours, they turn empty walls into artistic sound solutions for offices, education, and retail. Piano Tiles can be upholstered in our A,B or C fabric bands.

Can be mixed and matched to create unique patterns and finishes

Lightweight and easy to install onto a flat surface using heavy duty Velcro strips

Excellent acoustic & sound absorption properties with multiple configuration

Ideal to add some colour to open plan offices, education and commercial interiors



MTO

5 week lead time



Chords | Hanging Panels

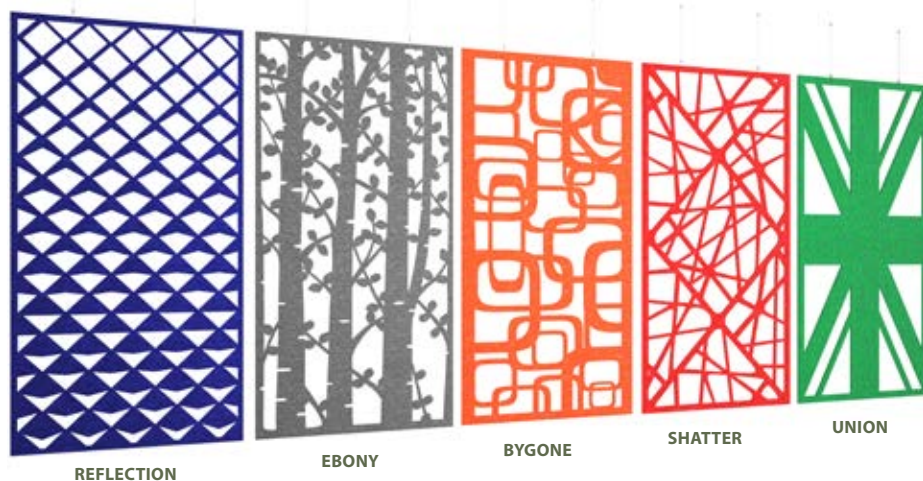
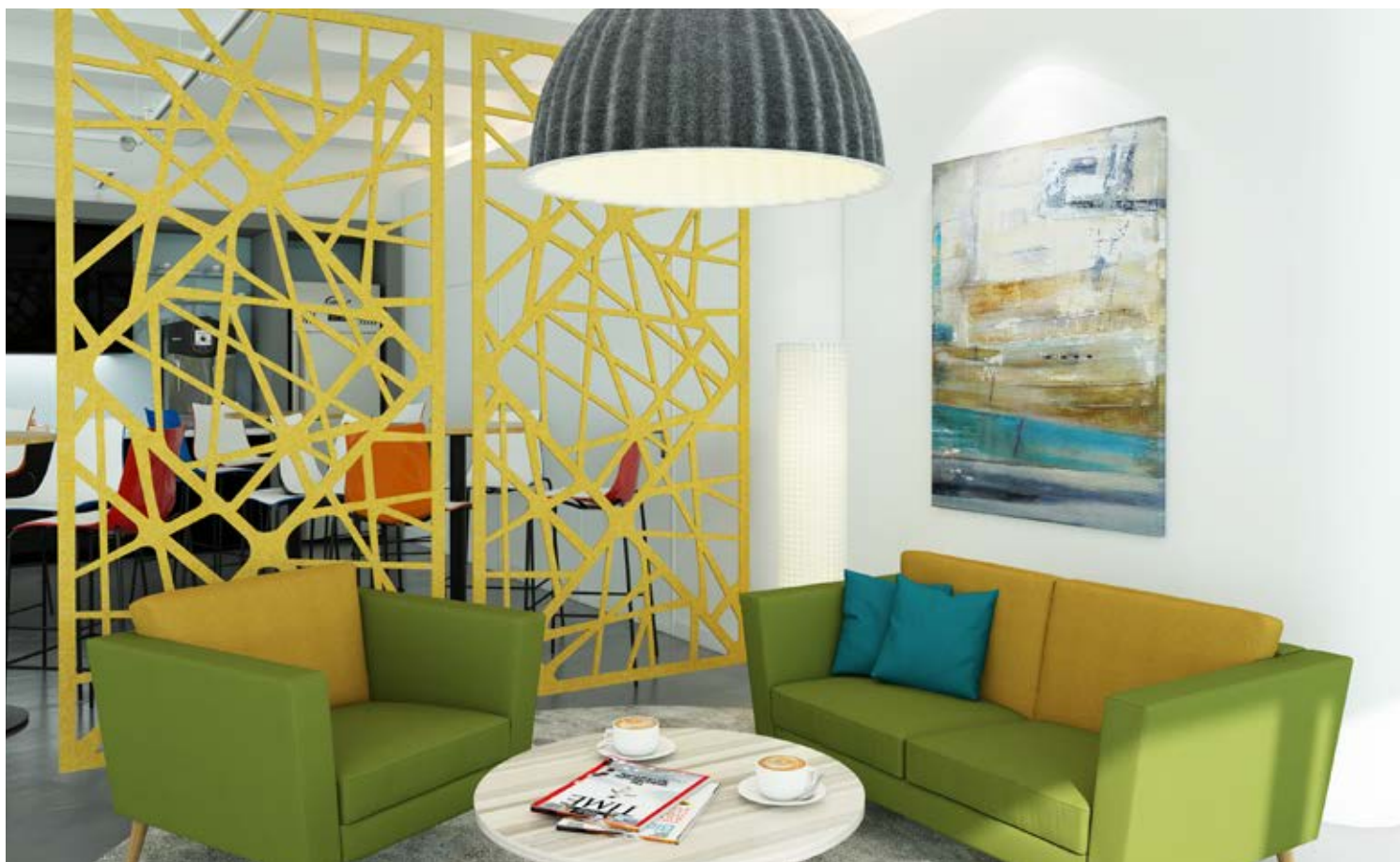

Piano Chords are hanging acoustic panels offered in five unique designs, providing sound absorption while enhancing aesthetics. They are hung from the ceiling with brackets, serving as stylish divider in interior environments. Manufactured from PET in a choice of seven colours.

Can be mixed and matched to create unique designs and add colour

Lightweight and easy to install onto a flat surface using heavy duty Velcro strips

Seamless combination of acoustics and aesthetics with 5 pattern options

Ideal for dividing workspaces and absorbing sound in open plan office environments



REFLECTION

CODE	W	D	H	QTY	MTO
PC126-R	600	12	1200	4	£1589
PC2412-R	1200	12	2400	1	£1399

EBONY

CODE	W	D	H	QTY	MTO
PC126-E	600	12	1200	4	£1589
PC2412-E	1200	12	2400	1	£1399

BYGONE

CODE	W	D	H	QTY	MTO
PC126-B	600	12	1200	4	£1589
PC2412-B	1200	12	2400	1	£1399

SHATTER

CODE	W	D	H	QTY	MTO
PC126-S	600	12	1200	4	£1589
PC2412-S	1200	12	2400	1	£1399

UNION

CODE	W	D	H	QTY	MTO
PC126-U	600	12	1200	4	£1589
PC2412-U	1200	12	2400	1	£1399

6 week lead time



Please add finish when ordering eg. PC126-B in Orange = PC126-B-O

MTO

Scales | Suspended Panels



PIANO ACOUSTICS

Piano Scales are versatile suspended acoustic panels that improve sound quality in communal spaces, such as meeting rooms and dining areas. Their modern design reduces reverberation, enhancing communication and reducing disturbances. Manufactured from PET in a choice of seven colours.

Lightweight and easy to install onto a flat surface using heavy duty Velcro strips

Available in a wide range of colour options to suit any interior decor

Environmentally-friendly and manufactured from minimum 65% recycled materia

Ideal for absorbing sound in meeting spaces and boardrooms

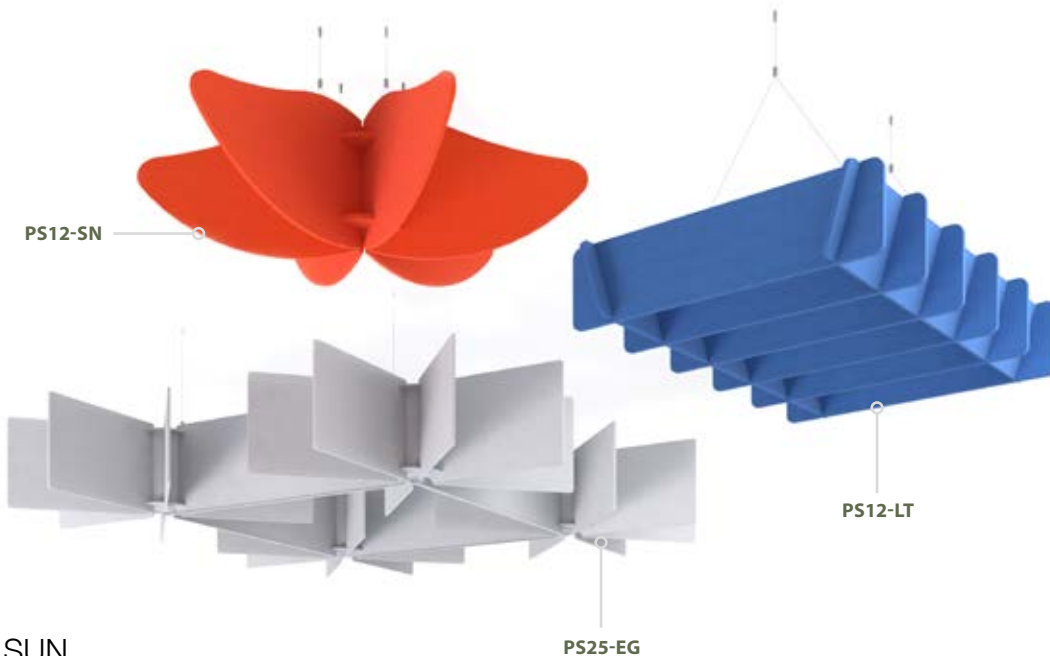

SUN

CODE	W	D	H	MTO
PS12-SN	1200	1200	300	£1399

ECHO GRID

CODE	W	D	H	MTO
PS25-EG	2500	2500	300	£1463

LATTICE

CODE	W	D	H	MTO
PS12-LT	1200	800	300	£1209
PS24-LT	2400	800	300	£1589

6 week lead time



Dark Blue (DB) Dark Green (DN) Dark Grey (DG) Silver Grey (SG) Orange (O) Red (R) Yellow (Y)

Please add finish when ordering eg. PS12-LT in Silver Grey = PS12-LT-SG

Solo | Booth



Private acoustic space to make personal phone calls or one-to-one video conferencing. These sturdy single person pods come complete with a standing height table top which provides space for laptops or notebooks if necessary. Piano Solo is designed to keep noise from the outside out

Offers a high degree of personal privacy with good sound acoustic properties

Ideal when making phone calls and video conferencing away from the desk

Solves the lack of private areas in noisy open plan offices offering privacy

Specifically designed to enhance acoustic comfort in the workplace

CODE	W	D	H	MTO
PSB1	1200	1000	2150	£6728



6 week lead time



MTO

Dark Blue (DB) Dark Green (DN) Dark Grey (DG) Silver Grey (SG) Orange (O) Red (R) Yellow (Y)

Please add interior finish when ordering eg. PSB1 in Red = PSB1-R

Keys | Floor Standing Screens



PIANO ACOUSTICS

An innovative alternative to traditional floor screens. Comprising three rotating acoustic blinds on a sturdy base, it offers privacy while allowing for flexible space arrangements. The fabric covered acoustic panels rotate a full 360° to provide visual protection or open the space as required.

Free-standing office screen with silver base and three rotating panels

Screen unit can be positioned in a row or at 45° angles for different directions

Fully upholstered panels in a range of fabrics with excellent acoustic properties

Lightweight, simple to install and easy to manoeuvre for enhanced privacy

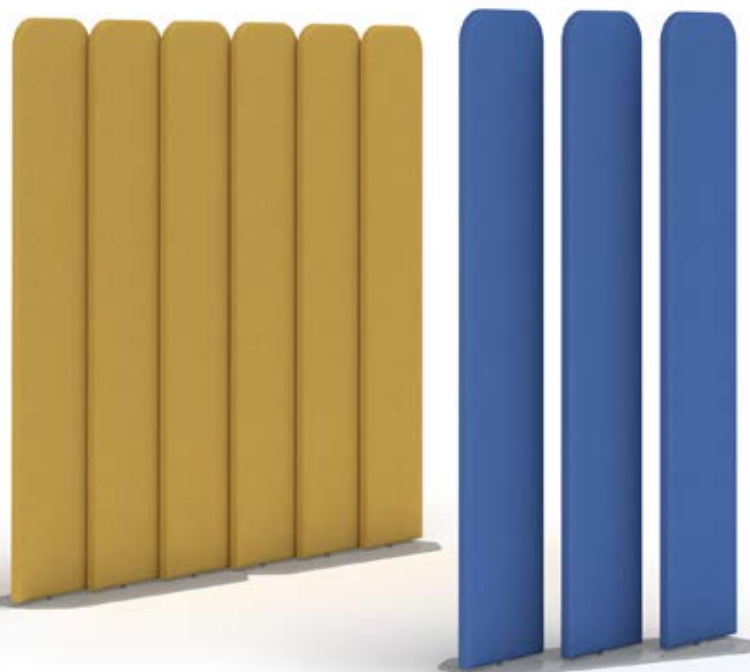
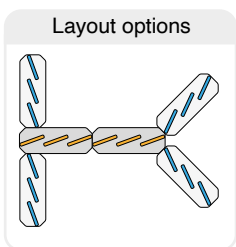

CODE	W	D	H	Band A	Band B	Band C	Band D	Band E
PKS003	870	300	1600	£1004	£1057	£1163	£1268	£1374



MTO

4 week lead time



A minimalist desk setup featuring a white coat rack with a white blazer and a white tie, set against a light beige background. The coat rack is a simple, modern design with a central vertical post and several horizontal arms. A white blazer is draped over one of the arms, and a white tie with a subtle plaid pattern is draped over another. The background is a solid, light beige color, creating a clean and uncluttered aesthetic.

ACCESSORIES

SIMPLIFY YOUR DESK

MONITOR ARMS



LUNA
180

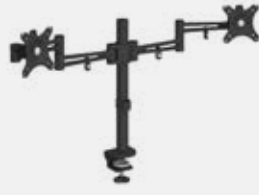

TRITON
180

CPU HOLDER



NEON
182



HALO
183

HEIGHT ADJUSTABLE CONVERTOR



SORA
184

CABLE MANAGEMENT



CABLE TRAYS
185



CABLE SPINE
185

STANDS



UMBRELLA COAT & HAT
186

SEATING ACCESSORIES



PARTS
187

Luna | Monitor Arms



The Luna range of single and double monitor arms enhances office flexibility, ensuring user comfort and reducing lower neck pain caused by incorrect monitor positioning. Luna strong construction allows for monitors from 17 to 30 inch and up to a weight of 10kg for each arm.

Available in three colours and supplied with desk clamp fitting to fit on the back of desks

One touch height adjustment with quick removable, VESA mounting plate

Rotating the monitor holders allows landscape or portrait positioning

Quick, easy installation arms come complete with clips for cable management

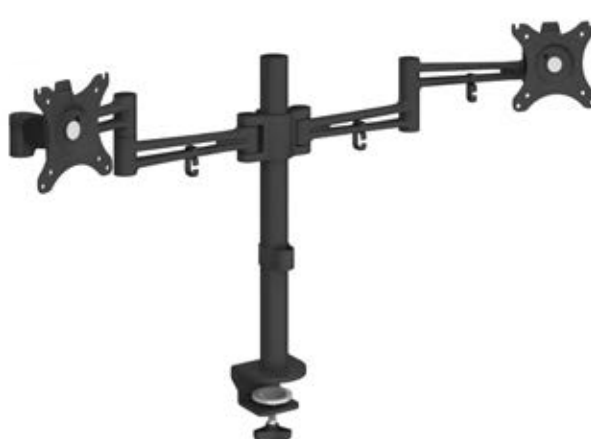

CODE	DESCRIPTION	RRP
LSMARM	Luna single flat screen monitor arm	£94
LDMARM	Luna double flat screen monitor arm	£156

Specifications



Each arm

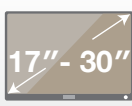

Each arm



Black (K)



Silver (S)



White (WH)

Triton | Monitor Arms



ACCESSORIES

Triton monitor arms feature a gas spring hovering system for smooth adjustments tailored to the user's needs. Their space-saving double arm design positions monitors side-by-side, freeing desk space, and includes a built-in USB port. Monitors sizes from 17 to 32 inch can be attached per arm.



Supports clamp or grommet installation with discreet cable management

High-quality ball joint tilts and quick-release VESA plate for easy adjustment

Gas spring hovering system adjusts monitor height with 90° to 15° tilt range

Double monitor arm has space-saving gas spring arm with 2 built-in USB ports

CODE	DESCRIPTION	RRP
TGSMARM	Triton single flat screen monitor arm	£202
TGDMARM	Triton double flat screen monitor arm	£295

Specifications



Single



Double



Each arm



Black (K)



Silver (S)



White (WH)

Neon | Under Desk CPU Holder



The Neon CPU holder is easy to install, fitting to the underside of the desk surface and keeps your computer off the floor or desk, protecting it from dust and damage. Available in silver and white, its unique captive foot accommodates various CPU sizes while ensuring cable and port access.

Specifications

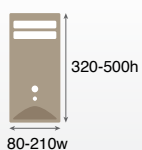

Under desk easy adjustable CPU holder for use on 25mm thick desktops

Height adjustment to fit computer towers from 320mm to 500mm

Width adjustment for 50-77mm, 100-110mm or 128-210mm CPUs

Designed to hold CPUs with a weight capacity up to 20Kg

CODE	DESCRIPTION	W	D	H	RRP
NECPU	Neon under desk CPU holder	130	250	320-500	£150



Halo | Large 4 Sided CPU Holder



ACCESSORIES

The highly-durable Halo 4-sided CPU holder mounts under the work surface, elevating the computer to protect it from dirt and accidental damage. It features easy installation, 180° rotation, and adjustable height and width for various CPU sizes.

Specifications

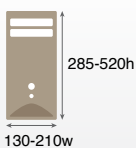

No more reaching around the CPU, simply spin around to see what you're looking for

Protective padding included to better protect the CPU from scratches or damage

Under-desk installation saving more space and keeping your CPU dust-free

Robust heavy duty and durable steel CPU mounting bracket

CODE	DESCRIPTION	W	D	H	RRP
HLCPU	Halo large under desk CPU holder	240	120	210-520	£125



Black (K)



Silver (S)



White (WH)

Sora | Height Adjustable Desk Converter



Transform your desk into a standing desk with our converter, offering seamless transitions between sitting and standing. The gas spring lift enables height adjustments, and the separate keyboard and mouse deck keeps the monitor at eye level. Available in a black contemporary finish.

Specifications

120-505mm
Height range

15
kg



Turns a regular desk into a standing desk without having to replace the desk

Smooth height adjustment and quick-release, with removable keyboard tray

Work surface size of 880 x 415mm with a keyboard tray size 880 x 308mm

Allows the user to sit, stand, and incorporate movement into the working day

CODE	DESCRIPTION	W	D	H	RRP
SHAW	Sora height adjustable sit stand desk converter	880	385	120-505	£425



Black
(K)



Our practical cable management solutions enhance office organisation by providing smart ways to power workstations and transfer data while keeping cables tidy. This collection of customisable options ensure a clutter-free workspace tailored to your individual needs.

Drop down silver cable management tray in 4 sizes with plastic end covers

Specify cable tray sizes shorter than the desk size e.g. use WB1400-S with a 1600mm desk

Cable spines are a simple attractive solution to carry cables from floor to desk 760mm long

Unique cable spine rotating desk fixing with oval shaped segments and large weighted base

CABLE TRAY



CODE	USAGE	W	D	H	RRP
WB0800-S	Fits 1000 wide desk	800	120	60	£91
WB1000-S	Fits 1200 wide desk	1000	120	60	£98
WB1200-S	Fits 1400 wide desk	1200	120	60	£109
WB1400-S	Fits 1600 wide desk	1400	120	60	£113

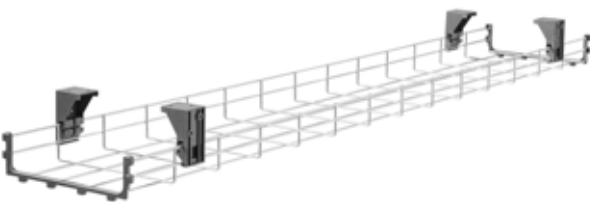

CODE	USAGE	W	D	H	RRP
DWB0800	Fits 1000 wide desk	800	200	100	£99
DWB1000	Fits 1200 wide desk	1000	200	100	£114
DWB1200	Fits 1400 wide desk	1200	200	100	£125
DWB1400	Fits 1600 wide desk	1400	200	100	£140



CABLE SPINE

CODE	W	D	H	RRP
ROSP	80	80	760	£78



Silver (S)



Black (BL)



Grey (GR)



Opaque (OP)

Accessories | Coat & Umbrella Stands



PMC001



PMC002



PMC003

CODE	W	D	H	RRP
PMC001	470	470	1720	£114
PMC002	450	450	1730	£145
PMC003	450	450	1730	£109

Keep your office organised with our stylish coat and umbrella stands, offering ample hooks at varying heights. These versatile stands provide designated storage for coats, bags, and umbrellas, keeping essentials out of the way. Available in individual contemporary finishes.

Wide clothing friendly hooks complete with large splayed bases for stability

3 designs in different finishes and styles all easy to assemble with no tools require

Handy for storing personal items instead of bundling coats into a cupboard

Plenty of space with an area to store umbrellas if the weather turns bad



Grey (PMC001)



Black/Chrome (PMC002)



Black (PMC003)

Accessories | Seating Parts

Nylon 5 Star Base



CODE	DESCRIPTION	RRP
BAS01	5 star base	£63

- Strong and durable nylon 5 star base
- 635mm diameter suitable for majority of chairs

Chrome 5 Star Base



CODE	DESCRIPTION	RRP
BAS02	5 star base	£94

- Strong, scratch resistant chrome 5 star base
- 635mm diameter suitable for majority of chairs

Replacement gas stem



CODE	DESCRIPTION	RRP
GAS01	Gas stem	£50

- Black 9" gas stem which is simple to replace
- Class 3 certified in black

Glides



CODE	DESCRIPTION	RRP
GLD01	5 glides	£25

- Simple to replace and prevents chair from moving
- Ideal for educational environments

Soft Castor



CODE	DESCRIPTION	RRP
CAS01	5 soft castors	£22

- Soft edge castors with 50mm diameter
- Ideal for use on hard flooring

Brake Loaded Castor



CODE	DESCRIPTION	RRP
CAS02	5 brake loaded castors	£22

- Castor locks when weight is applied
- 50mm diameter



POWER & DATA

WE'RE LEADING THE CHARGE

DESKTOP POWER



NEBULA
190



HUBBLE
191



CHROMA
191

PANEL MOUNTED POWER



PHASE
192



PROTON
192

ON SURFACE POWER



INCA
193

IN SURFACE POWER



ION
193



PIXEL
194



ECLIPSE
194



THOLUS
195

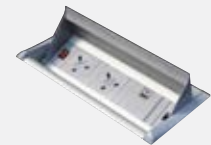

AERO
195

UNDER DESK POWER AND DATA



POWER BARS
196



CONNECTOR LEADS
196



STARTER LEADS
196



Multiple placement using a clamp that allows the unit to be attached on any edge of a desk

Available as a double 240v socket, or a single 240v socket with USB-C and USB-A inputs

Nebula's versatility makes it stand out amongst its desktop module counterparts.

Manufactured and tested to BS1363-2, BS5733 (1,2 & 3) and ASTA Approved



CODE	DESCRIPTION	W	D	H	RRP
NEB1	2x 240v UK Sockets	107	70	63	£95
NEB2	1x 240v UK Socket 30W USB-C, 27W USB-A	107	70	63	£150
NEB3	2x 240v UK Socket 30W USB-C, 27W USB-A	157	70	63	£175

STOCKED



White
(WH)



Black
(K)



Grey
(G)

Starter lead required sold separately



Hubble | Desktop



Twin clamp brackets for better stability for table tops 5mm-35mm thick

Tough and elegant aluminium body with coloured fronts that is built to last

Fun and distinctive power modules available in multiple colour options

BS5733 and UL962A certified and CE marked as applicable



HBL-1-R



HBL-2-DB



HBL-3-K



TWIN RJ45 SOCKETS



UK FUSED SOCKET



USB FAST CHARGE (A&C)

CODE	DESCRIPTION	W	D	H	MTO
HBL-1	1 x UK socket, 1 x USB fast charge (A&C connectors)	150	49	72	£701
HBL-2	1 x UK socket, 1 x USB fast charge (A&C connectors), 2 x RJ45 sockets	218	49	72	£909
HBL-3	2 x UK sockets, 1 x USB fast charge (A&C connectors)	218	49	72	£317

MTO

3-4 week lead time

HBL-3 only available in Black (K) and White (WH)



Black (K)



Dark Blue (DB)



Light Green (LG)



Orange (OR)



Red (R)



White (WH)



Yellow (Y)

Starter lead required sold separately



Chroma | Desktop



Excellent clamping fixtures with top and bottom fix options available

A practical and stylish addition to clip on to any desktop

Black & white units with 30 and 60 degree positioning

Manufactured and tested in accordance with BS6396:2008



CRM-1-K



CRM-2-WH



CRM-3-WH



TWIN RJ45 SOCKETS



UK FUSED SOCKET



USB FAST CHARGE (A&C)

CODE	DESCRIPTION	W	D	H	STOCKED	MTO
CRM-1	2 x UK sockets, 1 x USB fast charge (A&C connectors)	279	94	62	£249	NA
CRM-2	2 x UK sockets, 2 x RJ45 sockets	279	94	62	NA	£135
CRM-3	2 x UK sockets, 1 x USB fast charge (A&C connectors), 2 x RJ45 sockets	333	94	62	NA	£280

3-4 week lead time



Black (K)

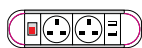

White (WH)

Starter lead required sold separately





Phase | Panel Mounted

On-surface or under-surface fitting solutions with hidden fitting bracket

Two socket apertures can be configured with power, charging or data

High-strength and flame retardant polycarbonate main body and back mouldings

All units fitted with fuses to comply to BS6396 and CE marked



PH-1-K



CODE	DESCRIPTION	W	D	H	RRP
PH-1	1 x UK socket, 1 x USB fast charge (A&C connectors)	115	63	67	£400

STOCKED

PH-1 only

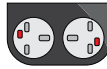

Black (K)

MTO

3-4 week lead time

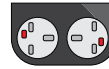

Black (K)

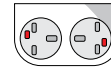

White (WH)

Starter lead required sold separately



Proton | Panel Mounted

Designed for panel mounting in soft seating or screens

To cater for the needs of any corporate or educational environment

Can be snapped into panels of 16mm or screw fixed into any suitable surface

Manufactured to enable compliance with BS6396/BS7671



PTN-1T-K



PTN-25-KG-K



PTN-1T-KG-K



CODE	DESCRIPTION	W	D	H	STOCK	ORDERED
PTN-1T-KG	1 x USB fast charge (A&C connectors)	64	8	60	N/A	£321
PTN-1T	1 x UK socket, 1 x USB fast charge (A&C connectors)	117	8	60	£342	N/A
PTN-25-KG	2 x UK sockets	117	8	60	N/A	£182

STOCKED

PTN-1T only



Black (K)

ORDERED

3-4 week lead time



Black (K)

Starter lead required sold separately



Required cut out sizes

50mm

PTN-1T-KG

50 x 103mm

PTN-1T
PTN-25-KG

Inca | On-surface



4 usable faces offering a wide range of configurations for power and charging

Free-standing on desk module or a desk/table grommet fixing

Can also be used free-standing on table tops ideal for meetings

Flame retardant ABS plastic body independently certified to comply with BS 5733



79-1-K



79-2-WH



TWIN RJ45 SOCKETS



HDMI SOCKET

CODE	USAGE	DESCRIPTION	W	D	H	MTO
79-1	Cut out required	2 x UK sockets, 2 x USB fast charge (A&C connectors)	140	140	72	£570
79-2	Free standing	2 x UK sockets, 2 x USB fast charge (A&C connectors)	140	140	72	£570

MTO

Required cut out size

80mm

3-4 week lead time



Black (K)



Grey (G)



White (WH)

Starter lead required sold separately



Ion | In Surface



Space saving power solution for café and dining tables

Power and connectivity conveniently placed right where you might need it

Ultra-compact to fit in 60mm or 80mm port holes or in table cutouts

BS5733 certified and conforms to CE European directives



ION-1-K



ION-2-WH



UK FUSED SOCKET



USB TYPE A

CODE	DESCRIPTION	W	D	H	RRP
ION-1	1 x UK socket, 1 x USB Charger (type A)	100	100	2	£78

Required cut out size

60mm

80mm



Black (K)



White (WH)

Starter lead required sold separately





Pixel | In Surface

Ideally suited to breakout areas, smaller meeting rooms, and hotel rooms

The perfect choice for space saving installations and discreet power solutions

CAT6 RJ45 outlet with 2m flylead & HDMI 1.3 Hi-speed outlet with 1.8m flylead

Sweeping organic curves ensure protection against liquid ingress as required by BS6396



UK FUSED SOCKET



USB FAST CHARGE (A&C)



TWIN RJ45 SOCKETS



HDMI SOCKET



PX-2-Y



PX-1



PX-3-DB

Required cut out size

80mm

STOCKED

MTO

CODE	DESCRIPTION	W	D	H	STOCKED	MTO
PX-1	1 x UK socket, 1 x USB fast charge (A&C connectors)	90	90	16	£342	£342
PX-2	1 x UK socket, 1 x HDMI socket	90	90	16	N/A	£487
PX-3	1 x UK socket, 2 x RJ45 sockets	90	90	16	N/A	£311

PX-1 only



Black (K)

3-4 week lead time



White & Silver Bevel



Dark Blue (DB)



Light Green (LG)



Orange (OR)



Red (R)



White (WH)



Yellow (Y)

Starter lead required sold separately



Eclipse | In Surface

Designed to operate in the closed or open position

For fitting into a wide range of formal and informal office furniture

Total flexibility to meet the demands of any power and data requirement

Manufactured to enable compliance with BS6396



UK FUSED SOCKET



USB FAST CHARGE (A&C)



TWIN RJ45 SOCKETS



HDMI SOCKET



ENDD2-K



ENDD1-K



ENDD4-K

CODE	DESCRIPTION	W	D	H	RRP	MTO
ENDD1	2 x UK sockets, 1 x USB fast charge (A&C connectors)	300	150	3	£590	N/A
ENDD2	2 x UK sockets, 1 x USB fast charge (A&C connectors), 1 x RJ45 socket, 1 x HDMI socket	300	150	3	N/A	£1025
ENDD4	4 x UK sockets	459	150	3	N/A	£559

Required cut out size

132 x 272mm

ENDD1
ENDD2

132 x 430mm

ENDD4

STOCKED

ENDD1-K
Black



Black/Silver (K)

3-4 week lead time

MTO



Black/Silver (K)

Starter lead required sold separately



Tholus | In Surface



Aluminium extrusion body with 3mm mild steel end cap

Suitable for table tops 10mm-30mm thick and secured by the 4 screw clamps

CAT6 RJ45 outlet with 2m flylead & HDMI 1.3 Hi-speed outlet with 1.8m flylead

Certified and tested to British standard BS1363/5733



THL-1-S



THL-2-S



UK FUSED SOCKET



USB FAST CHARGE (A&C)



TWIN RJ45 SOCKETS



HDMI SOCKET

CODE	DESCRIPTION	W	D	H	MTO
THL-1	4 x UK sockets, 2 x USB fast charge (A&C connectors)	220	155	22	£1253
THL-2	4 x UK sockets, 2 x USB fast charge (A&C connectors), 1 x RJ45 socket, 1 x HDMI socket	300	155	22	£1739

Required cut out sizes

132 x 192mm

THL-1

132 x 272mm

THL-2

3-4 week lead time

MTO



Black/Brushed Steel (S)

Starter lead required sold separately



Aero | In Surface



Aero flip power modules in grey with distinctive low profile

Ideal for boardroom environment and large meeting areas

Sloping edge design ensures cables run flat and smoothly on exit

Flame retardant ABS plastic body independently certified to comply with BS 5733

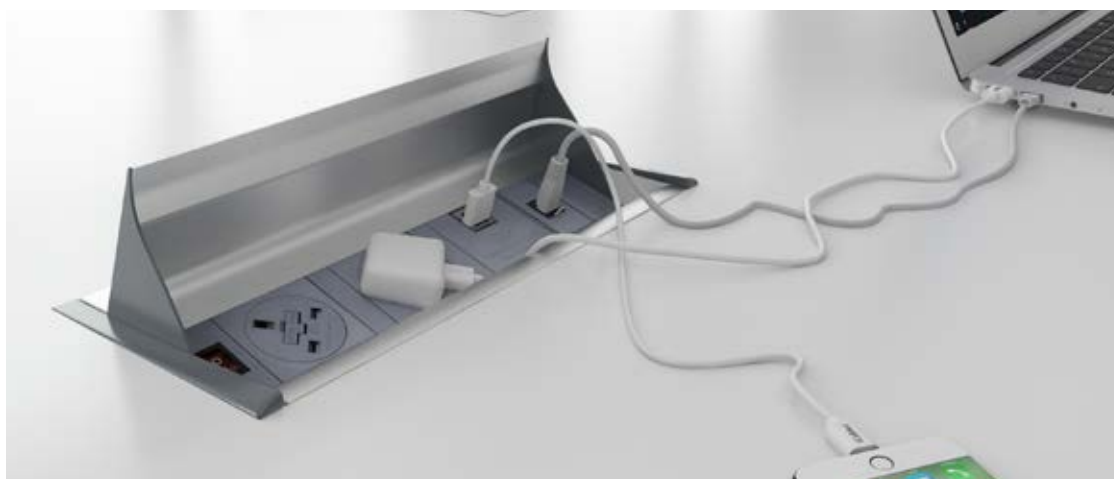

APD2PINF/1S-K



APD2PINF/1S/2D-K



APD2PINF/1S/1D/1T-K



TWIN RJ45 SOCKETS



UK FUSED SOCKET



USB FAST CHARGE (A&C)

CODE	DESCRIPTION	W	D	H	RRP	MTO
APD2PINF/1S	2 x UK sockets	255	150	13-63	N/A	£171
APD2PINF/1S/2D	2 x UK sockets, 2 x RJ45 sockets	255	150	13-63	N/A	£207
APD2PINF/1S/1D/1T	2 x UK sockets, 1 x RJ45 socket, 1 x USB fast charge (A&C connectors)	312	150	13-63	£342	N/A

Required cut out sizes

132 x 215mm

APD2PINF/1S-K
APD2PINF/1S/2D-K

132 x 272mm

APD2PINF/1S/1D/1T-K

STOCKED

APD2PINF/1S/1D/1T only



Grey/Silver (K)

MTO

3-4 week lead time

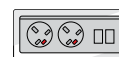

Grey/Silver (K)

Starter lead required sold separately





Power Bar



CODE	DESCRIPTION	RRP
PMK205-E	2 x UK sockets	£68

- UK sockets which incorporate fuses as standard
- BS6396 compliant and CE marked

Power Bar



CODE	DESCRIPTION	RRP
PMK405-E	4 x UK sockets	£78

- UK sockets which incorporate fuses as standard
- BS6396 compliant and CE marked

Power Bar



CODE	DESCRIPTION	RRP
PMK305-E	3 x UK sockets	£73

- UK sockets which incorporate fuses as standard
- BS6396 compliant and CE marked

Mains Starter Lead



CODE	DESCRIPTION	RRP	CODE	DESCRIPTION	RRP
ML2M-B	2m mains lead	£55	ML6M-B	6m mains lead	£61
ML3M-B	3m mains lead	£59	ML7M-B	7m mains lead	£63
ML4M-B	4m mains lead	£57	ML8M-B	8m mains lead	£65
ML5M-B	5m mains lead	£59	ML9M-B	9m mains lead	£70

- Mains leads with UK 3 pin plug
- Female 3 pole connector

Connector Leads



CODE	DESCRIPTION	RRP
DCL15M-B	Connector Lead	£47

- 1.5m connector lead
- Male 3 pole connector to female 3 pole connector

Connector Leads



CODE	DESCRIPTION	MTO
CL3M-B	Connector Lead	£57

- 3m connector lead
- Male 3 pole connector to female 3 pole connector

Product	Type	Recommended for use with	Fitting details	Power cord	Separate mains lead required
Nebula	Clip-On Power Units	Desks	Clamp bracket (supplied)	Hardwired with 500mm lead to male GST Connector	✓
Chroma	Clip-On Power Units	Desks	Clamp bracket (supplied)	Hardwired with 800mm lead to male GST Connector	✓
Hubble	Clip-On Power Units	Desks	Clamp bracket (supplied)	Hardwired with 800mm lead to male GST Connector	✓
Hubble	Clip-On Power Units	Desks	Clamp bracket (supplied)	Hardwired with 800mm lead to male GST Connector	✓
Phase	Multi-Surface Power Units	Meeting Tables / Soft Seating	Clip-on mounting bracket (supplied)	Hardwired with 800mm lead to male GST Connector	✓
Pixel	Multi-Surface Power Units	Meeting Tables	80mm circular grommet hole	Hardwired with 800mm lead to male GST Connector	✓
Ion	Multi-Surface Power Units	Café & Dining Tables / Desks	60 or 80mm circular grommet hole	Hardwired with 800mm lead to male GST Connector	✓
Inca	On-Surface Power Units	Meeting Tables	80mm circular grommet hole	Supplied with a 1M mains lead to 3 pin connector	✗
Proton	Panel Mounted Power Unit	Soft Seating	50mm (PTN-1T-KG) & 103mm x 50mm (PTN-1T/2S) grommet holes	Hardwired with 800mm lead to male GST Connector	✓
Aero	In-Surface Power Units	Boardroom Tables	215mm x 132mm (1S), 215mm x 132mm (1S/2D), 272mm x 132mm (1S/1D/1T), rectangular cutouts	Hardwired with 800mm lead to male GST Connector	✓
Eclipse	In-Surface Power Units	Boardroom Tables	272mm x 132mm (ENDD1-2), 430mm x 132mm (ENDD4), rectangular cutouts	Hardwired with 800mm lead to male GST Connector	✓
Tholus	In-Surface Power Units	Boardroom Tables	192mm x 132mm (THL-1), 272mm x 132mm (THL-2), rectangular cutouts	Hardwired with 800mm lead to male GST Connector	✓
Power Bars	Under-Surface Power Units	Desks	No fitting required	Integrated GST18-3 connectors	✓

TABLE

RANGES

WORKTABLES



3 RANGES
202

BOARDROOM TABLES



8 RANGES
210

MODULAR MEETING TABLES



6 RANGES
228

CAFE & DINNING



6 RANGES
242

COFFEE



4 RANGES
256

LAPTOP



2 RANGES
263

A modern dining or meeting room with long wooden tables and benches. The room features large wall art depicting various fruits and vegetables, and a living wall with greenery and small lights. The overall aesthetic is clean and collaborative.

WORKTABLES

COLLABORATIVE TABLES & BENCHES



ENABLE
202



OTTO
204



SLAB
206

ENABLE

WOODEN FRAMED TABLES

Enable table and benches are part of a bold and contemporary collection of furniture designed to make a real impact. Presenting a multitude of layout options, the range of tables and stools will enable you to create a dynamic, collaborative area for the modern trend of agile working, providing an inspirational and welcoming work area which is fully customisable with power and data, lighting, plant life and much more.



Stocked MFC top finishes

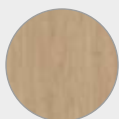

Kendal Oak



Onyx Grey



White

Made-To-Order jumbo laminate top finishes



Volcanic Black



Manhattan Grey



Royal White

Enable | Wooden Framed Tables

Seating & Table



CODE	W	D	H	MTO
ENB500-C	500	500	460	£568

- Ideal for use with Enable table ranges
- Solid wood base and fully upholstered curved seat

CODE	W	D	H	Band A	Band B	Band C	Band D	Band E
ENBLS	380	380	475	£510	£537	£562	£587	£612
ENBU-12	1200	380	475	£701	£726	£752	£778	£803

- 500mm circular coffee table with straight edge tops
- Solid oak leg frames with 25mm MDF table top

Single & Double Worktable



CODE	W	D	H	STOCKED	MTO
ENT16-16	1600	1600	745	£1098	£1770
ENT16-16-CO	1600	1600	745	N/A	£1966

- Promote creativity in the workplace with a table system that inspires
- Solid oak leg frames with complementary benches and stools

CODE	W	D	H	STOCKED	MTO
ENT32-16	3200	1600	745	£1756	£2950
ENT32-16-CO	3200	1600	745	N/A	£3212

- Promote creativity in the workplace with a table system that inspires
- Solid oak leg frames with complementary benches and stools

Triple Worktable



CODE	W	D	H	STOCKED	MTO
ENT48-16	4800	1600	745	£2414	£4127
ENT48-16-CO	4800	1600	745	N/A	£4521

- Promote creativity in the workplace with a table system that inspires
- Solid oak leg frames with complementary benches and stools

STOCKED



Kendal Oak (KO)



Onyx Grey (OG)



White (WH)



Volcanic Black U12000



Manhattan Grey U12204



Royal White U11209

Please add table top colour when ordering eg. ENT16-16 in Kendal Oak = ENT16-16-KO

OTTO

METAL FRAMED TABLES & BENCHES

The Otto table and bench system offers a clever meeting space solution for any office breakout space with its hard-wearing table top and classic leg design. The table and bench combination avoids a mismatched look and adds a consistent look and feel to any space, and if you wish to enhance the look of the bench by including a touch of colour, fabric seat pads can be added to make them more comfortable.



Stocked MFC top finishes

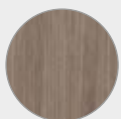

Barcelona
Walnut

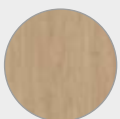

Kendal Oak



White

Frame finishes



Black



Silver

Poseur Tables



CODE	W	D	H	RRP
PTAOT1200	1200	700	1190	£753
PTAOT1800	1800	700	1190	£813

- Robust steel sub-frame with footrest for enhanced ergonomics
- Great for collaboration, work or break times

Dining Tables



CODE	W	D	H	RRP
TAOT1200	1200	700	710	£578
TAOT1800	1800	700	710	£636

- Robust steel sub-frame with choice of silver or black powder coating
- 25mm MFC tops with matching ABS edge available in three finishes

Benches



WOODEN BENCHES

CODE	W	D	H	RRP
LB1050	1050	350	425	£405
LB1650	1650	350	425	£521
HB1050	1050	350	755	£502
HB1650	1650	350	755	£628

- Great for collaboration, work or break times

UPHOLSTERED BENCHES

CODE	W	D	H	Band A	Band B	Band C	Band D	Band E
LBSP1050	1050	350	455	£463	£521	£578	£636	£694
LBSP1650	1650	350	455	£578	£636	£694	£752	£810
HBSP1050	1050	350	785	£628	£682	£736	£791	£845
HBSP1650	1650	350	785	£763	£818	£873	£927	£982

- Upholstered seat pad improves comfort and allows colour contrasting

STOCKED



Black (K)



Silver (S)



Barcelona Walnut (BW)



Kendal Oak (KO)



White (WH)

SLAB

PANEL END TABLES & BENCHES

The Slab table and bench combination makes a real visual impact, with its stylish, chunky laminated top and leg panels that make it stand out in any breakout space or office canteen. The beauty of the Slab table and bench is all in the finish and colour. The table can be produced in a choice of laminate finishes and the bench seating can be complemented with an upholstered seat pad in a wide range of fabrics.



Configure - your Slab bench

Slab benches can be finished with 3 different options to suit any breakout or dining space.

Select up to 3 finishes to create the perfect look.



Mono 

Outer, inner laminate and edge detail all one colour



Duo 

Outer & inner laminate one colour, with different colour edge detail



Trio 

Outer, inner laminate and edge detail all different colours

Slab | Panel End Tables & Benches

Poseur Tables

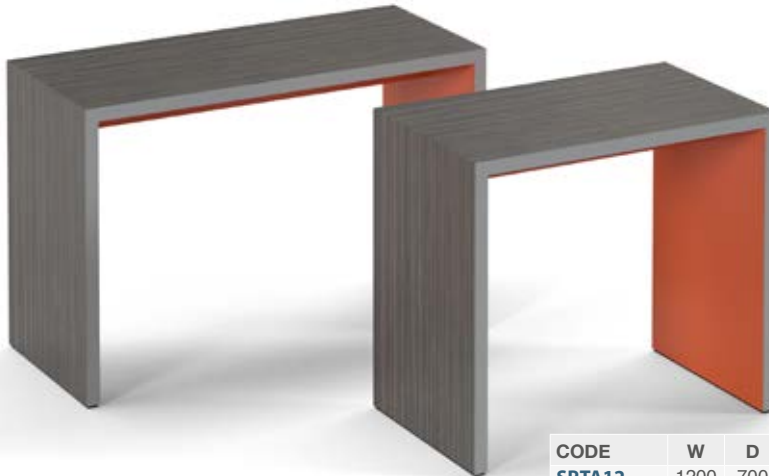

CODE	W	D	H	MTO
SPTA12	1200	700	1050	£1717
SPTA16	1600	700	1050	£1844

- Combine the outer and inner colours with a choice of edge details
- Lends itself perfectly to canteen, bar, meeting and breakout areas

Dining Tables

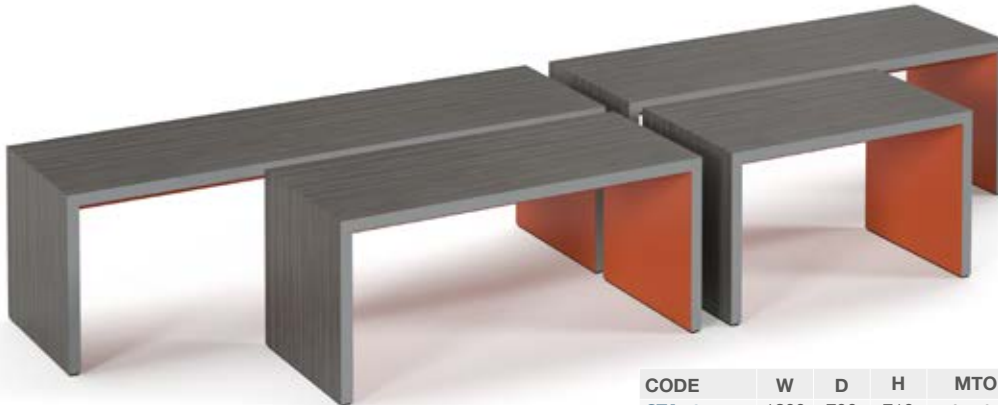

CODE	W	D	H	MTO
STA12	1200	700	710	£1781
STA16	1600	700	710	£2034
STA20	2000	700	710	£2289
STA24	2400	700	710	£2541

- Durable laminate tops available in eight contemporary finishes
- Dining height manufactured in 4 different lengths with matching bench seats

Benches

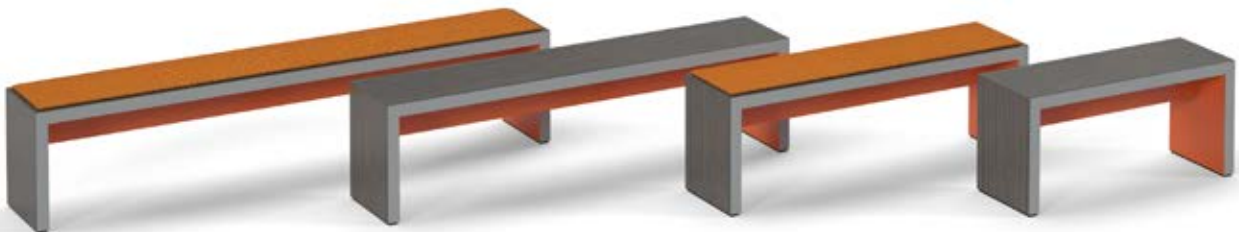

WOODEN BENCHES

CODE	W	D	H	MTO
SB10	1000	350	460	£828
SB14	1400	350	460	£956
SB18	1800	350	460	£1018
SB22	2200	350	460	£1082

- Lends itself perfectly to breakout areas

UPHOLSTERED BENCHES

CODE	W	D	H	Band A	Band B	Band C	Band D	Band E
SBU10	1000	350	490	£891	£925	£956	£1005	£1051
SBU14	1400	350	490	£1051	£1076	£1133	£1191	£1240
SBU18	1800	350	490	£1216	£1273	£1305	£1387	£1449
SBU22	2200	350	490	£1273	£1317	£1380	£1414	£1556

- Combine the outer and inner colours with a choice of edge details



Low bench



Black 001



Blue 001



Grey 018



Orange 002



Ash 003



Oak 011



Zebrano 005



Striped woodmix 001



BOARDROOM

EXECUTIVE TABLE SYSTEMS



ELEV8² TOUCH
210



ADAPT
212



FUZE
214



ARROW HEAD
216



TRUMPET BASE
218



ETERNAL
220



RADIAL LEG
222



ANSON
224

ELEV8² TOUCH

SIT STANDING MEETING TABLES

The Elev8² Touch height adjustable tables combine unique design with versatility to transform corporate spaces like boardrooms into flexible meeting places. The majority of boardroom meeting are sedentary environments, so you can vary your position from sitting to standing allowing for a variety of postures to be more physically active throughout the meeting.



Frame finishes



Black

Silver

White

Stocked finishes



Beech

Oak

White

Grey Oak

Made-to-Order finishes

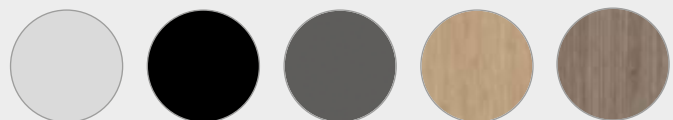

Light Grey

Black

Onyx Grey

Kendal Oak

Barcelona Walnut

Elev8² Touch | Height Adjustable

Rectangular Boardroom Table



CODE	W	D	H	STOCKED	MTO
EVTBT18	1800	1000	650-1250	£1743	£1797

- Rectangular table 1800mm long with adjustability from 650mm-1250mm
- Powerful twin motors raise and lower the table top at a 39db noise level

Add-on Unit



CODE	W	D	H	STOCKED	MTO
EVTBT18-AB	1800	1000	650-1250	£1549	£1598

- Extend into a modular boardroom table system with single add-on unit and brackets
- The three base columns of the straight and add-on table stay perfectly synced

Rectangular Boardroom Table



CODE	W	D	H	STOCKED	MTO
EVTBT20	2000	1000	650-1250	£1883	£1941

- Rectangular table 2000mm long with adjustability from 650mm-1250mm
- Powerful twin motors raise and lower the table top at a 39db noise level

Add-on Unit



CODE	W	D	H	STOCKED	MTO
EVTBT20-AB	2000	1000	650-1250	£1687	£1739

- Extend into a modular boardroom table system with single add-on unit and brackets
- The three base columns of the straight and add-on table stay perfectly synced

Boat Shape Boardroom Table



CODE	W	D	H	STOCKED	MTO
EVTBT24R	2400	800-1300	650-1250	£1951	£2012

- Radial boardroom table with 25mm tops available in a choice of five wood finishes
- Powerful twin motors raise and lower the table top at a 39db noise level

Radial End Boardroom Table



CODE	W	D	H	STOCKED	MTO
EVTBT24	2400	1000	650-1250	£1951	£2012

- Radial end boardroom table with 25mm tops and impact resistant ABS edging
- Powerful twin motors with a max weight loading of 160kg

FRAMES

STOCKED

MTO - 3 week lead time



Please add frame finish followed by table top colour when ordering eg. **EVTBT18** with Silver frame in Oak = **EVTBT18-S-O**

ADAPT

CONFIGURABLE TABLE SYSTEM

Beautifully designed and aesthetically pleasing, the Adapt boardroom table comprises a sturdy steel subframe and table tops which take on a floating appearance. Table legs can be shared, making it a cost effective and practical conference collection with robust customisable options for meeting room and boardroom needs.



Frame finishes

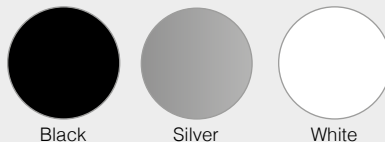

Stocked finishes

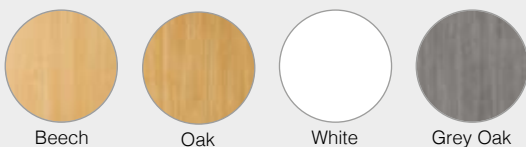

Made-to-Order finishes



Adapt | Configurable System

Square Boardroom Tables



CODE	W	D	H	STOCKED	MTO
EBT1212	1200	1200	725	£853	£866
EBT1616	1600	1600	725	£1048	£1076
EBT1616-CO	1600	1600	725	£1048	£1076



-CO with 132mm x 272mm cutout

- Single square boardroom table with 25mm tops & impact resistant ABS edging
- Sturdy steel framework and bench tops which take on a floating appearance

Add-on Units



CODE	W	D	H	STOCKED	MTO
EBT1212-AB	1200	1200	725	£563	£576
EBT1616-AB	1600	1600	725	£734	£753
EBT1616-AB-CO	1600	1600	725	£734	£753



-CO with 132mm x 272mm cutout

- Single straight add-on table with 25mm tops & impact resistant ABS edging
- Recessed leg is positioned in the centre of the tables and can be extended

Rectangular Boardroom Tables



CODE	W	D	H	STOCKED	MTO
EBT2412	2400	1200	725	£1325	£1452
EBT3216	3200	1600	725	£1674	£1800
EBT3216-CO	3200	1600	725	£1674	£1800



-CO with 132mm x 272mm cutouts

- Rectangular boardroom table with 25mm tops & impact resistant ABS edging
- Extended sturdy steel framework and bench tops which take on a floating appearance

How-to-guide

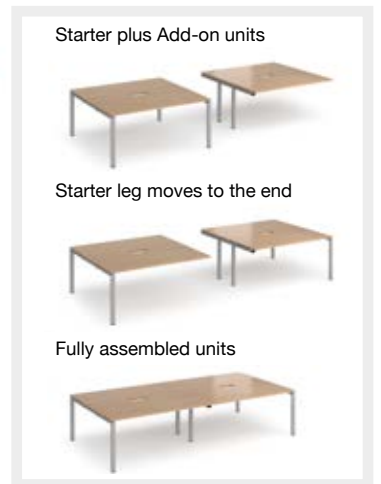
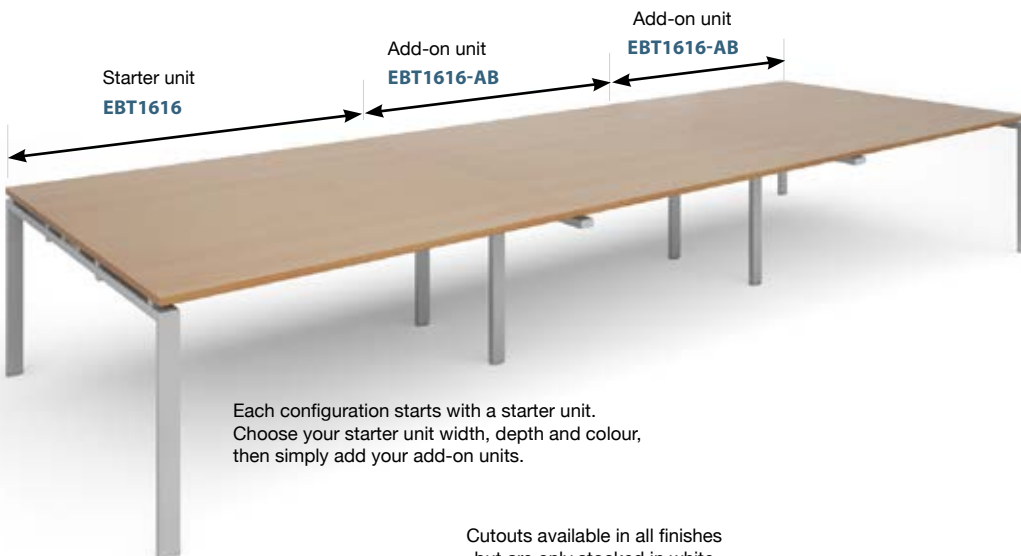

Cutouts available in all finishes but are only stocked in white

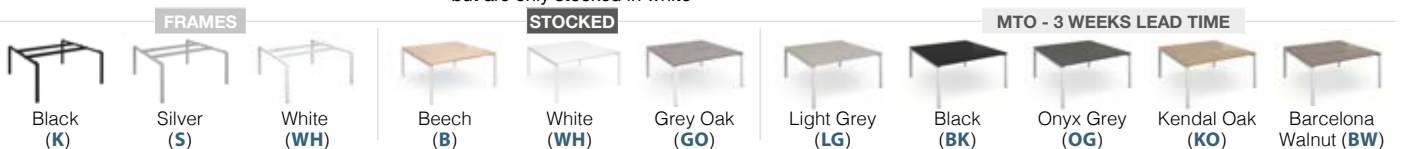

Please add frame finish followed by table top colour when ordering eg. **EBT1616** with Silver frame in Beech = **EBT1616-S-B**

FUZE

WOODEN LEG CONFIGURABLE

Fuze exemplifies elegance, providing a sophisticated boardroom table design which is the perfect answer for a less corporate modern office. The simple, flexible design naturally assimilates to the task or application at hand and the solid oak legs are built to last. Fuze's clean, functional lines and co-ordinated table top finish options offer everything you need to be inspired and productive.



Frame finish



White

Stocked finishes



White

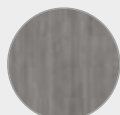

Grey Oak

Made-to-Order finishes



Light Grey



Black

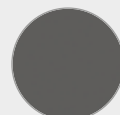

Onyx Grey

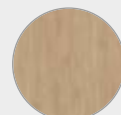

Kendal Oak

Square Boardroom Tables



CODE	W	D	H	STOCKED	MTO
FZBT1616	1600	1600	725	£1164	£1200
FZBT1616-CO	1600	1600	725	£1164	£1200



-CO with 132mm x 272mm cutout

- Single square boardroom table with 25mm tops and steel framework
- Solid oak leg frame provides a modern, stylish twist on boardroom tables

Add-on Units



CODE	W	D	H	STOCKED	MTO
FZBT1616-AB	1600	1600	725	£704	£726
FZBT1616-AB-CO	1600	1600	725	£704	£726



-CO with 132mm x 272mm cutout

- Single straight add-on unit square table with 25mm tops & solid oak leg frame
- Recessed leg is positioned in the centre of the tables and can be extended

Rectangular Boardroom Tables



CODE	W	D	H	STOCKED	MTO
FZBT3216	3200	1600	725	£1889	£1948
FZBT3216-CO	3200	1600	725	£1889	£1948



-CO with 132mm x 272mm cutouts

- Rectangular boardroom table with 25mm tops and steel framework
- Solid oak leg frame provides a modern, stylish twist on boardroom tables

How-to-guide

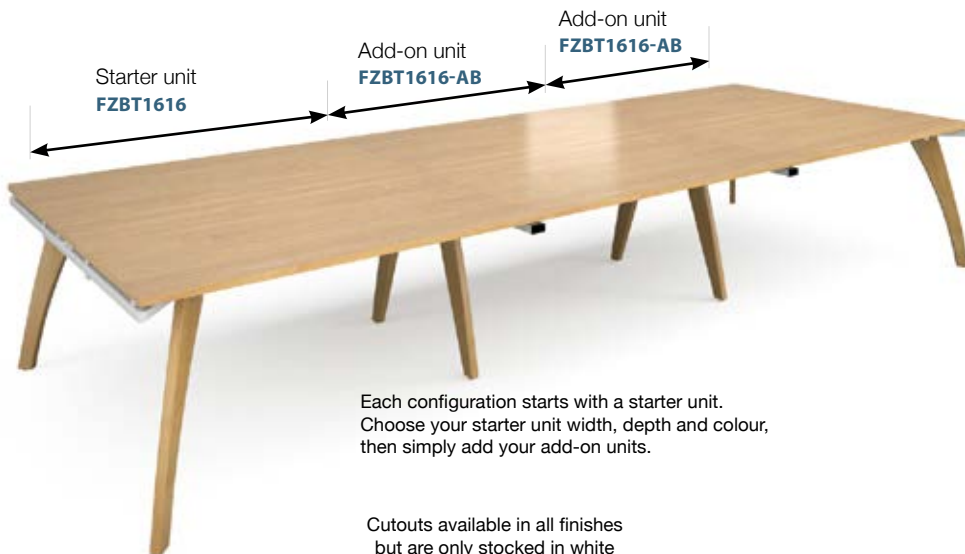

Starter plus Add-on units



Starter leg moves to the end



Fully assembled units



FRAMES



White
(WH)

STOCKED



White
(WH)



Grey Oak
(GO)



Light Grey
(LG)



Black
(BK)



Onyx Grey
(OG)



Kendal Oak
(KO)

MTO - 3 WEEKS LEAD TIME

Please add frame finish followed by table top colour when ordering eg. **FZBT1616** with White frame in White/Oak = **FZBT1616-WH-WO**

ARROW HEAD

PANEL BASED TABLE RANGE

Simply designed to ensure core functionality, Arrow Head offers versatile tables in a variety of shapes and finishes to suit any boardroom or meeting setting. The Arrow Head leg design offers rigidity and strength with its clean cut lines and balanced proportions. Single tables can be used individually for meetings, or several tables can be grouped together to achieve various room layouts.



Product warranty



Designed & manufactured



Stocked finishes

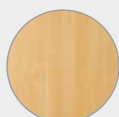

Beech



White

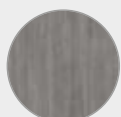

Grey Oak

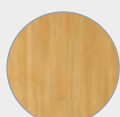

Oak

Made-to-Order finishes



Light Grey



Black

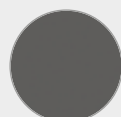

Onyx Grey

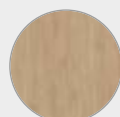

Kendal Oak

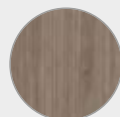

Barcelona Walnut

Arrow Head | Panel Bases

Rectangular Boardroom Tables



CODE	W	D	H	STOCKED	MTO
EB18	1800	1000	725	£611	£620
EB20	2000	1000	725	£653	£660
EB18-CO	1800	1000	725	£611	£615
EB20-CO	2000	1000	725	£653	£660



-CO with 132mm x 272mm cutout
Cutouts stocked in White

- Rectangular boardroom table with 25mm tops & impact resistant ABS edging
- Additional modular extensions enable a variety of configurations

Boat Shape Boardroom Table



CODE	W	D	H	STOCKED	MTO
ERB24	2400	800-1300	725	£873	£897

- Radial boardroom table with 25mm tops & impact resistant ABS edging
- Boat shaped table top available in a choice of five wood finishes

Radial End Boardroom Table



CODE	W	D	H	STOCKED	MTO
EB24	2400	1000	725	£839	£850
EB24-CO	2400	1000	725	£839	£850



-CO with 132mm x 272mm cutout
Cutouts stocked in White

- Radial end boardroom table with 25mm tops & impact resistant ABS edging
- Curved table top with arrow head panel legs and adjustable foot levellers

Circular Meeting Table



CODE	W	D	H	STOCKED	MTO
RT12	1200	1200	725	£352	£362

- Circular meeting table with 25mm tops & impact resistant ABS edging
- Free standing table with cruciform legs

Radial Extension Table



CODE	W	D	H	STOCKED	MTO
EB10D	1000	1000	725	£351	£355

- Radial boardroom extension table with 25mm tops & ABS edging
- To be used together with the rectangular boardroom table and square extensions

Square Extension Table



CODE	W	D	H	STOCKED	MTO
EB10	1000	1000	725	£315	£355

- Square boardroom extension table with 25mm tops & ABS edging
- To be used together with the rectangular boardroom table and radial extensions

Cutouts available in all finishes but are only stocked in white

STOCKED

MTO - 3 WEEKS LEAD TIME



Beech (B)



White (WH)



Grey Oak (GO)



Oak (O)



Light Grey (LG)



Black (BK)



Onyx Grey (OG)



Kendal Oak (KO)



Barcelona Walnut (BW)

TRUMPET BASE

CENTRAL PEDESTAL BASED TABLES

Our trumpet base tables are a modern solution for any boardroom featuring a robust, weighted circular base available in silver, white or chrome that offers the ultimate in strength and durability. Curved and straight table tops are available in a choice of five colour finishes to present your company in the best possible way, whether the need calls for impromptu meetings or creative collaboration.



Product warranty



Designed & manufactured



Frame finishes

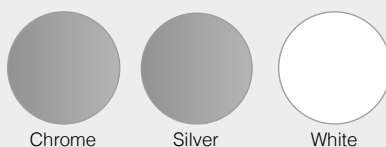

Chrome

Silver

White

Stocked finishes



Beech

Oak

White

Grey Oak

Made-to-Order finishes

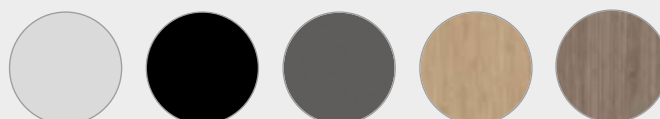

Light Grey

Black

Onyx Grey

Kendal Oak

Barcelona Walnut

Trumpet Base | Central Bases

Rectangular Boardroom Tables



CODE	W	D	H	STOCKED	MTO
TB18	1800	1000	725	£876	£897
TB20	2000	1000	725	£919	£940
TB18-CO	1800	1000	725	£876	£897
TB20-CO	2000	1000	725	£919	£940



-CO with 132mm x 272mm cutout
Cutouts stocked in White

- Rectangular tables 1000mm with 25mm tops & impact resistant ABS edging
- Additional modular extensions enable a variety of configurations

Radial End Boardroom Table



CODE	W	D	H	STOCKED	MTO
TB24	2400	1000	725	£1193	£1228
TB24-CO	2400	1000	725	£1193	£1228



-CO with 132mm x 272mm cutout
Cutouts stocked in White

- Radial end table 1000mm with 25mm tops & impact resistant ABS edging
- Curved table top with steel trumpet base weighted for stability

Circular Boardroom Table



CODE	W	D	H	STOCKED	MTO
TB10C	1000	1000	725	£588	£609

- Circular tables with 25mm tops & impact resistant ABS edging
- Free standing table 1000mm with 680mm diameter, weighted trumpet base

Circular Boardroom Table



CODE	W	D	H	STOCKED	MTO
TB12C	1200	1200	725	£646	£663

- Circular tables with 25mm tops & impact resistant ABS edging
- Free standing table 1200mm with 680mm diameter, weighted trumpet base

Radial Extension Table



CODE	W	D	H	STOCKED	MTO
TB10D	1000	1000	725	£492	£502

- Radial end extension table with 25mm tops & impact resistant ABS edging
- To be used together with the rectangular boardroom table and square extensions

Square Extension Table



CODE	W	D	H	STOCKED	MTO
TB10	1000	1000	725	£492	£470

- Square extension table 1000mm with 25mm tops & impact resistant ABS edging
- Can be used as a stand alone table or as a table extension

Cutouts available in all finishes but are only stocked in white

FRAMES



STOCKED



MTO - 3 WEEKS LEAD TIME



Please add frame finish followed by table top colour when ordering eg. **TB10** with Silver frame in Oak = **TB10-S-O**

ETERNAL

CENTRAL PEDESTAL BASED TABLES

Eternal is a sophisticated boardroom table collection with robust customisable options for all your meeting room needs. Many sizes, shapes, and details let you tailor the look for formal or casual settings, with stylish flat circular bases and cylindrical columns, tops available in five finishes, and integrated power options which makes Eternal a practical choice for supporting technology.



Base finishes

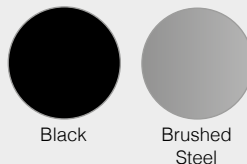

Stocked finishes

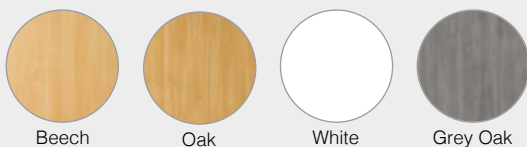

Made-to-Order finishes

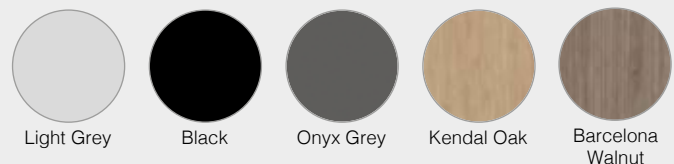

Eternal | Central Bases

Rectangular Boardroom Tables



CODE	W	D	H	STOCKED	MTO
ETN18	1800	1000	725	£871	£897
ETN20	2000	1000	725	£919	£918
ETN18-CO	1800	1000	725	£817	£897
ETN20-CO	2000	1000	725	£919	£918

-CO with 132mm x 272mm cutout
Cutouts stocked in White

- Rectangular tables 1000mm with 25mm tops & impact resistant ABS edging
- Additional modular extensions enable a variety of configurations

Radial End Boardroom Tables



CODE	W	D	H	STOCKED	MTO
ETN24	2400	1000	725	£1152	£1228
ETN24-CO	2400	1000	725	£1152	£1228

-CO with 132mm x 272mm cutout
Cutouts stocked in White

- Radial end table 1000mm with 25mm tops & impact resistant ABS edging
- Curved table top with flat circular bases weighted for stability

Circular Boardroom Tables



CODE	W	D	H	STOCKED	MTO
ETN10C	1000	1000	725	£588	£609
ETN10C-CO	1000	1000	725	£711	£727

-CO with 80mm diameter cutout
Cutouts stocked in White

- Circular tables with 25mm tops & impact resistant ABS edging
- Free standing table 1000mm with flat circular 680mm diameter base

Circular Boardroom Tables



CODE	W	D	H	STOCKED	MTO
ETN12C	1200	1200	725	£652	£668
ETN12C-CO	1200	1200	725	£770	£790

-CO with 80mm diameter cutout
Cutouts stocked in White

- Circular tables with 25mm tops & impact resistant ABS edging
- Free standing table 1200mm with flat circular 680mm diameter base

Radial Extension Table



CODE	W	D	H	STOCKED	MTO
ETN10D	1000	1000	725	£492	£510

- Radial end extension table with 25mm tops & impact resistant ABS edging
- To be used together with the rectangular boardroom table and square extensions

Square Extension Tables



CODE	W	D	H	STOCKED	MTO
ETN10	1000	1000	725	£455	£481
ETN10-CO	1000	1000	725	£577	£599

-CO with 80mm diameter cutout
Cutouts stocked in White

- Square extension table 1000mm with 25mm tops & ABS edging
- Can be used as a stand alone table or as a table extension

Cutouts available in all finishes but are only stocked in white

FRAMES

STOCKED

MTO - 3 WEEKS LEAD TIME



Please add frame finish followed by table top colour when ordering eg. ETN18 with Black frame in Grey Oak = ETN18-K-GO

RADIAL LEG

CONTRACT LEGGED BASE TABLES

Radial leg tables are defined by clean lines and a simple leg design which provide a place to gather, an area to create, or a spot to focus. Simplistic yet robust, the round tubular screw in legs, available in chrome, silver, black and white, complement the 25mm table tops to suit any intended space, with a variety of configurations to meet the demands of any user group.



Leg finishes

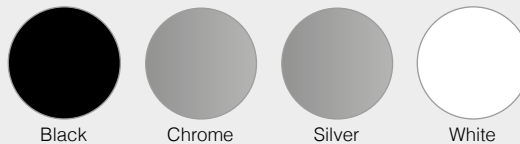

Stacked finishes



Radial Leg | Contract Legged Base

Radial End Tables



CODE	DESCRIPTION	W	D	H	RRP
DRL2400	Radial End	2400	1000	725	£527

- Available in nine top finishes, including timbers and plains

Circular Tables



CODE	DESCRIPTION	W	D	H	RRP
DRL1200C	Circular	1200	1200	725	£442

- Circular tables in two sizes 1000 & 1200mm diameter

Circular Table



CODE	DESCRIPTION	W	D	H	RRP
DRL1000C	Circular	1000	1000	725	£413

- Radial 60mm diameter legs available in 4 finishes

LEGS

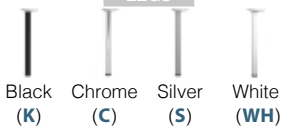

STOCKED



Please add leg finish followed by table top colour when ordering eg. **DRL2400** with Black legs in Oak = **DRL2400-K-O**

ANSON

EXECUTIVE LEGGED BASE TABLES

The boardroom is an integral part of any office and it's the room where it all happens and the Anson range of boardroom tables provide attendees with the distinctive impression of quality, precision & strength that makes a bold, visual statement in any conference room. Create the right impression for customers, employees, important business contacts, interviewees, and showcase the business in the best possible way with Anson tables.



Stocked finish

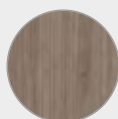

Barcelona
Walnut

Made-to-Order finishes



Light Grey



Black

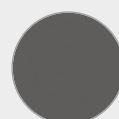

Onyx Grey

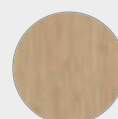

Kendal Oak

Anson | Executive Legged Base

Circular Tables



CODE	DESCRIPTION	W	D	H	RRP
ANS-TBC12	Circular	1200	1200	725	£1300

- Clean lines and an elegant, sleek design
- Supports executive, managerial meeting or boardrooms

Square Tables



CODE	DESCRIPTION	W	D	H	RRP
ANS-TBS12	Square	1200	1200	725	£1300

- Offer a versatile whole room solution
- Choice of matching storage options

Rectangular Table



CODE	DESCRIPTION	W	D	H	RRP
ANS-TBR22	Rectangular	2200	1200	725	£1500

- Two-tone designer leg frames
- Easy clean surfaces that are scratch resistant



Light Grey
(LG)



Black
(BK)



Onyx Grey
(OG)



Kendal Oak
(KO)



Barcelona Walnut
(BW)

Please add table top colour when ordering eg. **ANS-TBS12** in Barcelona Walnut = **ANS-TBS12-BW**



MODULAR

ADAPTABLE TABLE SYSTEMS



DELUXE FLIPTOP

228



CONTRACT FLIPTOP

230



STRAIGHT FOLDING LEG

232



CURVED FOLDING LEG

234



RADIAL LEG

236



FLEXI 25

238



TVLOCK

237

DELUXE FLIPTOP

PREMIUM NESTING & TILTING TABLES



Product warranty



Designed & manufactured

Our deluxe fliptop tables allow you to create dynamic spaces for people to easily meet and collaborate. The full tilting underframe and user friendly, pivoted release mechanism ensures a smooth, controlled flipping action, with heavy duty castors that lock securely into place when tables are in use, and allow for easy manoeuvrability when the fliptop tables are nested together for convenient storage.



Frame finishes



Black



Silver



White

Finishes

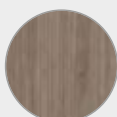

Barcelona
Walnut



Beech

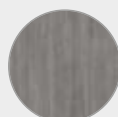

Grey Oak

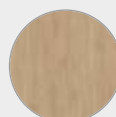

Kendal Oak

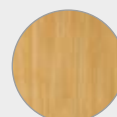

Oak



White



Light Grey



Black

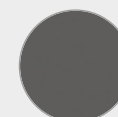

Onyx Grey

Deluxe Fliptop | Nesting & Tilting Underframe

Rectangular Deluxe Fliptop Tables



CODE	W	D	H	RRP
DFLP12	1200	800	725	£768
DFLP14	1400	800	725	£782
DFLP16	1600	800	725	£827

- Rectangular tables 800mm deep with a folding table top for easy storage
- Fliptop to manoeuvre between tight spaces and nest together

Semi-Circular Deluxe Fliptop Table



Example layouts

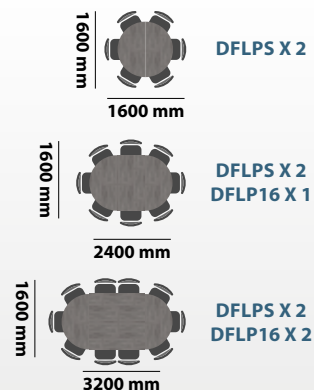

CODE	W	D	H	RRP
DFLPS	1600	800	725	£865

- Semi-circular tables 800mm deep with a tilting frame for easy storage
- Modular tables for multiple configurations with lockable castors

Nesting Deluxe Fliptop Tables



215mm gap in between tables when nested together

FRAMES



Black
(K)

Silver
(S)

White
(WH)

STOCKED



Barcelona
Walnut (BW)

Beech
(B)

Grey Oak
(GO)

Kendal Oak
(KO)

Oak
(O)

White
(WH)

Light Grey
(LG)

Black
(BK)

Onyx Grey
(OG)

Please add frame finish followed by table top colour when ordering eg. **DFLP16** with White frame in Grey Oak = **DFLP16-WH-GO**

CONTRACT FLIPTOP

NESTING & TILTING TABLES



Product warranty



Designed & manufactured

Fliptop tables are an excellent choice for conference, office, meeting and training facilities with the ability to quickly and easily configure a room. Incorporating a simple, thumb wheel release mechanism, the fliptop table frames provide a reliable, cost-effective and space saving solution within all workplace environments. Then you can simply fold down and roll away until needed again.



Frame finish



Silver

Finishes

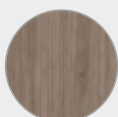

Barcelona
Walnut



Beech

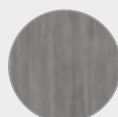

Grey Oak

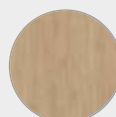

Kendal Oak

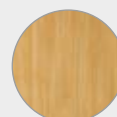

Oak



White



Light Grey



Black

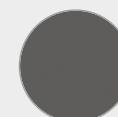

Onyx Grey

Contract Fliptop | Nesting & Tilting Underframe

Rectangular Fliptop Tables



CODE	W	D	H	RRP
FLP12	1200	800	725	£447
FLP14	1400	800	725	£462
FLP16	1600	800	725	£492

- Rectangular tables 800mm deep with a folding table top for easy storage
- Fliptop to manoeuvre between tight spaces and nest together

Semi-Circular Fliptop Table



Example layouts

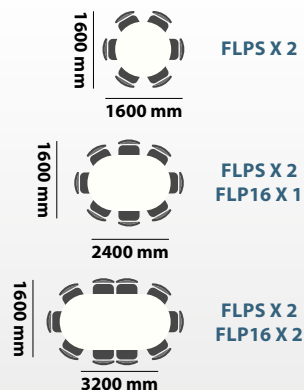

CODE	W	D	H	RRP
FLPS	1600	800	725	£509

- Semi-circular tables 800mm deep with a tilting frame for easy storage
- Modular tables for multiple configurations with lockable castors

Fliptop Tilting Underframe



215mm gap in between tables when nested together

FRAME



Silver
(S)



Barcelona
Walnut **(BW)**



Beech
(B)



Grey Oak
(GO)



Kendal Oak
(KO)



Oak
(O)



White
(WH)



Light Grey
(LG)



Black
(BK)



Onyx Grey
(OG)

STOCKED

Please add frame finish followed by table top colour when ordering eg. **FLP16** with Silver frame in White = **FLP16-S-WH**

STRAIGHT LEG

FOLDING UNDERFRAME TABLES

Straight folding leg tables combine simplistic good looks with versatility and are ideal for use in meeting rooms, conference suites and exhibitions. A click button mechanism on the underside of the table means the folding frame, available in different finish options, can be folded neatly within the footprint of the table top, offering easy manoeuvrability and convenient storage.



Product warranty



Designed & manufactured



Frame finishes

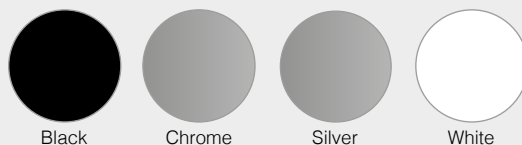

Black

Chrome

Silver

White

Finishes

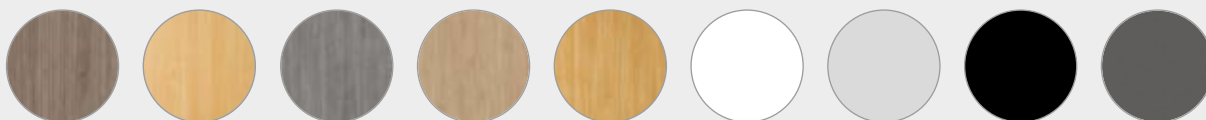

Barcelona
Walnut

Beech

Grey Oak

Kendal Oak

Oak

White

Light Grey

Black

Onyx Grey

Straight Leg | Folding Underframe

Rectangular Folding Leg Tables



CODE	W	D	H	RRP
SFL1200	1200	800	725	£456
SFL1400	1400	800	725	£471
SFL1600	1600	800	725	£490
SFL1800	1800	800	725	£550

- Rectangular tables 800mm deep with folding tubular legs
- Folding frame for easy handling and storage when not in use

Semi-Circular Folding Leg Table



Example layouts

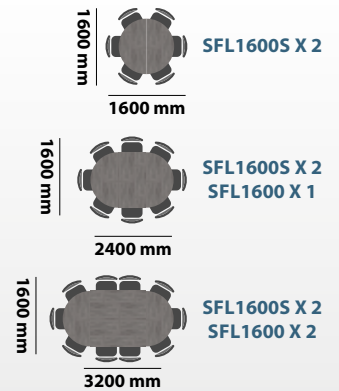

CODE	W	D	H	RRP
SFL1600S	1600	800	725	£549

- Semi-circular tables 800mm deep with folding tubular straight frame
- Modular tables for multiple configurations with steel frame and legs

Straight Folding Legs Storage



STACKING HEIGHT

125mm per table
Stack up to 12 high (1.5m)



FRAMES



Black (K) Chrome (C) Silver (S) White (WH)

STOCKED



Barcelona Walnut (BW) Beech (B) Grey Oak (GO) Kendal Oak (KO) Oak (O) White (WH) Light Grey (LG) Black (BK) Onyx Grey (OG)

Please add frame finish followed by table top colour when ordering eg. **SFL1600** with Black frame in Grey Oak = **SFL1600-K-GO**

CURVED LEG

FOLDING UNDERFRAME TABLES

Curved folding leg tables combine stylish good looks with versatility and are ideal for use in meeting rooms, conference suites and exhibitions. When folded, the tables stack together neatly for easy storage. The frame design also offers sufficient leg room for users when sat around the tables, and can be used stand-alone or together with the rectangular and semi-circular tables to create your layout.



Frame finishes

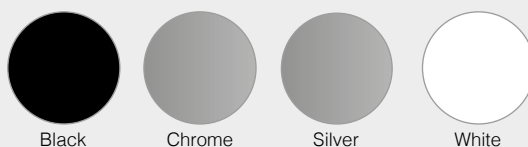

Black

Chrome

Silver

White

Finishes

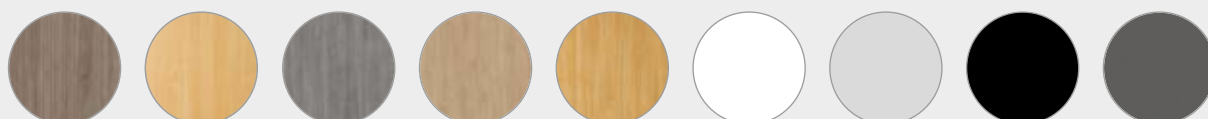

Barcelona
Walnut

Beech

Grey Oak

Kendal Oak

Oak

White

Light Grey

Black

Onyx Grey

Curved Leg | Folding Underframe

Rectangular Folding Leg Tables



CODE	W	D	H	RRP
CFL1200	1200	800	725	£456
CFL1400	1400	800	725	£471
CFL1600	1600	800	725	£490
CFL1800	1800	800	725	£549

- Rectangular tables 800mm deep with folding tubular curved frame
- Folding frame for easy handling and storage when not in use

Semi-Circular Folding Leg Table



Example layouts



CODE	W	D	H	RRP
CFL1600S	1600	800	725	£549

- Semi-circular tables 800mm deep with folding tubular curved frame
- Modular tables for multiple configurations with steel frame and legs

Curved Folding Leg Mechanism



FRAMES

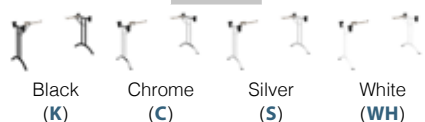

STOCKED



Please add frame finish followed by table top colour when ordering eg. **CFL1600** with White frame in Oak = **CFL1600-WH-O**

RADIAL LEG

CONTRACT LEGGED BASE TABLES

Radial leg tables are defined by clean lines and a simple leg design which provide a place to gather, an area to create, or a spot to focus. Simplistic yet robust, the round tubular screw in legs, available in chrome, silver, black and white, complement the 25mm table tops to suit any intended space, with a variety of configurations to meet the demands of any user group.



Leg finishes

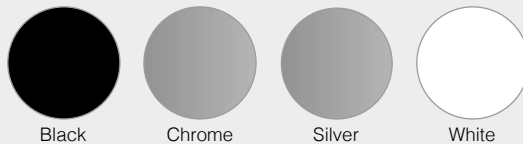

Black

Chrome

Silver

White

Finishes

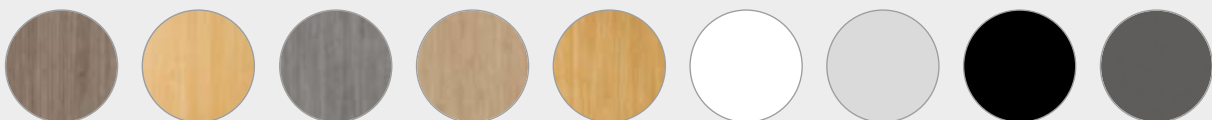

Barcelona
Walnut

Beech

Grey Oak

Kendal Oak

Oak

White

Light Grey

Black

Onyx Grey

Radial Leg | Contract Legged Base

Straight Radial Leg Tables



CODE	W	D	H	RRP
DRL800	800	800	725	£322
DRL1200	1200	800	725	£332
DRL1400	1400	800	725	£352
DRL1600	1600	800	725	£376
DRL1800	1800	800	725	£436

- Straight tables 800mm deep with radial legs
- Deluxe radial legs which screw into the table tops to suit any meeting space

Semi-Circular Radial Leg Table



Example layouts



CODE	W	D	H	RRP
DRL1600S	1600	800	725	£436

- Semi-circular tables 800mm deep with radial screw-in legs
- Modular tables for multiple configurations with 60mm diameter legs

Linking Lock



CODE	DESCRIPTION	RRP
TVLOCK	Table link	£43

- Easy to fit table top linking mechanism with a quick release mechanism
- Use when creating table configurations to ensure the table tops are level
- Can be used with fliptop, folding leg and radial leg tables
- Linking device for use with meeting table configurations

LEGS

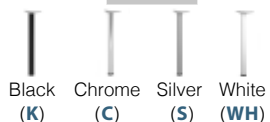

STOCKED



Please add leg finish followed by table top colour when ordering eg. **DRL1600** with Black legs in Barcelona Walnut = **DRL1600-K-BW**

FLEXI 25

SLIM LEGGED BASE TABLES

Our flexible meeting table solutions are suitable for a wide range of applications to cater for all of your office needs. Offering complete mobility and functionality, our Flexi tables are solid, reliable and built to last. Available in a wide range of sizes, 25mm table top finishes and with a choice of silver or graphite powder coated steel frames, Flexi tables can be used in multiple combinations for all styles of meetings.



Product warranty



Designed & manufactured



Frame finishes

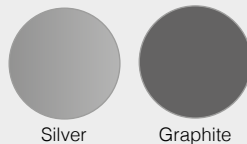

Silver

Graphite

Finishes

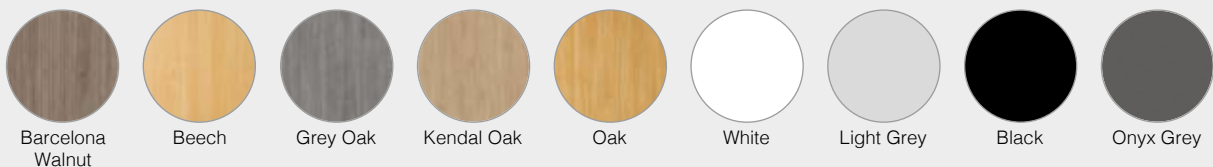

Barcelona
Walnut

Beech

Grey Oak

Kendal Oak

Oak

White

Light Grey

Black

Onyx Grey

FLEXI 25 | Contract Legged Base

Silver Leg Flexi-Tables



CODE	W	D	H	RRP
FLT800-S	800	800	725	£181
FLT1200-S	1200	800	725	£192
FLT1400-S	1400	800	725	£210
FLT1600-S	1600	800	725	£225
FLT1800-S	1800	800	725	£242

- 800mm deep tables with silver frame supplied flat packed
- Spiral stacking option for easy, convenient storage

Graphite Leg Flexi-Tables



CODE	W	D	H	RRP
FLT800-G	800	800	725	£181
FLT1200-G	1200	800	725	£192
FLT1400-G	1400	800	725	£210
FLT1600-G	1600	800	725	£225
FLT1800-G	1800	800	725	£242

- 800mm deep tables with graphite frame supplied flat packed
- Spiral stacking option for easy, convenient storage

Spiral Stacking



STACKING HEIGHT
Offset stacking up to 8 high
(1125mm high)

FRAMES

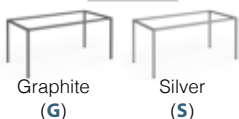

Graphite
(G)

Silver
(S)

STOCKED



Barcelona
Walnut (BW)

Beech
(B)

Grey Oak
(GO)

Kendal Oak
(KO)

Oak
(O)

White
(WH)

Light Grey
(LG)

Black
(BK)

Onyx Grey
(OG)

Please add frame finish followed by table top colour when ordering eg. **FLT1600-S** with Silver frame in Oak = **FLT1600-S-O**



CAFE & DINING

MULTI HEIGHT TABLE COLLECTION



MONZA
242



BRESCIA
246



EROS
248



PISA
250



GENOA
252



ROMA
254

MONZA

CIRCULAR PEDESTAL BASE TABLES

Classic, contemporary and refined are the words most often used to describe the Monza range. Tables are available in coffee and poseur table formats as well as standard height meeting or dining tables. With its slim profile base and tubular column, Monza has a timeless design that never goes out of style, and the choice of circular, square or rectangular tops allows for customisation of design and function.



Base finishes

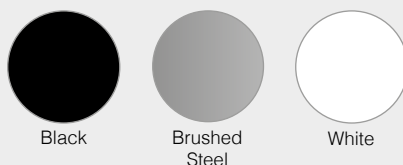

Black

Brushed
Steel

White

Finishes

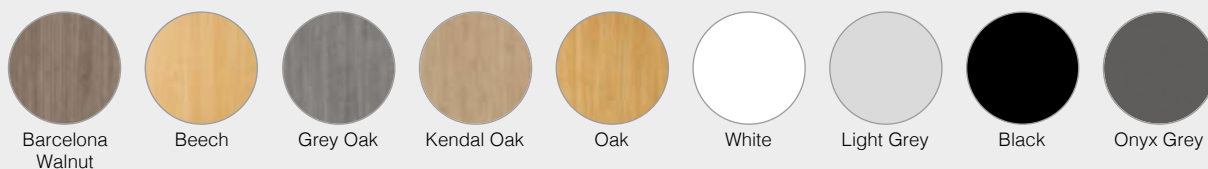

Barcelona
Walnut

Beech

Grey Oak

Kendal Oak

Oak

White

Light Grey

Black

Onyx Grey

Monza | Coffee, Dining & Poseur Tables

Circular Tables with Flat Round Base

CODE	DESCRIPTION	W	D	H	RRP
MCC800	Coffee	800	800	490	£376
MDC800	Dining	800	800	725	£376
MPC800	Poseur	800	800	1110	£447

- Circular tables with 25mm table top
- Single column with flat round base



Square Tables with Flat Round Base

CODE	DESCRIPTION	W	D	H	RRP
MCS800	Coffee	800	800	490	£376
MDS800	Dining	800	800	725	£428
MPS800	Poseur	800	800	1110	£560

- Square table with 25mm table top
- Single column with flat round base



Rectangular Tables with Flat Round Bases

CODE	W	D	H	RRP
MPR1200	1200	800	1110	£773
MPR1400	1400	800	1110	£805
MPR1600	1600	800	1110	£835
MPR1800	1800	800	1110	£863

CODE	W	D	H	RRP
MDR1200	1200	800	725	£687
MDR1400	1400	800	725	£716
MDR1600	1600	800	725	£745
MDR1800	1800	800	725	£773

CODE	W	D	H	RRP
MCR1200	1200	800	490	£657
MCR1400	1400	800	490	£687
MCR1600	1600	800	490	£716
MCR1800	1800	800	490	£745

- Rectangular poseur table with 25mm table top
- Double column with flat round base



Please add base finish followed by table top colour when ordering eg. **MDR1600** with White base in Kendal Oak = **MDR1600-WH-KO**

MONZA POWER

INTEGRATED PEDESTAL BASE TABLES



Product warranty



Designed & manufactured

Furniture and equipment that allows quick set-up and connections is a high priority so people can pick up where they left off in another working area. Table tops with circular cutouts are designed to incorporate power and data capabilities to transform office canteens and dining spaces, where employees can take their laptops, tablets and phones with them for a more connected, advanced working environment.



Base finish



Brushed Steel

Finishes

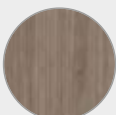

Barcelona Walnut

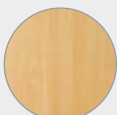

Beech

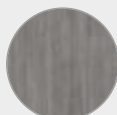

Grey Oak

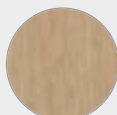

Kendal Oak

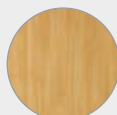

Oak



White



Light Grey



Black

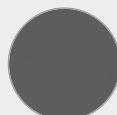

Onyx Grey

Monza Power Ready | Coffee, Dining & Poseur Tables

Circular Tables with Cutouts

CODE	DESCRIPTION	W	D	H	RRP	MTO
MCC800-CO	Coffee	800	800	480	£486	£785
MDC800-CO	Dining	800	800	725	£486	£897
MPC800-CO	Poseur	800	800	1110	£574	£1009

- Circular 800mm table with 80mm central cutout for power modules
- Single column with flat round base



Power Modules



Please note:
Mains lead to be
ordered separately

CODE	DESCRIPTION	W	D	H	RRP
ION-1-K	Black	100	100	2	£78
ION-1-WH	White	100	100	2	£78

- Ultra-compact Ion power unit to fit in 80mm table cutout
- 1 x UK socket, 1 x USB Charger (type A)

STOCKED

STOCKED

MTO



Brushed Steel (**BS**)



White (**W**)



Barcelona Walnut (**BW**)



Beech (**B**)



Grey Oak (**GO**)



Kendal Oak (**KO**)



Oak (**O**)



Light Grey (**LG**)



Black (**BK**)



Onyx Grey (**OG**)

Please add base finish followed by table top colour when ordering eg. **MCC800-CO** with Brushed Steel base in Beech = **MCC800-CO-BS-B**

BRESCIA

SQUARE PEDESTAL BASE TABLES

The Brescia collection of tables features simple, contemporary lines and its expansive product offering supports virtually any workplace environment. Brescia tables are offered in a variety of sizes, shapes and heights. Supporting the 25mm table tops, available in 6 finishes, is a matching central column and slim square base which wouldn't look out of place in any modern workplace.



Base finishes



Black



Brushed Steel



White

Finishes

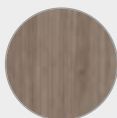

Barcelona Walnut

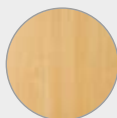

Beech

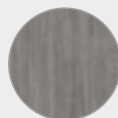

Grey Oak

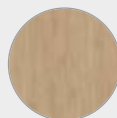

Kendal Oak

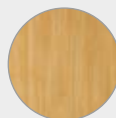

Oak



White



Light Grey



Black

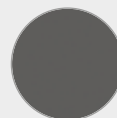

Onyx Grey

Circular Tables with Flat Square Base



CODE	DESCRIPTION	W	D	H	RRP
BCC800	Coffee	800	800	490	£360
BDC800	Dining	800	800	725	£360
BPC800	Poseur	800	800	1110	£432

- Circular tables with 25mm table top
- Single column with flat square base

Square Tables with Flat Square Base



CODE	DESCRIPTION	W	D	H	RRP
BCS800	Coffee	800	800	490	£360
BDS800	Dining	800	800	725	£408
BPS800	Poseur	800	800	1110	£538

- Square table with 25mm table top
- Single column with flat square base

Rectangular Tables with Flat Square Bases

CODE	W	D	H	RRP
BPR1200	1200	800	1110	£744
BPR1400	1400	800	1110	£771
BPR1600	1600	800	1110	£800
BPR1800	1800	800	1110	£827

CODE	W	D	H	RRP
BDR1200	1200	800	725	£658
BDR1400	1400	800	725	£687
BDR1600	1600	800	725	£716
BDR1800	1800	800	725	£744

CODE	W	D	H	RRP
BCR1200	1200	800	490	£629
BCR1400	1400	800	490	£658
BCR1600	1600	800	490	£687
BCR1800	1800	800	490	£716

- Rectangular tables with 25mm table top
- Double column with flat square base



BASES



Black
(K)



Brushed Steel
(BS)



White
(WH)



Barcelona
Walnut (BW)



Beech
(B)



Grey Oak
(GO)



Kendal Oak
(KO)



Oak
(O)



White
(WH)



Light Grey
(LG)



Black
(BK)



Onyx Grey
(OG)

STOCKED

Please add base finish followed by table top colour when ordering eg. **BDR1600** with Brushed Steel base in Barcelona Walnut = **BDR1600-BS-BW**

EROS

TWIN PEDESTAL BASE TABLES

Eros tables have the right proportions, flawless surfaces and a solid foundation, featuring a sturdy, rectangular base and twin uprights available in black, brushed steel and white that offer the ultimate in strength and stability. Eros has a simple yet stylish design which can be used as a dining table or as a meeting table in any traditional or modern breakout space or dining area.



Base finishes

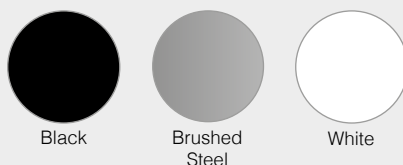

Black

Brushed
Steel

White

Finishes

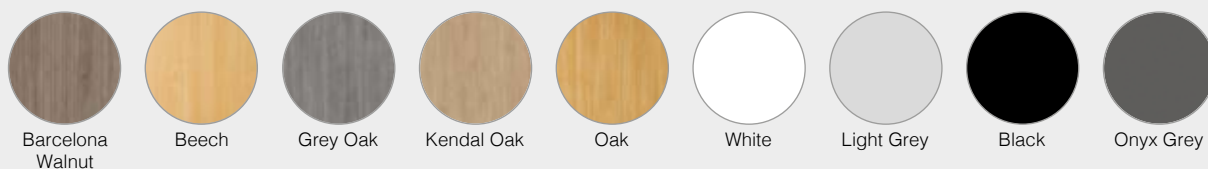

Barcelona
Walnut

Beech

Grey Oak

Kendal Oak

Oak

White

Light Grey

Black

Onyx Grey

Eros | Coffee, Dining & Poseur Tables

Rectangular Coffee Table with Flat Rectangular Base



CODE	W	D	H	RRP
ECR1200	1200	800	490	£629
ECR1400	1400	800	490	£658
ECR1600	1600	800	490	£687

- Rectangular coffee table with two square columns and flat rectangular base
- Ideal for use with soft seating in an informal waiting area

Rectangular Dining Table with Flat Rectangular Base



CODE	W	D	H	RRP
EDR1200	1200	800	725	£658
EDR1400	1400	800	725	£687
EDR1600	1600	800	725	£716

- Rectangular dining table with two square columns and flat rectangular base
- Suitable for use as a dining or meeting table

Rectangular Poseur Table with Flat Rectangular Base



CODE	W	D	H	RRP
EPR1200	1200	800	1100	£744
EPR1400	1400	800	1100	£771
EPR1600	1600	800	1100	£800

- Rectangular poseur table with two square columns and flat rectangular base
- High table ideal for use in canteen environments

BASES



Black
(K)

Brushed Steel
(BS)

White
(WH)

STOCKED



Barcelona Walnut
(BW)

Beech
(B)

Grey Oak
(GO)

Kendal Oak
(KO)

Oak
(O)

White
(WH)

Light Grey
(LG)

Black
(BK)

Onyx Grey
(OG)

Please add base finish followed by table top colour when ordering eg. **EDR1200** with Black base in Grey Oak = **EDR1200-K-GO**

PISA

CHROME PEDESTAL BASE TABLES

The Pisa tables range has been designed to bring people together, inspiring conversation and collaboration. Designed to complement virtually any décor, the polished chrome circular base and column supports a 25mm table top available in a variety of sizes and finishes, as well as dining, poseur and coffee table heights, making it perfect for canteens, cafes, lounges, receptions - anywhere people gather.



Product warranty



Designed & manufactured



Base finish



Chrome

Finishes

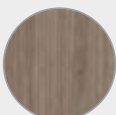

Barcelona
Walnut

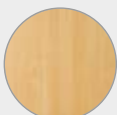

Beech

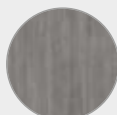

Grey Oak

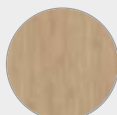

Kendal Oak

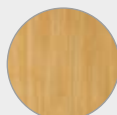

Oak



White



Light Grey



Black

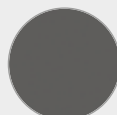

Onyx Grey

Circular Tables with Round Base

CODE	DESCRIPTION	W	D	H	RRP
PCC800	Coffee	800	800	490	£380
PDC800	Dining	800	800	725	£383
PPC800	Poseur	800	800	1110	£458

- Circular tables with 25mm table top
- Single chrome column with radial base



Square Tables with Round Base

CODE	DESCRIPTION	W	D	H	RRP
PCS800	Coffee	800	800	490	£383
PDS800	Dining	800	800	725	£428
PPS800	Poseur	800	800	1110	£560

- Square tables with 25mm table top
- Single chrome column with radial base



Rectangular Tables with Round Bases

CODE	W	D	H	RRP
PPR1200	1200	800	1110	£773
PPR1400	1400	800	1110	£805
PPR1600	1600	800	1110	£835
PPR1800	1800	800	1110	£863

CODE	W	D	H	RRP
PDR1200	1200	800	725	£595
PDR1400	1400	800	725	£634
PDR1600	1600	800	725	£652
PDR1800	1800	800	725	£669

CODE	W	D	H	RRP
PCR1200	1200	800	490	£597
PCR1400	1400	800	490	£597
PCR1600	1600	800	490	£667
PCR1800	1800	800	490	£667

- Rectangular tables with 25mm table top
- Double upright columns with radial base



STOCKED



Chrome
(C)



Barcelona
Walnut (BW)



Beech
(B)



Grey Oak
(GO)



Kendal Oak
(KO)



Oak
(O)



White
(WH)



Light Grey
(LG)



Black
(BK)



Onyx Grey
(OG)

Please add base finish followed by table top colour when ordering eg. **PDR1600** with Chrome base in White = **PDR1600-WH**

GENOA

TRUMPET PEDESTAL BASE TABLES

Genoa dining tables have the right proportions, flawless surfaces and a solid foundation, featuring a trumpet base available in silver, white or chrome that offers the ultimate in strength and stability. Curved and straight table tops are available in a choice of 6 colour finishes, with a simple yet stylish design which can be used as a dining table or as a meeting table in any traditional or modern breakout dining area.



Base finishes

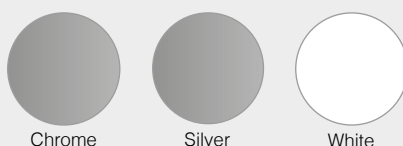

Chrome

Silver

White

Finishes

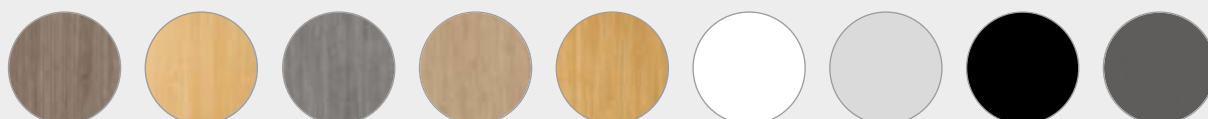

Barcelona
Walnut

Beech

Grey Oak

Kendal Oak

Oak

White

Light Grey

Black

Onyx Grey

Genoa | Coffee & Dining Tables

Circular Tables with Trumpet Base



CODE	W	D	H	RRP
GDC800	800	800	725	£376

- Circular tables with 25mm table top
- Single chrome column with radial base

Square Tables with Trumpet Base



CODE	W	D	H	RRP
GDS800	800	800	725	£428

- Square tables with 25mm table top
- Single chrome column with radial base

Rectangular Tables with Trumpet Bases



CODE	W	D	H	RRP
GDR1200	1200	800	725	£687
GDR1400	1400	800	725	£716
GDR1600	1600	800	725	£745
GDR1800	1800	800	725	£773

- Rectangular tables with 25mm table top
- Double upright columns with radial base

BASES



Please add base finish followed by table top colour when ordering eg. **GDS800** with Silver base in Beech = **GDS800-S-B**

ROMA

LEGGED PEDESTAL BASE TABLES

Comprising of an incredibly sturdy and reliable aluminium table base, Roma dining tables are just as suitable for the office canteen as the cafeteria. A stable legged base in chrome enables seating to tuck in effortlessly and the base of the table has adjustable feet that allow you to prevent any wobbling on uneven floors. It is also versatile in its simplicity, making it suitable for many different applications.



Base finish



Chrome

Finishes

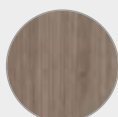

Barcelona
Walnut



Beech

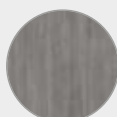

Grey Oak

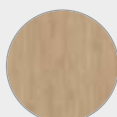

Kendal Oak

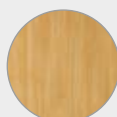

Oak



White



Light Grey



Black



Onyx Grey

Roma | Dining Tables

Circular Tables



CODE	W	D	H	RRP
RDC800	800	800	725	£367

Square Tables



CODE	W	D	H	RRP
RDS800	800	800	725	£367

STOCKED



Please add table top colour when ordering eg. **RDS800** in Oak = **RDS800-O**

A modern office lounge area with a woman sitting on a sofa, talking on a phone. The room features large windows, a mezzanine level with a glass railing, and contemporary furniture including a round coffee table and a side table. The entire image is overlaid with a blue tint.

COFFEE & SIDE

MAKE AN IMPACT



TURIN
258



SIANO
259



PARMA
260



ESTE
261



ESTE
262



BUDDY
263

Turin | Tube Frame



The Turin Executive Table is a versatile and sophisticated choice for any commercial space. Its tubular minimalistic frame is a sturdy addition to any breakout or reception area. Anthracite powder coated frames combined with Alaska rustic timber top provides a contemporary aesthetic appearance.



TUR1200

TUS500

Features jointed tubular frame with Slimline 18mm MFC tops with 2mm robust matching ABS edging

Sleek and low rectangular 1200mm wide and 600mm deep coffee standing at the ideal height of 400mm

Matching square 500mm wide and 500mm deep side table at a taller versatile height of 600mm

Versatile and sophisticated choice, delivered complete with no assembly required

CODE	DESCRIPTION	W	D	H	RRP
TUS500	Square Table	500	500	600	£190
TUR1200	Rectangular Table	1200	600	400	£275



STOCKED



Black Frame

Alaska

Fully welded frame and supplied assembled

Siano | Square Frame



COFFEE & SIDE

A striking x-shaped square profiled frame design truly sets Siano apart from the rest. In addition to enhancing the coffee table's durability and stability, the distinctive black powder-coated frame with black marble aesthetic top draws the eye yet retains a stylish, elegant presence.



SIS800



SIS450

Slimline square profiled frame with corresponding 18mm MFC tops with 2mm robust matching ABS edging

Two table variations, low coffee table 800mm square at 400mm high and taller side table 450mm square at 555mm high

With its accommodating size and eye-catching design, the Siena coffee table range is sure to spark conversation

The sturdy composition of the table is primed to withstand the demands of any dynamic workspace

CODE	DESCRIPTION	W	D	H	RRP
SIS800	Low Table	800	800	400	£275
SIS450	High Table	450	450	555	£190



STOCKED



Black Frame



Lotus

Fully welded frame and supplied assembled

Parma | Square Frame



PAR1100



PAS500

Function and form intersect to create high visual interest in the Parma Coffee Table. The sides of the tabletop are raised, forming a distinctive tray style design and adding an element of control. The Parma is ideal for any dynamic, high-traffic interior to keep things in place, regardless of type of workplace environment.

Gold colour powder coated square profiled frame. Fully welded for durability and stability

Low and sleek rectangular 1100mm wide and 500mm deep coffee standing at the perfect height of 418mm

Venus oak 18mm MFC tops and sides with 2mm robust matching ABS edging

The functional tray style top of the table ensure your items and papers are kept in place, at arm's reach

CODE	DESCRIPTION	W	D	H	RRP
PAS500	Square Table	500	500	545	£190
PAR1100	Rectangular Table	1100	500	418	£275



STOCKED



Gold Frame

Venus

Fully welded frame and supplied assembled



Este delivers an avant-garde aesthetic to any commercial space. Designed with a ring of vertical bars, the frame of this coffee table create visual interest, while functionally providing further stability and durability. The Este range of tables is sure to delight in any breakout space, reception, or anywhere people gather.



Round bar black powder coated frame with contrasting white marble style 18mm MFC tops

Circular table in 2 variations, low and high
High displayed here

Striking yet refined, the delicate, ornate lines of the table's frame provide a luxurious decorative factor

A touch of elegance remains stable and sturdy for use in any commercial or high-traffic interior

CODE	DESCRIPTION	W	D	H	RRP
ESC450	Circular Table	450	450	540	£300



STOCKED



Black Frame



Carrara

Fully welded frame and supplied assembled

Este | Tube Frame



Este delivers an avant-garde aesthetic to any commercial space. Designed with a ring of vertical bars, the frame of this coffee table create visual interest, while functionally providing further stability and durability. The Este range of tables is sure to delight in any breakout space, reception, or anywhere people gather.



Round bar black powder coated frame with contrasting white marble style 18mm MFC tops

Circular table in 2 variations, low and high
Low displayed here

Striking yet refined, the delicate, ornate lines of the table's frame provide a luxurious decorative factor

A touch of elegance remains stable and sturdy for use in any commercial or high-traffic interior

CODE	DESCRIPTION	W	D	H	RRP
ESC800	Circular Table	800	800	450	£380



STOCKED



Black Frame Carrara

Fully welded frame and supplied assembled

Buddy | Square Frame



COFFEE & SIDE

Buddy tables blend materials and simple shapes for sophisticated designs that serve as stylish focal points in breakout spaces. These versatile, practical tables provide comfortable working positions for using devices while seated in lounge chairs or sofas.

Laptop tables provide support with a weighted stable base and elegant column

Fashionable, flexible and highly functional with choice of black or white frames

Ideal for use with soft seating to work away from desk for a break

MFC tops with matching edge available in Kendal Oak or White



BUDDY-1-K



BUDDY-2-WH

CODE	DESCRIPTION	W	D	H	RRP
BUDDY-1-K	Black frame	460	500	680	£325
BUDDY-1-WH	White frame	460	500	680	£325
BUDDY-2-K	Black frame	300	500	675	£259
BUDDY-2-WH	White frame	300	500	675	£259



STOCKED



Kendal Oak (KO)



White (WH)



Kendal Oak (KO)



White (WH)

Please add frame finish followed by table top colour when ordering eg. **BUDDY-1** with Black frame in Kendal Oak = **BUDDY-1-K-KO**



RECEPTION DESKS

CREATE AN IMPRESSION

COMPACT RECEPTION UNITS



WELCOME
266

MODULAR RECEPTION UNITS



DENVER
268



DENVER PRE-CONFIGURED
270



Designed &
manufactured

Welcome | Reception Units



First impressions matter, and the Welcome reception desk provides a crucial, contemporary impression. With an integrated table and counter top available in white or beech, it creates the foundations for a stunning reception area for any hospitality or workplace setting.



Reception unit 1130mm overall high with desktop and combined counter unit

White carcass with full length modesty panel and choice of beech or white tops

Create a clean and uncluttered reception desk solution with add-on accessories available

Ample room at the front of the desk to add your company logo or graphics



CODE	W	D	H	RRP
WRD14	1462	890	1130	£760
WRD16	1662	890	1130	£831



White/Beech (B)



White (WH)

Please add desk finish when ordering eg. **WRD16** in White/Beech = **WRD16-B**



60 LED lights



IP65 Rating

Ideal for creating a welcoming space, the Welcome desk is available with an optional D-end extension for extra workspace and accessibility. The remote-controlled LED lighting can be paired with personalised graphics on the front panel, helping to align with corporate identity.



Universal left hand or right hand extension table with silver steel support leg

Create a commanding reception feature to give greater access and additional work space

Self-adhesive and easy to fit LED lighting strip that can be retro fitted to desk

Remote control lighting with the press of a button to light up the reception area

DESK RETURN

CODE	W	D	H	RRP
WDET	1000	890	725	£243

LED LIGHT

CODE	DESCRIPTION	RRP
WLIGHT	2m strip	£337



Beech (B)



White (WH)

Please add desk finish when ordering eg. **WDET** in Beech = **WDET-B**



The Denver modular reception desk, available in beech with optional white panels, offers flexible configurations to create a lasting first impression. Its thoughtful design creates a commanding reception feature, helping to set the tone of the company's values. Choice of 3 straight & 2 curved bases.



RUHC18D

RU12D

RU8D

RUC8D

High quality, front office reception desk base units with straight and curved options

Robust units with 2mm ABS edging and cable access ports that align with the hutch units

Available in beech and beech with white panels with surfaces that are scratch and heat resistant

Create multiple desk configurations where many important tasks are carried out



• Inside view

STRAIGHT BASES

CODE	W	D	H	DESCRIPTION	RRP
RU8D	800	800	742	Straight	£354
RU12D	1200	800	742	Straight	£438
RU16D	1600	800	742	Straight	£486

CURVED BASES

CODE	W	D	H	DESCRIPTION	RRP
RUHC18D	1800	800	742	45 degree curve	£658
RUC8D	800	800	742	Corner	£443



Beech (B)



Beech/White (BWH)

Please add unit colour when ordering eg. RU12D in Beech = RU12D-B



Denver modular units combine base sections and counter tops with glass shelves to create bespoke reception desks to suit any space, with adequate storage ensuring a professional and uncluttered appearance. The choice of four straight tops and three curved tops, including glass shelves.



Hutch units can be fitted above base units to create linear configurations

Robust units with 2mm ABS edging and cable access ports that align with the desktops

Curved hutch units to be fitted above corner base units to create curved configurations

Glass shelves can be added to provide a more executive look and feel to the area



• Inside view

STRAIGHT TOPS

CODE	W	D	H	DESCRIPTION	RRP
RU8H	800	350	430	Straight	£224
RU12H	1200	350	430	Straight	£236
RU16H	1600	350	430	Straight	£307
RU8GS-S	790	340	150	Glass straight	£230

CURVED TOPS

CODE	W	D	H	DESCRIPTION	RRP
RUHC8H	915	350	430	45 degree	£453
RUC8H	800	800	430	Corner	£350
RU8GS-C	910	340	150	Glass curved	£246



Beech (B)



Beech/White (BWH)

Please add unit colour when ordering eg. **RU12H** in Beech = **RU12H-B**

Denver | Pre-Configured

Denver Medium Straight Reception Unit



• Inside view

CONTAINS

- 1 x **RU8GS-S** - Straight glass shelf 790mm
- 1 x **RU8H** - Straight top unit 800mm
- 1 x **RU16D** - Straight base unit 1600mm

CODE	W	D	H	RRP
DVB01	1600	800	1172	£940

Denver Medium Curved Reception Unit



• Inside view

CONTAINS

- 1 x **RUHC8H** - 45° curved top unit 915mm
- 1 x **RU8GS-C** - Curved glass shelf 910mm
- 1 x **RUHC18D** - 45° curved base unit 1800mm

CODE	W	D	H	RRP
DVB02	1800	800	1172	£1357

Denver Extra Large U-Shaped Reception Unit

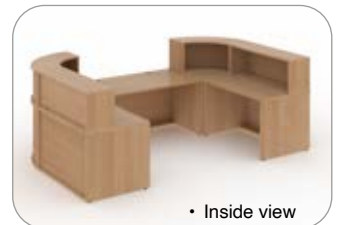

• Inside view

CONTAINS

- 2 x **RUC8H** - Corner top unit 800mm
- 2 x **RU12H** - Straight top unit 1200mm
- 2 x **RUC8D** - 90° corner base unit 800mm
- 2 x **RU12D** - Straight base unit 1200mm
- 1 x **RU16D** - Straight base unit 1600mm

CODE	W	D	H	RRP
DVB03	3200	2000	1172	£3420



Beech (B)



Beech/White (BWH)

Please add unit colour when ordering eg. **DVB01** in Beech = **DVB01-B**

Denver | Pre-Configured

Denver Extra Large Curved Reception Unit

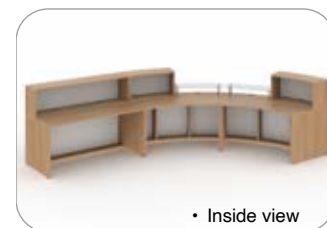
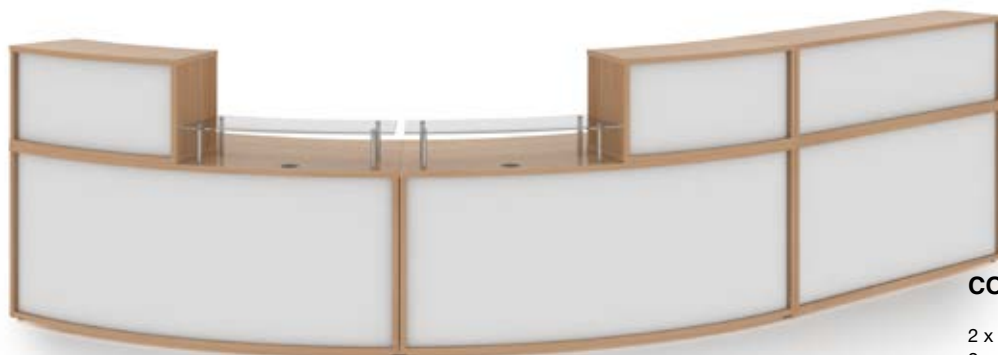

CONTAINS

- 2 x **RU8GS-C** - Curved glass shelf 790mm
- 2 x **RUHC8H** - 45° curved top unit 800mm
- 1 x **RU16H** - Straight top unit 1600mm
- 1 x **RU16D** - Straight base unit 1600mm
- 2 x **RUHC18D** - 45° curved base unit 1800mm

CODE	W	D	H	RRP
DVB04	3552	2352	1172	£3507

Denver Large Curved Reception Unit



CONTAINS

- 2 x **RUC8H** - Corner top unit 800mm
- 2 x **RUC8D** - Corner base unit 800mm
- 1 x **RUHC18D** - 45° curved base unit 1800mm

CODE	W	D	H	RRP
DVB05	2788	1224	1172	£2244

Denver Large Straight Reception Unit

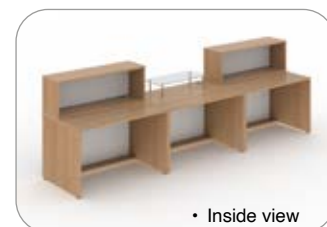

CONTAINS

- 1 x **RU8GS-S** - Straight glass shelf 790mm
- 2 x **RU12H** - Straight top unit 1200mm
- 3 x **RU12D** - Straight base unit 1200mm

CODE	W	D	H	RRP
DVB06	3600	800	1172	£2016



Beech (B)



Beech/White (BWH)

Please add unit colour when ordering eg. **DVB04** in Beech/White = **DVB04-BWH**

STOCKED RANGES

“Over 270 seating products in stock and available for immediate express delivery”



MTO RANGES

*“Manufactured and upholstered to specification,
from unlimited number of fabrics. A solution for
all aspects of the workplace”*

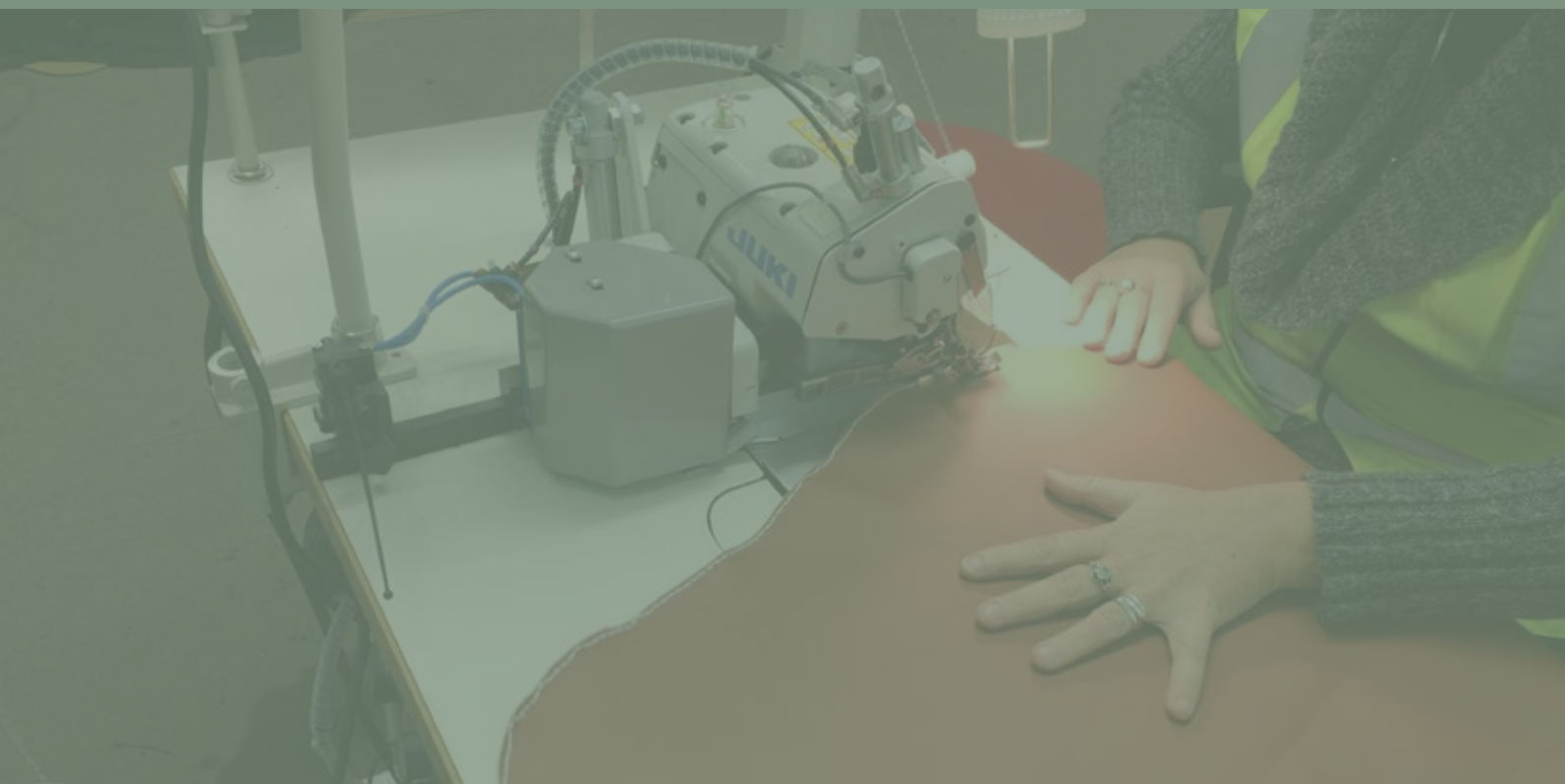

Are you sitting comfortably?

Selecting the right office chair does not have to be complicated. The key points to remember when choosing office chairs are, how long are the chairs are being used for and what activity will the user be doing while using the chair.

Head rest

Comfort and support option for performance chairs

Back rest

Allow the spinal column to follow the natural 'S' shape

Lumbar support

Adjusts to support the lower back and spine

Arm rests

Provide support for the upper body and therefore reduce the stress on the users shoulders and back

Seat height

Allow for your feet to be firmly on the floor when seated. The seat height should be just below the knee cap when standing

Chair base

5 star base to support the chair with weight loaded castors

Castors

To allow the chair to move freely on all surfaces



Setting up your workstation

The first step in setting up an office chair is to establish the desired height of the individual's desk or workstation. This decision is determined primarily by the type of work to be done and by the height of the person using the office chair.

✓ Correct Posture



1. Head

Keep your head upright and over your shoulder

2. Eyes

Look slightly downward (30° range from horizontal line of sight) without bending from the neck

3. Back

Your back should be supported by the backrest of the chair that promotes the natural curve of the spine

4. Arms

Elbows should be bent at 90°, forearms horizontal. Shoulders should be relaxed but not depressed

5. Legs

Thighs horizontal with a 90° -110° angle at the hip

6. Feet

Keep your feet fully supported on the floor. If this isn't possible, then the feet should be fully supported by a footrest

✗ Incorrect Posture



Chair Features & Benefits

The application of ergonomics in your workplace will make the environment more comfortable for all employees, boosting productivity and reducing stress – something that serves both the employer and employees alike.

Tilting



Knee tilt adjustment

Seat and back move backwards in tandem, lockable in various positions.

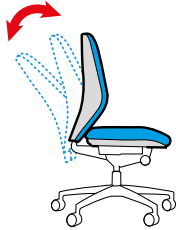

Standard tilt lock

Seat and back move backwards in tandem, lockable in upright position only.



Locking tilt lock

Seat and back move backwards in tandem, lockable in any position.



Independent seat tilt

Allows the seat to be independently tilted forwards and backwards.



Tilt rocker

Allows the back to be independently tilted forwards and backwards.



Synchro seat & back tilt

Seat and back move in a synchronised motion. Lockable in multiple positions.



Mechanisms



Gas lift adjustment

Raises and lowers the height of the seat to fit the user.



Back height adjustment

Allows the seat back to be higher and lowered to suit.



Back rake adjustment

Independent back tilt control. Lockable in multiple positions.



Weight tension control

Adjustable to the users weight for controlled smooth reclining action.



Seat depth adjustment

Seat slides forwards and backwards to match the users size.



Back Support

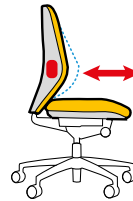

Lumbar support

Offers additional support to the lower back.

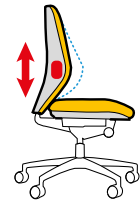

Adjustable lumbar support

Manual lumbar adjustment to support the back where needed.

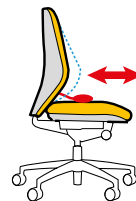

Adjustable Lumbar pump

Adjust the back position easily with pump action to support the back.

Arms



Fixed loop

Loop arms fixed in position to provide support for the body.



Height adjustable

Arms adjust in height. Lockable in multiple positions.



Pivot

Arms can be pivoted back and forth for clear access.



Adjustable folding

Arms adjust in height and can be folded back when not required.



Adjustable 3D

Arms adjust in height, front & back, and left & right positions.



Adjustable 4D

Arms adjust in height, front & back, and left & right positions in addition to moving in and out to suit.



Writing tablet

Arm comes complete with a writing tablet which can be adjusted for writing or reading or put down.

STOCKED SEATING

PERFORMANCE TRIPLE P



8 RANGES
282

TASK MESH



15 RANGES
286

OPERATOR MESH



16 RANGES
296

FABRIC TASK



14 RANGES
306

EXECUTIVE SEATING



21 RANGES
316

MEETING CHAIRS



11 RANGES
328

MULTIPURPOSE



CHAIRS & STOOLS
336

SOFT SEATING



LOUNGE & BOOTH
348

A woman with long dark hair tied back is sitting in a modern, high-back office chair. She is looking towards the left, smiling slightly. In front of her is a desk with a computer monitor. The monitor displays a software interface with various controls and a search bar. The entire image is overlaid with a semi-transparent orange filter. The text 'TRIPLE P CHAIRS' is prominently displayed in the center, with 'PERFORMANCE SEATING' below it.

TRIPLE P CHAIRS

PERFORMANCE SEATING



ELISE
282



LYRA
282



SHELBY GREY
283



SHELBY BLACK
283



HOLDEN
284



KARA
284



PAXTON
285



SWAY
285



Elise



Remarkable for style, comfort, and support, the Elise performance task chair has a breathable, supple all-mesh seat and back to promote a more comfortable and productive work day, with a built-in lumbar mechanism that offers enhanced comfort and an integrated headrest for constant support.



Overall width **680**
 Overall depth **700**
 Overall height **1140-1280**
 Seat width **505**
 Seat depth **420-480**
 Seat height **460-550**
 Back width **515**
 Back height **600-650**
 Arm height from floor **660-910**

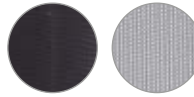

Black mesh seat with black mesh back

Code **EL5300K2-K** **Arm type** 3D adjustable arms **RRP** **£826**



- Back height adjustment
- Gas lift adjustment
- Weight tension control
- Seat depth adjustment
- Synchro seat & back tilt
- Adjustable lumbar support
- 3D adjustable arms



Lyra



The adjustable functionality of Lyra allows its user to approach comfort from any angle. Enhanced adjustability is granted to the headrest, arms, and lumbar support, for both height and angle, too. Lyra's is a standout chair, ergonomically designed synchronised mesh seat and back ensures the user feels supported.



Overall width **700**
 Overall depth **680**
 Overall height **1095-1325**
 Seat width **510**
 Seat depth **505**
 Seat height **465-545**
 Back width **510**
 Back height **710-750**
 Arm height from floor **615-765**

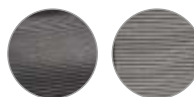

Black mesh seat with black mesh back

Code **LYR300T1-K** **Arm type** 4D arms **RRP** **£800**



- Back height adjustment
- Gas lift adjustment
- Seat depth adjustment
- Synchro seat & back tilt
- Adjustable lumbar support
- Adjustable lumbar pump
- 4D adjustable arms



Shelby Grey

Inspired by the bridge pose of yoga, the Shelby Bifma certified ergonomic chair ingeniously embraces a 3D dynamic dual-back to relieve the pressure felt by your lumbar region, and help you maintain the right sitting posture for long hours, preventing back-related issues.

Overall width **685**
 Overall depth **700**
 Overall height **990-1080**
 (Headrest **1150-1240**)
 Seat width **510**
 Seat depth **520**
 Seat height **460-550**
 Back width **490**
 Back height **600** (Headrest **800**)
 Arm height from floor **670-840**



Code	Description	Arms	RRP
SHL300K2-G	No headrest	3D Adjustable	£625
SHL301K2-G	With headrest	3D Adjustable	£675

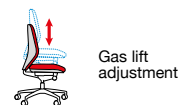

Gas lift adjustment



Seat depth adjustment



Synchro seat & back tilt



Adjustable lumbar support



Adjustable lumbar support



3D adjustable arms



Shelby Black

Inspired by the bridge pose of yoga, the Shelby Bifma certified ergonomic chair ingeniously embraces a 3D dynamic dual-back to relieve the pressure felt by your lumbar region, and help you maintain the right sitting posture for long hours, preventing back-related issues.

Overall width **685**
 Overall depth **700**
 Overall height **990-1080**
 (Headrest **1150-1240**)
 Seat width **510**
 Seat depth **520**
 Seat height **460-550**
 Back width **490**
 Back height **600** (Headrest **800**)
 Arm height from floor **670-840**

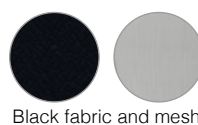

Code	Description	Arms	RRP
SHL300K2-K	No headrest	3D Adjustable	£625
SHL301K2-K	With headrest	3D Adjustable	£675



Gas lift adjustment



Seat depth adjustment



Synchro seat & back tilt



Adjustable lumbar support



Adjustable lumbar support



3D adjustable arms



5
WARRANTY
YEARS

110
KG

Holden

The smooth tilting mechanism can be locked into a reclined position. The gas lift and reclining mechanism are integrated into the seat allowing for easy ergonomic access. The 4-dimensional arms can move in all directions. A height adjustable rear lumbar support and head rest finish off the styling and user comfort.

Overall width **690**
Overall depth **620**
Overall height **1250-1330**
Seat width **480**
Seat depth **500**
Seat height **440-520**
Back width **440**
Back height **590**
Arm height from floor **610-770**



Black fabric seat with black mesh back

Code	Description	RRP
HOL300T1-K	4D adjustable arms	£573



Gas lift adjustment



Synchro seat & back tilt



Adjustable lumbar support



4D adjustable arms

5
WARRANTY
YEARS

135
KG

Kara

Kara's design can be summarised in one word: dynamic. From top to bottom, Kara's features are adjustable, designed for movement and fluidity for customised comfort. Kara features a mesh back for temperature control, and is available in black, grey, or green. Soft pad armrest, are adjustable optimum arm support.

Overall width **650**
Overall depth **660**
Overall height **1190-1260**
Seat width **500**
Seat depth **445**
Seat height **470-540**
Back width **500**
Back height **720**
Arm height from floor **535-710**

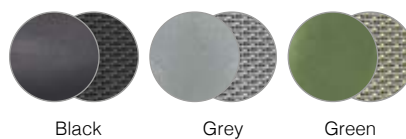

Black

Grey

Green

Code	Description	Arms	RRP
KAR300T1-K	Black	3D arms	£550
KAR300T1-G	Grey	3D arms	£550
KAR300T1-GN	Green	3D arms	£550



Back height adjustment



Gas lift adjustment



Weight tension control



Seat depth adjustment



Synchro seat & back tilt



Adjustable lumbar support



3D adjustable arms



Paxton

110 KG

The base is a stylish aluminium finish which is complemented by the styling of the back and integrated 3 dimensional arms. The seat slide allows personalised seat depth adjustment where required and with the height, recline and seat depth adjustments all integrated into the seat they are ergonomically accessible.



Overall width 650
Overall depth 580
Overall height 1010-1090
Seat width 500
Seat depth 480
Seat height 410-490
Back width 420
Back height 610
Arm height from floor 620-750

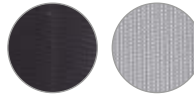

Black air mesh seat with black mesh back

Code **Arm type** **RRP**
PAX300T1-K 3D adjustable arms **£530**



Gas lift adjustment



Seat depth adjustment



Synchro seat & back tilt



Adjustable lumbar support



3D adjustable arms



Sway

154 KG

The Sway operator chair provides harmony between form and function. Sway is all about encouraging movement, with a unique dynamic mechanism that allows for side-to-side movement, which helps users with twisting into unnatural positions to grab something just out of reach.



Overall width 690
Overall depth 600
Overall height 1045-1125
Seat width 500
Seat depth 500
Seat height 460-540
Back width 435
Back height 675
Arm height from floor 640-790

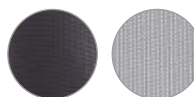

Black fabric seat with black mesh back

Code **Description** **RRP**
SWY300K2-G 3D adjustable arms **£492**



Gas lift adjustment



Synchro seat & back tilt



3D adjustable arms

A modern mesh task chair is the central focus of the image. It features a high-back design with a mesh backrest and a matching mesh headrest. The chair has adjustable armrests, a five-point chrome base with casters, and a central column with adjustment knobs. The chair is positioned in an office environment, with a desk and keyboard visible on the left and a window in the background. The entire image is overlaid with a semi-transparent orange filter.

MESH TASK CHAIRS

COMFORT AND STYLE FOR
PRODUCTIVE WORKSPACES



GEMIN
288



YASMIN
289



SANDRO
289



SIRENA
290



CURVA
290



NAPIER
291



ZALA
291



RONAN
292



DIONE
293



ARCADE
292



SENZA
293



ALTINO - 3 LEVER
294



ALTINO - 2 LEVER
294



JOTA
295



ISLA
295



110 KG

Gemini

Gemini is the perfect chair for those who spend hours sitting at the computer, with adjustable arms and a padded headrest that can be locked in as well as the lumbar support. This stunning office chair can be adjusted to many positions to suit the unique requirements of the user.

EN 1335-1:2000 / EN 1335-2:2009

Overall width **490**
 Overall depth **640**
 Overall height **960-1085**
 Seat width **490**
 Seat depth **480**
 Seat height **480-550**
 Back width **460**
 Back height **530**
 Arm height from floor **650-750**

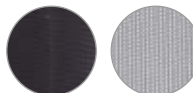

Black air mesh seat with black mesh back

Code	Arm type	RRP
GEM300K2	No arms	£540
GEM301K2	Adjustable arms	£605
GEM302K2	Arms & headrest	£650

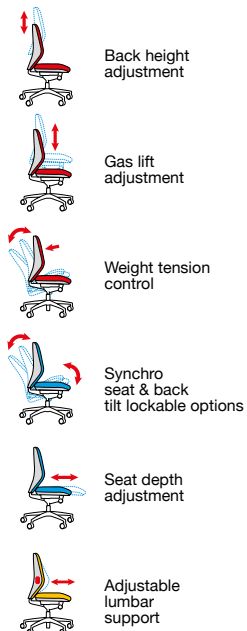



Yasmin



Stylish 5-star base has foot supports and the seat is well proportioned with contoured foam for additional comfort. The mechanism is adjustable and lockable in the reclined position while also having depth adjustment for individual user requirements. The large back has padded adjustable lumbar support.



Overall width **710**
 Overall depth **650**
 Overall height **1000-1090**
 Seat width **550**
 Seat depth **500**
 Seat height **450-540**
 Back width **500**
 Back height **560**
 Arm height from floor **610-790**



Black fabric seat with black mesh back

Code **YAS300T1-K** **Arm type** Adjustable arms **RRP** **£450**

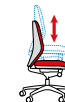

Gas lift adjustment



Synchro seat & back tilt lockable options



Adjustable lumbar support



Sandro



Sandro represents the modern style of mesh seating offering a refinement of function, comfort and style. The air mesh fabric waterfall seat, chrome detailing and stylish mesh back design make it a perfect fit for offices and workstations where users can sit in comfort for long periods.



Overall width **660**
 Overall depth **660**
 Overall height **1235-1335**
 Seat width **520**
 Seat depth **500**
 Seat height **450-550**
 Back width **480**
 Back height **720-780**
 Arm height from floor **660-760**



Black air mesh seat with black mesh back

Code **SND300K2-K** **Arm type** Adjustable arms **RRP** **£440**



Gas lift adjustment



Weight tension control



Synchro seat & back tilt lockable options



Adjustable lumbar support





Sirena



A stylish multi-purpose mesh back one-piece chair. Sirena looks as good in the home office as it does in a boardroom or office. The one-piece mesh back is a modern design classic that is further enhanced with a smooth tilt action.



Overall width 575
 Overall depth 500
 Overall height 1010
 Seat width 500
 Seat depth 450
 Seat height 450-550
 Back width 460
 Back height 480
 Arm height from floor 665-750

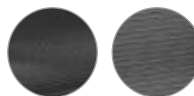

Black air mesh seat with black mesh back



Gas lift adjustment



Knee tilt adjustment

Code	Base type	RRP
SIR305-K-K	Black base	£414
SIR305-C-K	Chrome base	£466



Curva



The Curva high back executive mesh chair has been designed with a sculptured moulded foam seat and breathable mesh back. Aesthetics, form and function are merged seamlessly in the Curva ergonomic executive chair which is ideal for users who sit at a desk for most of the day.



Overall width 630
 Overall depth 690
 Overall height 1100-1175
 Seat width 480
 Seat depth 410
 Seat height 460-535
 Back width 500
 Back height 660
 Arm height from floor 640-715

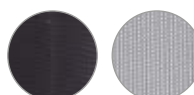

Black air mesh seat with black mesh back

RRP
£418

Code	Arm type
CUR300T1	Pivot arms



Gas lift adjustment



Weight tension control



Back rake adjustment



Pivot arms





Napier

The Napier operator chair provides exceptional back support through the open mesh-back construction and steel frame. The designer mesh seat, pivot arms and padded arm pads offer responsive movement and immediate comfort for collaborative work spaces, and a wide variety of applications.

130 KG



Overall width **650**
 Overall depth **595**
 Overall height **1040-1120**
 Seat width **490**
 Seat depth **500**
 Seat height **500-580**
 Back width **465**
 Back height **580**
 Arm height from floor **690-770**

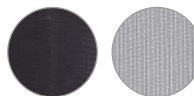

Black air mesh seat with black mesh back

Code
NAP300T1

Arm type
 Pivot arms

RRP
£413

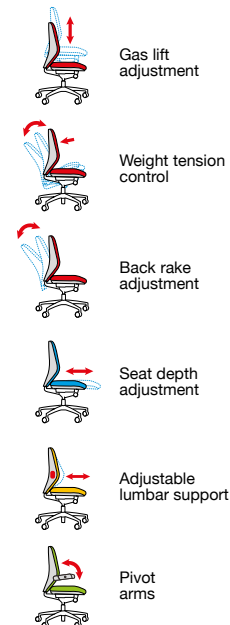

Zala

A well-proportioned mesh seat, back and head rest. The base is manufactured from steel for extra durability and finished a black matt paint to match the mesh. The mechanism is operated using the same lever for both height adjustment and reclining position. Arms adjust in 3 movements for maximum comfort & support.

110 KG



Overall width **680**
 Overall depth **660**
 Overall height **1170-1310**
 Seat width **490**
 Seat depth **430**
 Seat height **460-540**
 Back width **510**
 Back height **480**
 Arm height from floor **640-795**



Black fabric seat with black mesh back

Code
ZAL300T1-K

Arm type
 3D Adjustable arms

RRP
£370

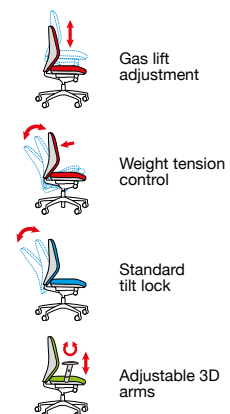



Ronan



The Ronan high mesh back operator chairs are a stylish and practical solution. Available with a black 5 star base Ronan utilises a combination of fabric and breathable mesh in its construction making this chair extremely comfortable for long hours of sitting, especially in the warmer months.



Overall width **630**
 Overall depth **590**
 Overall height **980-1060**
 Seat width **510**
 Seat depth **500**
 Seat height **450-530**
 Back width **480**
 Back height **560**
 Arm height from floor **660-740**

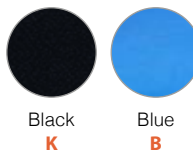

Code
RON300T1 **Arm type**
 Fixed arms **RRP**
 £360

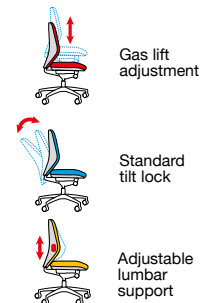

Arcade



The design of the Arcade chair draws inspiration from classical yoga positions to make sitting an enjoyable experience at work. The black mesh back complements the light grey frame perfectly and the adjustable lumbar support keeps the user's back in contact with the back of the chair.



Overall width **635**
 Overall depth **600**
 Overall height **1000-1090**
 Seat width **500**
 Seat depth **500**
 Seat height **460-550**
 Back width **460**
 Back height **560**
 Arm height from floor **705-775**



Code
ARC300T1-G **Arm type**
 Adjustable arms **RRP**
 £345

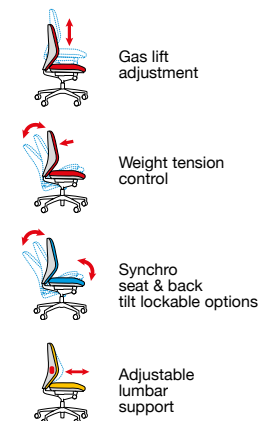



Senza



Comfort, reliability and affordability are the key attributes of the Senza operators chair with its curvaceous profile and vast array of options. Equipped with ergonomic features, a high mesh back and padded fabric seat. This operators chair easily provides the comfort needed for a long day at work. EN 1335-1:2000 / EN 1335-2:2009



Overall width **670**
 Overall depth **650**
 Overall height **970-1100**
 Seat width **520**
 Seat depth **500**
 Seat height **470-600**
 Back width **450**
 Back height **500**
 Arm height from floor **620-750 (SM43), 600-800 (SM44), 470-800 (SM46)**

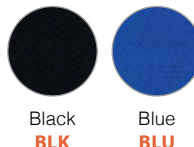

Code	Arm type	RRP
SM40-000	No arms	£320
SM43-000	Fixed arms	£350
SM44-000	Adjustable arms	£385
SM46-000	Folding arms	£410

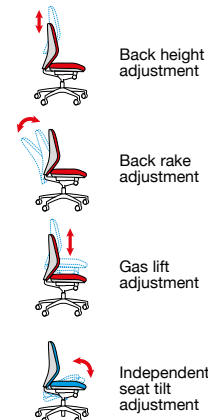

Dione



A standout highly ergonomic chair with a distinctive shape. Dione's supportive mesh high back follows the spine, with a feature integrated headrest. Its multi-functional frame offers adjustability, exceptional comfort with tilt adjustability, three-stage locking, weight tension control & fully adjustable sliding & pivoting armrest



Overall Width **670**
 Overall Depth **640**
 Overall Height **1010-1080**
 Seat width **510**
 Seat depth **450**
 Seat height **440-510**
 Back width **450**
 Back height **670**
 Arm height from floor **640-710**

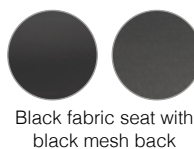

Code	Arm type	RRP
DIO300T1-K	Adjustable arms	£250

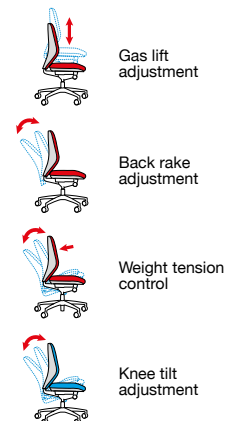



Altino - 3 Lever



At first glance, the signature that marks out the Altino chair is its outline, which is simplified and refined into an integrative and dynamic curve in the lumbar region. Altino integrates a contoured design that ensures consistent support to your back with a seat slide that provides balanced support and movement. EN 1335-1:2000 / EN 1335-2:2009



Overall width **670**
 Overall depth **600**
 Overall height **970-1090**
 Seat width **470**
 Seat depth **450**
 Seat height **440-560**
 Back width **430**
 Back height **530**
 Arm height from floor **600-730 (AH21), 580-780 (AH22)**



Code	Arm type	RRP
AH20-050	No arms	£295
AH21-050	Fixed arms	£315
AH22-050	Adjustable arms	£345

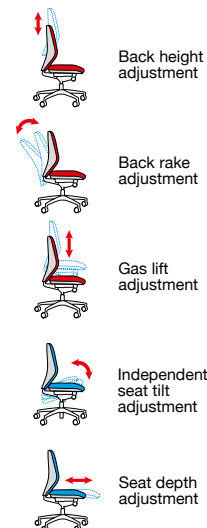

Altino - 2 Lever



With its clean, modern styling, Altino is guaranteed to provide a contemporary feel to any office environment, due to the multi functions and ergonomic design of the chair. The sculptured moulded foam seat combines with the breathable mesh back to keep users cool and comfortable. EN 1335-1:2000 / EN 1335-2:2009



Overall width **670**
 Overall depth **600**
 Overall height **970-1090**
 Seat width **470**
 Seat depth **450**
 Seat height **440-560**
 Back width **430**
 Back height **530**
 Arm height from floor **600-730 (AH11), 580-780 (AH12)**

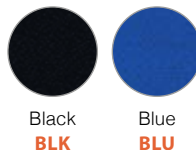

Code	Arm type	RRP
AH10-000	No arms	£210
AH11-000	Fixed arms	£250
AH12-000	Adjustable arms	£277

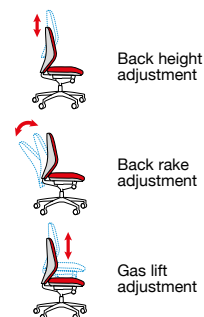



Jota



The Jota Mesh chair has a sleek design, multiple features and allows the user to enjoy the modern design without compromising on good ergonomic support. The Jota Mesh has a breathable, curved mesh back for increased ventilation, complemented by an upholstered seat for added comfort. EN 1335-1:2000 / EN 1335-2:2018



Overall width **670**
 Overall depth **600**
 Overall height **970-1090**
 Seat width **470**
 Seat depth **450**
 Seat height **440-560**
 Back width **430**
 Back height **530**
 Arm height from floor **600-730 (VMH11), 580-780 (VMH12)**

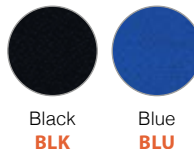

Code	Arm type	RRP
VMH10-000	No arms	£255
VMH11-000	Fixed arms	£275
VMH12-000	Adjustable arms	£300

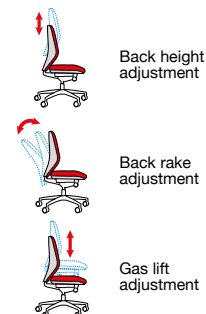

Isla



If you're looking for a heavy duty mesh office chair then look no further than the Isla bariatric chair. Isla adjusts easily to provide supportive seating for people small and large, designed to sit users of up to 27 stone for 24 hours a day while also providing adjustability unlike many other heavy duty chairs.



Overall Width **740**
 Overall Depth **665**
 Overall Height **1010-1100**
 Seat width **585**
 Seat depth **520**
 Seat height **470-560**
 Back width **480**
 Back height **605**
 Arm height from floor **640-780**



Code	Arm type	RRP
ISL300T1-K	Adjustable arms	£500

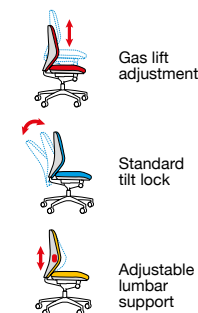



MESH OPERATOR CHAIRS

COMBINES FUNCTION, COMFORT
WITH GREAT VALUE



TRAVIS
298



TUSCAN MESH
298



ORION
299



DUFFY
299



SOLARIS
300



CHORD
300



EVA
301



HALE
301



AURORA
302



JONAS GREY
302



JONAS BLACK
303



TYLER WHITE
303



TYLER BLACK
304



TOTO
304



NINA
305



RHEA
305



Travis



The Travis mesh back operators chair has a sleek design, multiple features and the adjustable lumbar support provides the exact amount of back support customised for each individual user, with cushions that contour naturally around your lower body, and a breathable mesh back to keep you comfortable.



Overall width **640**
 Overall depth **600**
 Overall height **1000-1090**
 Seat width **510**
 Seat depth **510**
 Seat height **450-540**
 Back width **455**
 Back height **575**
 Arm height from floor **635-715**



Grey fabric seat with grey mesh back

Code **TVS300T1-K** **Arm type** Adjustable arms **RRP** **£290**

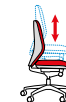

Gas lift adjustment



Weight tension control



Adjustable lumbar support



Tuscan Mesh



The Tuscan chair has a uniquely shaped back and headrest which ensures the chair adapts to the users back and provides just the right amount of comfort and support. Tuscan has ample cushioning whilst retaining a modern pillow design with sleek contours.



Overall width **690**
 Overall depth **600**
 Overall height **1150-1250**
 Seat width **500**
 Seat depth **530**
 Seat height **470-570**
 Back width **470**
 Back height **730**
 Arm height from floor **470-660**

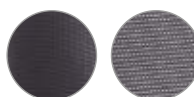

Black fabric seat with black mesh back

Code **TUS300T1** **Arm type** Pivot arms **RRP** **£285**



Gas lift adjustment



Weight tension control



Standard tilt lock



Pivot arms





Orion

The Orion fabric mesh operators chair has been ergonomically designed for healthy seating and wellbeing. Suitable for any work space, Orion has pivot arms and an injection moulded back with mesh upholstery to keep the user well supported and comfortable throughout the day.

115 KG



Overall width **630**
 Overall depth **610**
 Overall height **895-995**
 Seat width **480**
 Seat depth **500**
 Seat height **440-540**
 Back width **470**
 Back height **500**
 Arm height from floor **620-720**

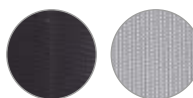

Black fabric seat with black mesh back

Code **ORN300T1-K** **Arm type** Pivot arms **RRP** **£281**

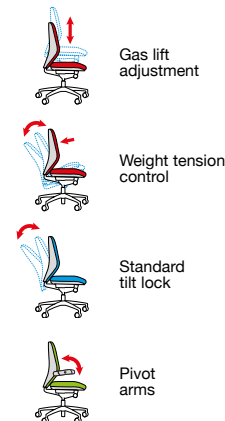

Duffy

Duffy is a well-designed office chair that is proof that ergonomic and affordable are not mutually exclusive. The completely mesh back is ideal for allowing air to flow through the chair, and the Duffy chair with its fixed pointing arms and pleasingly curved back, does well on both these accounts.

115 KG



Overall width **600**
 Overall depth **600**
 Overall height **955-1055**
 Seat width **470**
 Seat depth **550**
 Seat height **450-550**
 Back width **450**
 Back height **520**
 Arm height from floor **640-740**

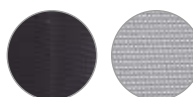

Black air mesh seat with black mesh back

Code **DFY300T1-K** **Arm type** Fixed arms **RRP** **£272**

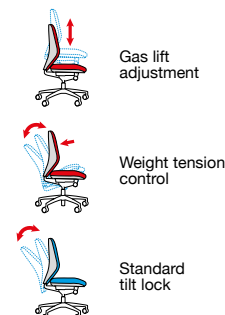



Solaris

115 KG

The Solaris chair has a stylish injection moulded back with breathable mesh and a sculptured lumbar adjustment, which allows the user to sit with optimal comfort and personalised support. Its ergonomic design promotes circulation, to increase energy and improve productivity in the workplace.

Overall width **630**
 Overall depth **610**
 Overall height **1070-1170**
 Seat width **490**
 Seat depth **510**
 Seat height **470-570**
 Back width **500**
 Back height **670**
 Arm height from floor **635-735**

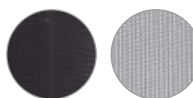

Black fabric seat with black mesh back

Code
SOL300T1-K **Arm type**
 Fixed arms **RRP**
 £272

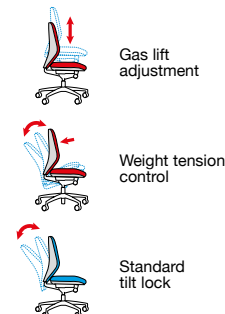

Chord

115 KG

Enjoy the executive style of the ultra-comfy Chord office chair which is the ideal accompaniment to any home office setting. The high back chair has a grey fabric seat and headrest, together with a breathable mesh back to keep you comfortable and cool and ready for the task at hand.

Overall width **610**
 Overall depth **640**
 Overall height **1090-1180**
 Seat width **495**
 Seat depth **490**
 Seat height **450-540**
 Back width **470**
 Back height **740**
 Arm height from floor **670-760**

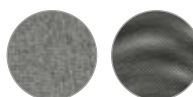

Grey fabric seat with Grey mesh back

Code
CHO300T1-G **Arm type**
 Fixed arms **RRP**
 £256

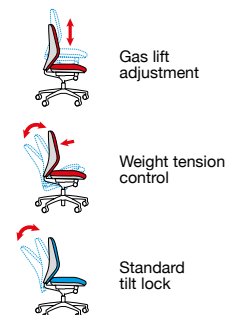



Eva



Eva delivers a splash of vibrant colour to the mesh back task chair range. Available in 4 frame, base, seat upholstery and mesh finishes colour-coordinated for a modern aesthetic. Eva provides independent seat and back tilt, seat height, and weight tension control adjustability, along with fixed sculptured arms.



Overall Width **615**
 Overall Depth **615**
 Overall Height **1040-1135**
 Seat width **510**
 Seat depth **440**
 Seat height **460-555**
 Back width **450**
 Back height **580**
 Arm height from floor **627-722**



Black mesh back
 Grey mesh back
 Orange mesh back
 Blue mesh back



Gas lift adjustment



Weight tension control



Standard tilt lock

Code	Description	Arm type	RRP
EVA300T1-K	Black	Fixed arms	£250
EVA300T1-G	Grey	Fixed arms	£250
EVA300T1-OR	Orange	Fixed arms	£250
EVA300T1-BL	Blue	Fixed arms	£250



Hale



The Hale mesh back operator chair is perfect for someone who is looking for an office chair with all the important basic features, and at a reasonable price. This chair allows you to adjust for height and seat angle with simple controls, as well as tilt-back control, to make you as comfortable as possible.



Overall width **700**
 Overall depth **550**
 Overall height **985-1085**
 Seat width **500**
 Seat depth **520**
 Seat height **450-550**
 Back width **485**
 Back height **545**
 Arm height from floor **645-745**



Black air mesh seat with black mesh back



Gas lift adjustment



Weight tension control



Standard tilt lock

Code	Arm type	RRP
HAL300T1-K	Fixed arms	£247





Aurora

The Aurora high back mesh operators chair with black PU headrest is a real statement piece. Designed with durability and comfort in mind with an internal steel frame and deep padded black air mesh seat, Aurora enjoys an ultra contemporary design to style any office.

110 KG



Overall width **600**
 Overall depth **660**
 Overall height **1085-1185**
 Seat width **450**
 Seat depth **480**
 Seat height **460-560**
 Back width **470**
 Back height **700**
 Arm height from floor **650-750**

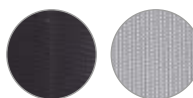

Black air mesh seat with black mesh back

Code **AUR300T1-K** **Arm type** Fixed arms **RRP** **£232**



Gas lift adjustment

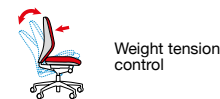

Weight tension control



Standard tilt lock



Jonas Grey

If you're looking for a no frills ergonomic office chair that's built to last and with decent back support, then you simply can't go wrong with the Jonas operators chair. Although this office chair has a minimalist design, it remains a stylish option for your home or workspace.

115 KG



Overall width **580**
 Overall depth **550**
 Overall height **940-1070**
 Seat width **490**
 Seat depth **490**
 Seat height **440-570**
 Back width **450**
 Back height **490**
 Arm height from floor **620-750**



Grey fabric seat with grey mesh back

Code **JNS300T1-G** **Arm type** Fixed arms **RRP** **£225**



Gas lift adjustment

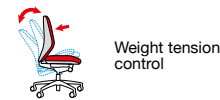

Weight tension control



Standard tilt lock





Jonas Black



If you're looking for a no frills ergonomic office chair that's built to last and with decent back support, then you simply can't go wrong with the Jonas operators chair. Although this office chair has a minimalist design, it remains a stylish option for your home or workspace.



Overall width **580**
 Overall depth **550**
 Overall height **940-1070**
 Seat width **490**
 Seat depth **490**
 Seat height **440-570**
 Back width **450**
 Back height **490**
 Arm height from floor **620-750**



Black fabric seat with black mesh back

Code **JNS300T1-K** **Arm type** Fixed arms **RRP** **£225**



Gas lift adjustment



Weight tension control



Standard tilt lock



Tyler White



Tyler is an infinitely stylish, contemporary mesh back task chair that offers an executive feel in the constraints of a task chair. The chair comes with a modern white frame and integrated fixed arms with a contrasting black fabric seat pad, and the five-star curved base comes as standard in white.



Overall width **560**
 Overall depth **515**
 Overall height **915-980**
 Seat width **480**
 Seat depth **480**
 Seat height **470-545**
 Back width **425**
 Back height **415**
 Arm height from floor **610-690**

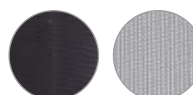

Black air mesh seat with white mesh back

Code **TYL-300T1-WH** **Arm type** Fixed arms **RRP** **£225**



Gas lift adjustment



Weight tension control



Standard tilt lock





115 KG

Tyler Black

Tyler is an infinitely stylish, contemporary mesh back task chair that offers an executive feel in the constraints of a task chair. The chair comes with a modern black frame and integrated fixed arms with a contrasting black fabric seat pad, and the five-star curved base comes as standard in black.



Overall width 560
 Overall depth 515
 Overall height 915-980
 Seat width 480
 Seat depth 480
 Seat height 470-545
 Back width 425
 Back height 415
 Arm height from floor 610-690

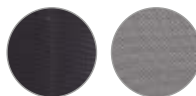

Black air mesh seat with black mesh back

Code TYL-300T1-K **Arm type** Fixed arms **RRP** £225



Gas lift adjustment

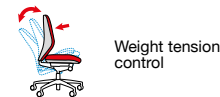

Weight tension control



Standard tilt lock



125 KG

Toto

Not only does this office chair's mesh back keep you cool, it is also designed with contours that cup your spine for optimal lumbar support. The gently curved backrest on the Toto chair follows the shape of your spine, and the mesh material allows ventilation even after prolonged contact.



Overall width 620
 Overall depth 550
 Overall height 920-1010
 Seat width 480
 Seat depth 465
 Seat height 420-510
 Back width 430
 Back height 510
 Arm height from floor 640-730

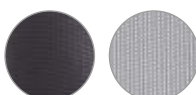

Black fabric seat with black mesh back

Code TOT300T1-K **Arm type** Fixed arms **RRP** £222



Gas lift adjustment

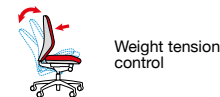

Weight tension control



Standard tilt lock





Nina



Nina provides a sleek, minimalist design that offers effortless comfort. The mesh back allows easy airflow and cooling, while its curved shape follows the spine. The chair's height, tilt adjustability and weight tension is controlled by a minimal butterfly mechanism for ease of use. Complete with fixed supportive armrests.



Overall Width **560**
 Overall Depth **560**
 Overall Height **865-960**
 Seat width **470**
 Seat depth **460**
 Seat height **440-530**
 Back width **450**
 Back height **460**
 Arm height from floor **640-735**

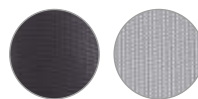

Black fabric seat with black mesh back

Code
NIN300T1-K

Arm type
 Fixed arms

RRP
£180



Gas lift adjustment



Standard tilt lock



Weight tension control



Rhea



For comfort without complexity, Rhea is the ideal solution. Featuring a mesh back with a distinctive design, the curves of the back and seat support the natural shape of the body, providing effortless comfort. Ease of use locking mechanism allows the chair to tilt or lock in place, with seat height adjustment.



Overall Width **580**
 Overall Depth **610**
 Overall Height **895-1015**
 Seat width **435**
 Seat depth **410**
 Seat height **405-525**
 Back width **435**
 Back height **510**
 Arm height from floor **585-705**



Black fabric seat with black mesh back

Code
RHE300T1-K

Arm type
 Fixed arm

RRP
£150



Gas lift adjustment



Tilt rocker



Standard tilt lock





FABRIC TASK CHAIRS

UPHOLSTERED COMFORT TO INDIVIDUAL NEEDS

GRANDEUR



PORTER
308



SENZA ERGO
308



CORNWALL
309



JOTA ERGO
309



SOFIA
310



TUSCAN
310



LUCCA
311



SENZA
311



JOTA
312



CAVALIER
312



BILBAO LUMBAR
313



BILBAO
313



VANTAGE 100
314



VANTAGE 200
315



Porter

Porter is a heavy duty operator chair for usage up to 27 stone that offers extraordinary comfort for less money. The secret to comfort is its high-performance foam formulation and high quality, strong and sturdy materials making it ideal for constant commercial use including shift workers, call centres and security.



- Overall Width 700
- Overall depth 710
- Overall height 1050-1125
- Seat width 545
- Seat depth 505
- Seat height 480-555
- Back width 535
- Back height 620
- Arm height from floor 635-775



Black

Code
POR300T1-K

Arm type
Adjustable arms

RRP
£500



Gas lift adjustment



Standard tilt lock



Senza Ergo

The Senza Ergo seating has been designed to function for heavy duty 24 hour usage in any task or office setting. With its extra high back and adjustable arms, Senza Ergo offers multiple enhanced ergonomic features based on how employees sit and move over the course of a day. BS 5459-2000+A2:2008



- Overall width 670
- Overall depth 650
- Overall height 1050-1180
- Seat width 520
- Seat depth 500
- Seat height 470-600
- Back width 450
- Back height 600
- Arm height from floor 650-850



Black
BLK



Blue
BLU

Code
SXERGOB

Arm type
Adjustable arms

RRP
£470



Back height adjustment



Back rake adjustment



Gas lift adjustment



Weight tension control



Seat depth adjustment



Adjustable lumbar pump





Cornwall



Designed for durability making it perfect for high-intensity environments like call centres, healthcare or public services where chairs need to perform all day, every day. The waterfall seat, soft padded arms and sculptured back delivers ergonomic comfort all day long.

Overall width **660**
 Overall depth **675**
 Overall height **1010-1165**
 Seat width **490**
 Seat depth **500**
 Seat height **470-560**
 Back width **505**
 Back height **600**
 Arm height from floor **670-825**



Code **CWL300K2** **Arm type** Adjustable arms **RRP** **£468**

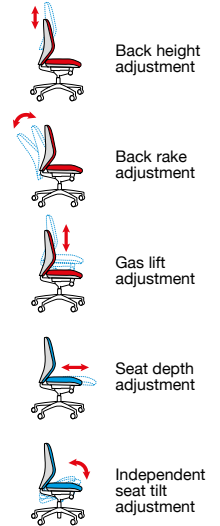

Jota Ergo



The Jota Ergo 24 hour task chair is built for constant use, with a host of ergonomic features that facilitate all-day comfort. Ideal for call centres, hospitals and other institutions that require round-the-clock support, the extra high back & adjustable arms have been designed to increase user comfort & productivity. BS 5459-2000+A2:2008

Overall width **680**
 Overall depth **650**
 Overall height **1050-1180**
 Seat width **520**
 Seat depth **500**
 Seat height **470-600**
 Back width **450**
 Back height **590**
 Arm height from floor **650-850**

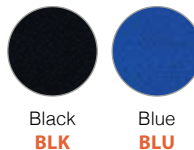

Code **JXERGOB** **Arm type** Adjustable arms **RRP** **£445**

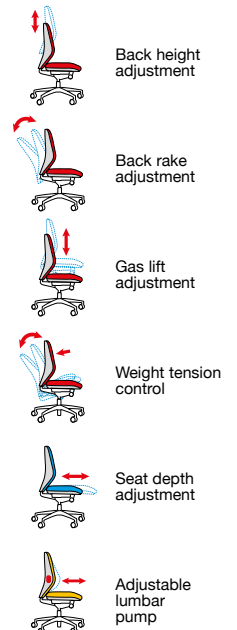



Sofia



Supreme comfort and classic design come together in the Sofia operators chair. With a pneumatic lumbar pad for ultimate comfort and a waterfall seat to reduce stress on the user's knees by having a downward slope at the edge of the seat cushion, Sofia will help you through those long hours at work.

EN 1335-1: 2000

Overall width **645**
 Overall depth **720**
 Overall height **1005-1095**
 Seat width **510**
 Seat depth **485**
 Seat height **440-530**
 Back width **510**
 Back height **560**
 Arm height from floor **640-830**

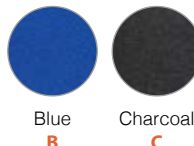

Code
SOF300T1

Arm type
 Adjustable arms

RRP
£400

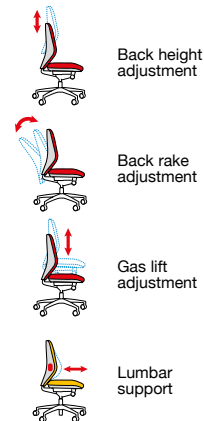

Tuscan



The Tuscan high back operators chair collection has a uniquely shaped back and headrest which ensures the chair adapts to the users back and provides just the right amount of comfort and support. Tuscan has ample cushioning whilst retaining a modern pillow design with sleek contours.

Overall width **690**
 Overall depth **600**
 Overall height **1150-1250**
 Seat width **500**
 Seat depth **530**
 Seat height **470-570**
 Back width **470**
 Back height **730**
 Arm height from floor **470-660**

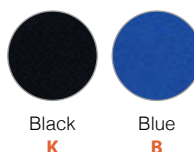

Code
TUS300T1

Arm type
 Pivot arms

RRP
£374

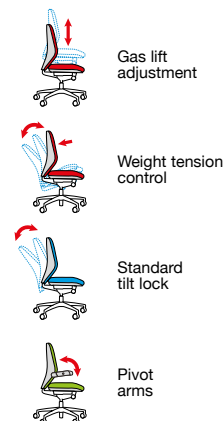



Lucca



Lucca is ideal for manager's offices and front of house areas where style and function are a top priority. The adjustable lumbar, high back, moulded seat and back ensure comfort whilst the gun metal nylon base and arms present a modern design that adds a rich pop of colour to your work space.



Overall width 625
Overall depth 740
Overall height 1095-1185
Seat width 520
Seat depth 490
Seat height 465-565
Back width 520
Back height 700
Arm height from floor 710-800

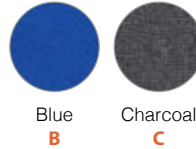

Code
LUC300T1

Arm type
Fixed arms

RRP
£350

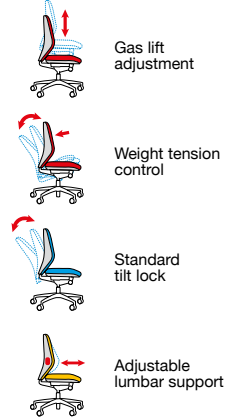

Senza



Comfort, reliability and affordability are the key attributes of the Senza operators chair with its curvaceous profile and vast array of options. Equipped with ergonomic features, a high fabric back and 4 arm options, this operators chair easily provides the comfort needed for a long day at work. BS 5459-2000+A2:2008



Overall width 680
Overall depth 650
Overall height 970-1100
Seat width 520
Seat depth 500
Seat height 470-600
Back width 480
Back height 590
Arm height from floor 620-750 (SH43), 600-800 (SH44), 470-800 (SH46)



Code
SH40-000
SH43-000
SH44-000
SH46-000

Arm type
No arms
Fixed arms
Adjustable arms
Folding arms

RRP
£300
£310
£355
£370

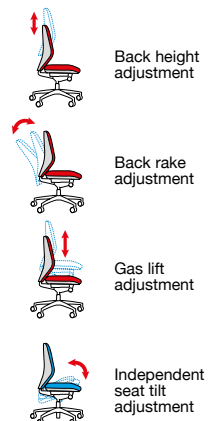



Jota



Jota has a traditional oval shaped back design in a number of arm options, with high density seat and back foam for maximum user comfort. With so many adjustable settings, Jota offers the ideal configuration for any hard-worker, eliminating aches and pains associated with improper support. BS 5459-2000+A2:2008



Overall width **680**
 Overall depth **650**
 Overall height **970-1100**
 Seat width **520**
 Seat depth **500**
 Seat height **470-600**
 Back width **480**
 Back height **510**
 Arm height from floor **620-750 (JH43), 600-800 (JH44), 470-800 (JH46)**

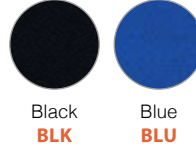

Code	Arm type	RRP
JH40-000	No arms	£270
JH43-000	Fixed arms	£290
JH44-000	Adjustable arms	£325
JH46-000	Folding arms	£345

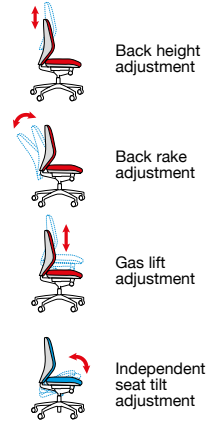

Cavalier



The Cavalier managers chair is a fabric chair in blue or charcoal, both carefully stitched and tufted for plush comfort and a most elegant look. The durable nylon 5 star base and easy glide castors offer maximum comfort and mobility for any office environment.



Overall width **620**
 Overall depth **700**
 Overall height **1010-1100**
 Seat width **505**
 Seat depth **460**
 Seat height **450-540**
 Back width **495**
 Back height **655**
 Arm height from floor **635-725**

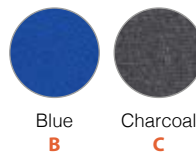

Code	Arm type	RRP
CAV300T1	Fixed arms	£247

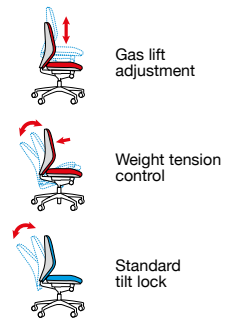



Bilbao Lumbar



The Bilbao operators chair offers more choices than typical operator chairs with a sculptured foam seat, lumbar foam back support and multiple arm options to suit the preferences of office individuals, so you will struggle to find a more comfortable office chair, whilst maintaining a uniform look throughout the office.



Overall width 480
 Overall depth 605
 Overall height 975-1085
 Seat width 480
 Seat depth 445
 Seat height 425-535
 Back width 450
 Back height 480
 Arm height from floor 585-695 (BIL308B1-L), 565-755 (BIL309B1-L)

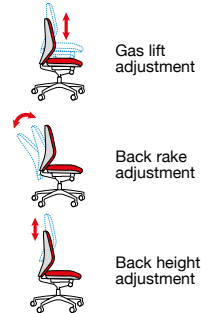
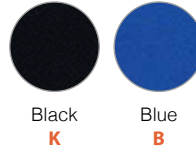

Code	Arm type	RRP
BILB1-L	No arms	£177
BIL308B1-L	Fixed arms	£222
BIL309B1-L	Adjustable arms	£242



Bilbao



Bilbao is an entry level operators chair with a free floating back, designed for a custom supportive fit that will suit any preference or body type. The gas lift, back height and tilt mechanism are all easily adjusted for enhanced comfort to help the user stay relaxed and maximise productivity throughout the working day.



Overall width 480
 Overall depth 605
 Overall height 975-1085
 Seat width 480
 Seat depth 445
 Seat height 425-535
 Back width 450
 Back height 480
 Arm height from floor 585-695 (BIL308B1), 656-755 (BIL309B1)

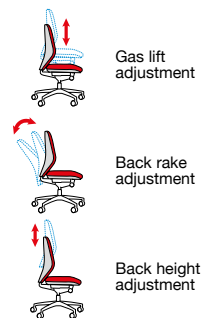
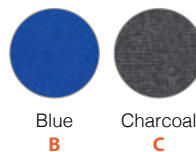

Code	Arm type	RRP
BILB1	No arms	£173
BIL308B1	Fixed arms	£217
BIL309B1	Adjustable arms	£242



STOCKED FABRIC TASK



110
KG

Vantage 100 - 2 Lever

The Vantage 100 fabric chairs are comfortable and affordable, no-nonsense, task chairs which are available from stock in multiple fabric finishes. The contoured seat, back height and back rake adjustment and adjustable seat height increase sitting ease for long periods of time.
EN 1335-1:2000 / EN 1335-2:2009

Overall width 480
Overall depth 605
Overall height 895-1005
Seat width 480
Seat depth 445
Seat height 460-570
Back width 450
Back height 480
Arm height from floor 620-730 (V101), 600-790 (V102)

Code	Arm type	RRP
V100-00	No arms	£185
V101-00	Fixed arms	£227
V102-00	Adjustable arms	£257

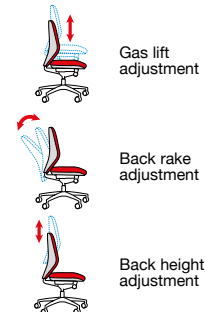

Back rake adjustment



Back height adjustment



Permanent contact back



Contoured seat



110 KG

Vantage 200 - 3 Lever

The Vantage is a highly versatile office chair suitable for a wide array of different tasks and applications. Designed for users who demand comfort and the ability to tailor functions to fit any environment, this chair is the right choice for workstations, collaborative spaces, and everything in between.
EN 1335-1:2000 / EN 1335-2:2009

Overall width 480
Overall depth 605
Overall height 895-1005
Seat width 480
Seat depth 445
Seat height 460-570
Back width 450
Back height 480
Arm height from floor 620-730 (V201), 600-790 (V202)

Code	Arm type	RRP
V200-00	No arms	£220
V201-00	Fixed arms	£260
V202-00	Adjustable arms	£280

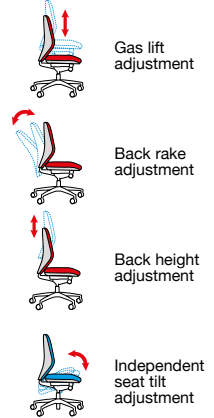
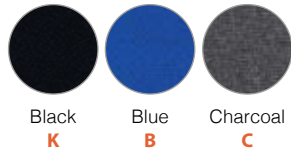

Back rake adjustment



Independent seat tilt adjustment



Back height adjustment



Reclining back with seat tilt option

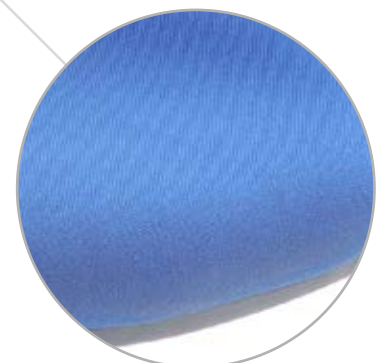

Contoured seat



LEATHER CHAIRS

EXECUTIVE SEATING



FLORENCE
318



FRANKLIN
318



ZEUS HIGH
319



ATLAS
319



ZEUS MEDIUM
320



ODESSA
320



JENSEN
321



PALERMO
321



DERBY
322



CATANIA
322



MARTINEZ
323



TUSCAN
324



NOBLE
324



SOMERSET
325



NANTES
325



BARI HIGH BLACK
323



BARI HIGH
326



BARI MEDIUM
326



HERTFORD
327



CAVALIER
327



ASCONA
327

STOCKED LEATHER



Florence

110 KG

Inspired by Italian design, Florence features black leather on all seating surfaces and a polished chrome base and arms which complement the leather nicely. Besides looking stunning, the Florence chair also has several ergonomic features including lumbar support and a deep padded seat.

Overall width 605
 Overall depth 655
 Overall height 1095-1185
 Seat width 520
 Seat depth 500
 Seat height 485-575
 Back width 525
 Back height 680
 Arm height from floor 670-760



Faux
Leather

Code
FLO300T1

Arm type
 Fixed arms

RRP
£640



Gas lift
adjustment



Weight tension
control



Standard
tilt lock



Franklin

150 KG

Franklin is a deluxe high back executive chair which has a professional, contemporary style. The sculptured seat cushion alleviates the pressure on lower legs and knees while seated and the fully adjustable arms and headrest easily provide the comfort needed for a long day at the office.
 BS 5459-2000+A2:2008

Overall width 665
 Overall depth 645-695
 Overall height 1225-1430
 Seat width 520
 Seat depth 460
 Seat height 480-555
 Back width 510
 Back height 600
 Arm height from floor 700-860



Faux
Leather

Code
FRA400K2

Arm type
 Adjustable arms

RRP
£640



Back height
adjustment



Gas lift
adjustment



Weight tension
control



Back rake
adjustment



Seat depth
adjustment



Synchro
seat & back
tilt lockable options





Zeus High



Named after the god of the sky, the Zeus high back chair boasts refined precision with seductive elegance. Zeus has a triple paddle multi-functional mechanism and represents the executive standard in seating, designed for both style conscious executives and for challenging 24 hour environments. BS 5459-2000+A2:2008



Overall width **670**
 Overall depth **665**
 Overall height **1140-1300**
 Seat width **525**
 Seat depth **460**
 Seat height **480-570**
 Back width **490**
 Back height **685**
 Arm height from floor **680-830**



Faux
Leather

Code	Description	RRP
ZEU300K2	High back	£590

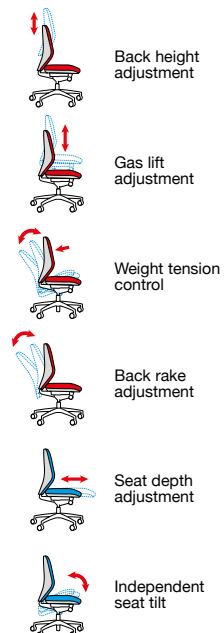

Atlas



Atlas is part of the Grandeur range and is specifically designed with increased proportions in the seat and back. The weight limit of the base and mechanism allow usage for up to 27 stone. Atlas boasts a quality leather faced finish with deep cushion design for extra comfort and support.



Overall width **760**
 Overall depth **800**
 Overall height **1150-1220**
 Seat width **580**
 Seat depth **520**
 Seat height **500-570**
 Back width **580**
 Back height **700**
 Arm height from floor **700-770**



Faux
Leather

Code	Arm type	RRP
ATL300T1	Fixed arms	£580

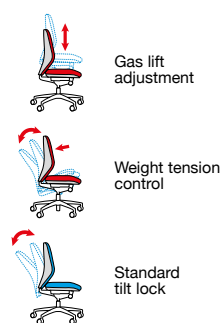



Zeus Medium



Zeus is also available as a medium back chair with a lower back fits like a glove and gives long-lasting comfort. The Zeus chair is crafted according to weight distribution principles and delivers an exciting seating experience, offering an unprecedented elegance that indulges users with maximum comfort. BS 5459-2000+A2:2008



Overall width **670**
 Overall depth **665**
 Overall height **1015-1175**
 Seat width **525**
 Seat depth **460**
 Seat height **480-570**
 Back width **490**
 Back height **560**
 Arm height from floor **680-830**



Faux
Leather

Code	Description	RRP
ZEU200K2	Medium back	£500



Back height adjustment

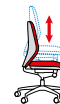

Gas lift adjustment



Weight tension control



Back rake adjustment



Seat depth adjustment



Independent seat tilt



Odessa



With a high back and sleek modern design, the Odessa faux leather managers chair will help executives get the respect they deserve. For some added flair, the chrome base of this managers chair has an attractive contrast to the well-padded black seat and adjustable arms.



Overall width **670**
 Overall depth **670**
 Overall height **1180-1260**
 Seat width **520**
 Seat depth **530**
 Seat height **480-560**
 Back width **510**
 Back height **850**
 Arm height from floor **670-750**



Faux
Leather

Code	Arm type	RRP
ODE300T1	Adjustable arms	£470



Gas lift adjustment



Weight tension control



Locking tilt lock



Jensen

Jensen is a managers chair inspired by racing car seats and specially designed to be used when working at a desk for long periods of time. Supporting the natural S-curve of your back whilst holding the user in the chair for comfort, with the high back for additional head support.

110 KG

Overall width 680
 Overall depth 720
 Overall height 1160-1255
 Seat width 560
 Seat depth 490
 Seat height 470-565
 Back width 510
 Back height 780
 Arm height from floor 715-810



Faux Leather with Red Trim

Code
JEN300T1

Arm type
 Fixed arms

RRP
£425



Gas lift adjustment



Weight tension control



Locking tilt lock



Palermo

Palermo is a luxurious leadership chair that combines comfortable double padding with classic faux leather. With its contemporary design, lumbar support and stylish arms, Palermo is the seat of comfort for the head of a boardroom conference table or the corner office.

110 KG

Overall width 645
 Overall depth 720
 Overall height 1105-1180
 Seat width 530
 Seat depth 520
 Seat height 505-575
 Back width 530
 Back height 705
 Arm height from floor 670-745



Faux Leather

Code
PAL300K2

Arm type
 Fixed arms

RRP
£420



Gas lift adjustment



Weight tension control



Knee tilt adjustment





Derby

110 KG



Overall width 675
 Overall depth 785
 Overall height 1160-1230
 Seat width 545
 Seat depth 545
 Seat height 490-550
 Back width 530
 Back height 755
 Arm height from floor 665-735



Faux Leather

Code
DER300T1-BLK **Arm type**
 Fixed arms **RRP**
 £417



Gas lift adjustment



Weight tension control



Standard tilt lock



Catania

110 KG



Overall width 645
 Overall depth 760
 Overall height 1095-1185
 Seat width 520
 Seat depth 520
 Seat height 510-600
 Back width 520
 Back height 700
 Arm height from floor 710-800



Brown Leather Faced

Code
CAT300T1 **Arm type**
 Fixed arms **RRP**
 £394



Gas lift adjustment



Weight tension control



Standard tilt lock





Bari High Black



The Bari executive chair is perfect for adding a touch of style to your office. The contemporary black ribbed faux leather faced design has a high back that will add some much needed comfort to employees and visitors, with black arms and a black base that will always look sleek and stylish.



Overall width **540**
 Overall depth **770**
 Overall height **1020-1120**
 Seat width **495**
 Seat depth **500**
 Seat height **430-530**
 Back width **470**
 Back height **660**
 Arm height from floor **690-770**



Faux Leather

Code	Description	RRP
BARI300T1-K	High back	£311

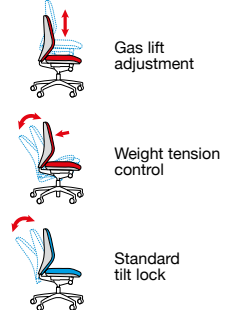

Martinez



Martinez provides beautiful contemporary styling making it a trendy option for managers. Features include a diagonally patterned, curved back available in a black leather and panel stitching which highlights the design, finished with chrome padded arms for a stunning looking executive chair.



Overall width **550**
 Overall depth **700**
 Overall height **970-1060**
 Seat width **480**
 Seat depth **460**
 Seat height **495-585**
 Back width **470**
 Back height **585**
 Arm height from floor **680-770**



Faux Leather

Code	Arm type	RRP
MAR50004	Fixed arms	£384

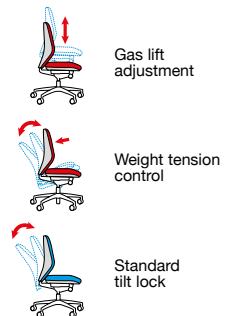

• Shown with optional glides (also supplied)



Tuscan



The Tuscan high back managers chair has a uniquely shaped back and headrest which ensures the chair adapts to the users back and provides just the right amount of comfort and support. Available in black leather, Tuscan has ample cushioning whilst retaining a modern pillow design.



Overall width 690
 Overall depth 600
 Overall height 1150-1250
 Seat width 500
 Seat depth 530
 Seat height 470-570
 Back width 470
 Back height 730
 Arm height from floor 470-660



Faux
Leather

Code **Arm type** **RRP**
TUS300T1-BLK Pivot arms **£374**

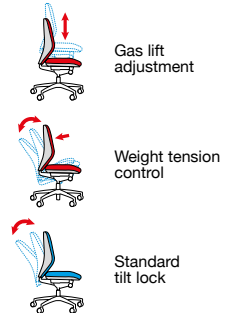

Noble



Noble is a black faux leather, high back managers chair that is designed for comfort with a look that would fit any workplace. The swivel base and high back on this executive office chair offer maximum comfort and mobility and the adjustable seat features thick padding covered in soft and supple bonded leather.



Overall width 690
 Overall depth 690
 Overall height 1245-1345
 Seat width 540
 Seat depth 530
 Seat height 490-590
 Back width 540
 Back height 860
 Arm height from floor 690-770



Faux
Leather

Code **Arm type** **RRP**
NBO300T1 Fixed arms **£360**

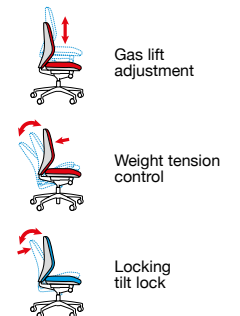



Somerset

110 KG

The Somerset executive chair features a high back with headrest and a stylish black leather faced finish for a bold appearance. Somerset is designed for long work sessions with supreme padding, a pronounced lumbar and waterfall seat design that lets you take care of business.



Overall width 630
Overall depth 720
Overall height 1100-1190
Seat width 490
Seat depth 485
Seat height 500-590
Back width 490
Back height 710
Arm height from floor 670-760



Leather Faced

Code
SOM300T1

Arm type
Fixed arms

RRP
£328



Gas lift adjustment



Weight tension control



Standard tilt lock



Nantes

110 KG

The Nantes chair is the ideal accompaniment to the workplace or managers office with its black faux leather stylish profile. Featuring a breathable mesh and back side panel, Nantes also has a deep seat, a padded back and upholstered arms that will ensure the user is supremely comfortable.



Overall width 645
Overall depth 720
Overall height 1080-1180
Seat width 515
Seat depth 500
Seat height 510-600
Back width 515
Back height 725
Arm height from floor 685-775



Faux Leather

Code
NAN300T1

Arm type
Fixed arms

RRP
£325



Gas lift adjustment



Weight tension control



Standard tilt lock





Bari High

The Bari executive chair is perfect for adding a touch of style to your office. The contemporary black ribbed faux leather faced design has a high back that will add some much needed comfort to employees and visitors, with chrome arms and a chrome base that will always look sleek and stylish.

110 KG

Overall width 540
 Overall depth 770
 Overall height 1020-1120
 Seat width 495
 Seat depth 500
 Seat height 430-530
 Back width 470
 Back height 660
 Arm height from floor 690-770



Faux Leather

Code	Description	RRP
BARI300T1	High back	£311



Gas lift adjustment



Weight tension control



Standard tilt lock



Bari Medium

Bari is also available as a medium back leather executive chair featuring all-around comfort to your body. It is scientifically and efficiently designed to ensure soft support and spinal alignment with the ribbed design, with lumbar support and a tilting mechanism that brings an unparalleled sitting experience.

110 KG

Overall width 540
 Overall depth 770
 Overall height 820-920
 Seat width 495
 Seat depth 500
 Seat height 430-530
 Back width 470
 Back height 460
 Arm height from floor 690-770

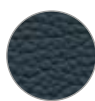

Faux Leather

Code	Description	RRP
BARI200T1	Medium back	£301



Gas lift adjustment



Weight tension control



Standard tilt lock





Hertford

The ruched upholstery details and plush comfort make Hertford a prestigious choice for executives. Finished in black leather with fixed black arms, the Hertford managers chair has a chrome base with easy glide castors which are perfect for hard surfaces.

Overall width **620**
 Overall depth **735**
 Overall height **1090-1180**
 Seat width **490**
 Seat depth **490**
 Seat height **495-585**
 Back width **485**
 Back height **665**
 Arm height from floor **675-765**



Leather Faced

Code **HER300T1** **Arm type** Fixed arms **RRP** **£281**

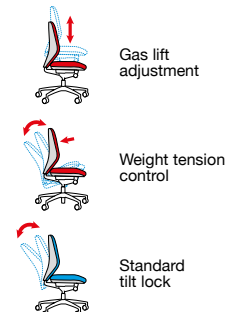

Cavalier

The Cavalier managers chair is a soft, supple leather faced chair carefully stitched and tufted for plush comfort for a most elegant look. The durable nylon 5 star base and easy glide castors offer maximum comfort and mobility for any office environment. BS1335-1:2000

Overall width **620**
 Overall depth **690**
 Overall height **1010-1100**
 Seat width **510**
 Seat depth **470**
 Seat height **450-540**
 Back width **510**
 Back height **650**
 Arm height from floor **635-725**

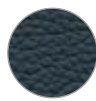

Leather Faced

Code **CAV300T1** **Arm type** Fixed arms **RRP** **£232**

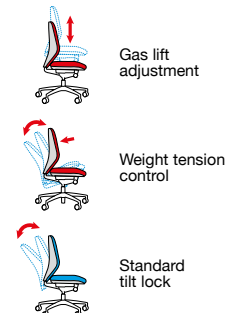

Ascona

With a focus on comfort and support, the Ascona high back managers chair will not look out of place in any office setting. Upholstered with high quality synthetic leather and extra plush padding, this sturdy black chair is supported by a black base making it easy to move around.

Overall width **620**
 Overall depth **630**
 Overall height **1040-1140**
 Seat width **500**
 Seat depth **500**
 Seat height **430-530**
 Back width **490**
 Back height **680**
 Arm height from floor **650-750**



Faux Leather

Code **ASC300T1** **Arm type** Fixed arms **RRP** **£222**

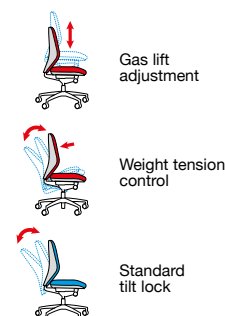

STOCKED LEATHER



MEETING CHAIRS

SLEEK, COMFORTABLE, AND CONVENIENT



BRUGES
330



DERBY
331



NOBLE
331



BARI BLACK
332



BARI
332



ESSEN GREY
333



ESSEN BLACK
333



CAVALIER
334



SOLARIS
334



JONAS
335



TOTO
335



Bruges

The cool, contemporary Bruges meeting chair is durably constructed for long-term enjoyment and comfort. They have plush faux leather faced half backs and seats which are held firmly in place by a chrome cantilever support system and upholstered armrests for added comfort.

Overall width 570
 Overall depth 580
 Overall height 780
 Seat width 485
 Seat depth 345
 Seat height 445
 Back width 480
 Back height 295



Faux
Leather



Sold in pack of 2



Code	Description	RRP
BRU100C1	Fixed arms	£561





Derby

The Derby visitors chair is an ideal solution for any professional environment, in a black faux leather finish with mesh side panels to aid ventilation throughout the working day. The waterfall seat and contoured back provide top ergonomic support, easing stress at crucial points.

110
KG

Overall width 655
Overall depth 710
Overall height 950
Seat width 540
Seat depth 500
Seat height 500
Back width 510
Back height 670



Faux
Leather

Code	Arm type	RRP
DER100C1-BLK	Fixed arms	£394



Noble

The Noble visitors chair is designed for comfort with a look that would fit any office or conference room. The high back and thick padding covered in soft and supple faux leather and white stitching detail looks great with the padded fixed arms featuring black trim to match the black cantilever base.

115
KG

Overall width 640
Overall depth 710
Overall height 1200
Seat width 500
Seat depth 520
Seat height 510
Back width 500
Back height 740



Faux
Leather

Code	Arm type	RRP
NBO100C1	Fixed arms	£325





Bari Black



The Bari executive visitors chair is perfect for adding a touch of style to your office or conference room. The classic black ribbed faux leather design will add some much-needed comfort to employees and visitors, with black arms and a black base that will always look sleek and stylish.

Overall width **560**
 Overall depth **575**
 Overall height **870**
 Seat width **490**
 Seat depth **445**
 Seat height **450**
 Back width **470**
 Back height **450**



Faux
Leather

Code	Description	RRP
BARI100C1-K	Fixed arms	£259



Bari



The Bari executive visitors chair is perfect for adding a touch of style to your office or conference room. The classic black ribbed faux leather design will add some much-needed comfort to employees and visitors, with chrome arms and a chrome base that will always look sleek and stylish.

Overall width **560**
 Overall depth **575**
 Overall height **870**
 Seat width **490**
 Seat depth **445**
 Seat height **450**
 Back width **470**
 Back height **450**



Faux
Leather

Code	Arm type	RRP
BARI100C1	Fixed arms	£259





Essen Grey



Essen's chrome cantilever frame and leather faced seat and back offers a sophisticated style with a hint of retro. Available in black or grey with matching padded arms, the smoothly shaped seat and back gently cradle and support the body, providing lateral and lumbar support when in use. BS EN 16139:2013 level 1



Overall width **555**
 Overall depth **605**
 Overall height **885**
 Seat width **480**
 Seat depth **430**
 Seat height **460**
 Back width **480**
 Back height **470**



Grey faux
 Leather



Stackable
 up to 6 high

Code	Description	RRP
ESS100S2-G	Fixed arms	£256



Essen Black



Essen's chrome cantilever frame and leather faced seat and back offers a sophisticated style with a hint of retro. Available in black or grey with matching padded arms, the smoothly shaped seat and back gently cradle and support the body, providing lateral and lumbar support when in use. BS EN 16139:2013 level 1



Overall width **555**
 Overall depth **605**
 Overall height **885**
 Seat width **480**
 Seat depth **430**
 Seat height **460**
 Back width **480**
 Back height **470**



Black faux
 Leather



Stackable
 up to 6 high

Code	Description	RRP
ESS100S2-K	Fixed arms	£256





Cavalier



The Cavalier visitors chair will make a stunning addition to any conference room or waiting area. The soft, supple leather faced chair is carefully stitched and tufted for plush comfort, which is enhanced by the black cantilever frame and matching fixed arms for a classic feel.



Overall width 630
Overall depth 610
Overall height 1010
Seat width 520
Seat depth 460
Seat height 470
Back width 495
Back height 605



Leather Faced

Code
CAV100C1

Arm type
Fixed arms

RRP
£232



Solaris



The Solaris mesh back visitors chair has a stylish injection moulded back with breathable mesh and a sculptured lumbar adjustment, which allows the user to sit with optimal comfort and personalised support. Its ergonomic design can increase energy and improve productivity.



Overall width 650
Overall depth 600
Overall height 940
Seat width 490
Seat depth 500
Seat height 470
Back width 480
Back height 520

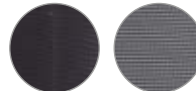

Black fabric seat with black mesh back

Code
SOL100C1-K

Arm type
Fixed arms

RRP
£222





Jonas



Create a comfortable, yet functional visitor area without breaking the bank with the Jonas visitors chair. Jonas offers a stylish back design and comes with fixed arms and a chrome base as standard. The mesh back allows air flow to the users back throughout long meetings.

Overall width 570
Overall depth 550
Overall height 930
Seat width 490
Seat depth 490
Seat height 420
Back width 440
Back height 490



Black fabric seat with black mesh back

Code
JNS100C1-K

Arm type
Fixed arms

RRP
£222



Toto



The Toto visitors chair provides the perfect seating for visitors to the office with its gently curved backrest and comfortable soft moulded foam. Ideal for use in meeting spaces and training rooms, it features a chrome cantilever frame and the mesh back is designed to keep the user cool and relaxed.

Overall width 610
Overall depth 550
Overall height 950
Seat width 475
Seat depth 460
Seat height 420
Back width 440
Back height 510

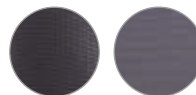

Black fabric seat with black mesh back

Code
TOT100C1-K

Arm type
Fixed arms

RRP
£222





MULTI-PURPOSE CHAIRS & STOOLS

VERSATILE AND ADAPTABLE
TO SUPPORT DYNAMIC SPACES



AVA
338



PREMA
338



CODA
339



PRAGUE
339



TAURUS FABRIC
340



TAURUS CHROME
340



TAURUS MESH
341



TAURUS PLASTIC
341



TAURUS WOOD
342



JIVE BLACK
342



JIVE CHROME
343



QUAVO
343



GECKO
344



GECKO
344



SIENNA
345



SIENNA
345

STOCKED MULTI-PURPOSE



Ava

The Ava provides an innovative perch stool solution for an agile office environment. With its swivelling seat and height-adjustment capabilities, this active stool matches its refined look with easy to use functionality, while promoting good posture. Ava's black nylon frame is coordinated with a black fabric.

Overall width **425**
 Overall depth **360**
 Overall height **565-715**
 Seat width **380**
 Seat depth **330**
 Seat height **465-715**
 Back width **na**
 Back height **na**



Black
Fabric



Code
AVA01-K

Arm type
No arms

RRP
£190



Prema

The Prema industrial operator chair is an entry level laboratory and workplace chair featuring a fully adjustable, strong polyurethane back and seat that can be wiped clean. Prema is ideal for research industries including laboratories, universities and school science rooms or for use with a tall bench. BS EN 16139:2013 level 1

Overall width **455**
 Overall depth **635**
 Overall height **950-1080**
 Seat width **455**
 Seat depth **430**
 Seat height **605-735**
 Back width **410**
 Back height **305**

Code
PRM300G1

Description
No arms

RRP
£323





Coda

Coda is a general use conference room or meeting chair with a chrome frame and padded seat cushions that combine comfort with long lasting durability. With its classic and simple yet stylish, practical design, Coda is suitable for all high traffic areas. EN 12520

Overall width **580** (No arms **490**)
 Overall depth **570**
 Overall height **930**
 Seat width **440**
 Seat depth **470**
 Seat height **480**
 Back width **450**
 Back height **380**

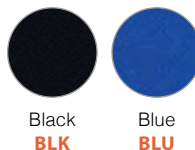

Stackable up to 4 high

Code	Arm type	RRP
COD100H	No arms	£180
COD101H	Fixed arms	£225



Prague

The Prague chair's sleek curves, combined with a modern aesthetic, make it the perfect addition to any office space. Due to the laminated bent wood frame and clear hard wearing lacquer, you can rest assured that these meeting chairs are built to handle constant, everyday use.

Overall width **530**
 Overall depth **560**
 Overall height **820**
 Seat width **460**
 Seat depth **470**
 Seat height **450**
 Back width **465**
 Back height **230**

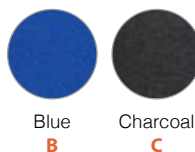

Stackable up to 4 high

Code	Arm type	RRP
PRA50001	Fixed arms	£210
PRA50002	No arms	£192





Taurus Black

Taurus stacking chairs offer an attractively sleek and comfortable seating solution for any office meeting room or educational establishment. With a black frame, Taurus has contoured cushions which provide excellent support, with an easy to fit chair link available to connect chair frames.

Overall width 530 (With arms 640, Tablet 590)
 Overall depth 540
 Overall height 810
 Seat width 470
 Seat depth 440
 Seat height 460
 Back width 470
 Back height 340

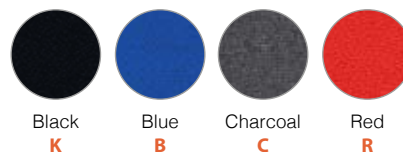

Code	Description	RRP
Black frame		
TAU40002	No arms	£92
TAU40003	Fixed arms	£153
TAU40004	Writing tablet	£188



Stackable up to 6 high (not writing tablet)



TAULINK
Linking bracket £31



Taurus Chrome

Taurus stacking chairs offer an attractively sleek and comfortable seating solution for any office meeting room or educational establishment. With a chrome frame, Taurus has contoured cushions which provide excellent support, with an easy to fit chair link available to connect chair frames.

Overall width 530 (With arms 640, Tablet 590)
 Overall depth 540
 Overall height 810
 Seat width 470
 Seat depth 440
 Seat height 460
 Back width 470
 Back height 340

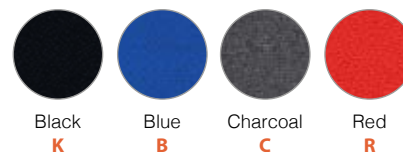

Code	Description	RRP
Chrome frame		
TAU40005	No arms	£94
TAU40006	Fixed arms	£155
TAU40007	Writing tablet	£191



Stackable up to 6 high (not writing tablet)



TAULINK
Linking bracket £31



Taurus Plastic

With its slim and stylish profile, Taurus plastic back chairs in blue and black are perfect for today's lighter, more flexible office aesthetic. The polyurathene moulded seat and back and wooden versions of this best-selling chair offer versatility and poise, with an easy to fit chair link available.



Overall width 530 (With arms 640, Tablet 590)
 Overall depth 540
 Overall height 810
 Seat width 470
 Seat depth 440
 Seat height 450
 Back width 470
 Back height 340

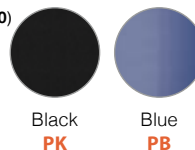

Code	Arm type	RRP
TAU40002	No arms	£92
TAU40003	Fixed arms	£153
TAU40004	Writing tablet	£188



Stackable up to 8 high (not writing tablet)



TAULINK
 Linking bracket £31



Taurus Mesh

The Taurus mesh back variant is a versatile multi-purpose chair that adds refined, contemporary appeal just about anywhere its put to work. The black frame, black fabric seat, and black mesh back provides a simple, classic look that allows you to lock in the style that suits your décor.



Overall width 530 (With arms 640, Tablet 590)
 Overall depth 540
 Overall height 810
 Seat width 470
 Seat depth 440
 Seat height 460
 Back width 470
 Back height 340

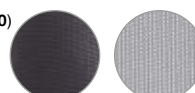

Code	Arm type	RRP
TAUMK	No arms	£104
TAUMA	Fixed arms	£202
TAUMKW	Writing tablet	£219



Stackable up to 6 high (not writing tablet)



TAULINK
 Linking bracket £31





Taurus Wood

From the training room to the office canteen and waiting spaces, the Taurus wooden chair is ideal as a multi-functional work chair. A sturdy frame in chrome and elegant beech seat and back combine with an essential design, and it will even stack up to save space when not in use.



Overall width **530** (With arms **640**, Tablet **590**)
 Overall depth **540**
 Overall height **810**
 Seat width **470**
 Seat depth **440**
 Seat height **460**
 Back width **470**
 Back height **340**



Beech



Stackable up to 8 high (not writing tablet)



TAULINK
 Linking bracket **£31**

Code	Arm type	RRP
TAU40005-W	No arms	£121
TAU40006-W	Fixed arms	£183
TAU40007-W	Writing tablet	£220



Jive Black

A stylish meeting chair, with a distinctive shape set on a skid frame. Ideal for large conference spaces, meeting, training and dining areas. Available with or without arms, in black frames & upholstered seat & back in blue or black fabric. Jive's crossbar designed frame provides additional durability & stability.



Overall width **515**
 Overall depth **550**
 Overall height **845**
 Seat width **406**
 Seat depth **430**
 Seat height **455**
 Back width **460**
 Back height **390**



Black
K



Blue
B



Stackable up to 10 high

Code	Arm type	RRP
JIV300K	No arms	£120
JIV301K	Fixed arms	£180





Jive Chrome

A stylish meeting chair, with a distinctive shape set on a skid frame. Ideal for large conference spaces, meeting, training and dining areas. Available with or without arms, in chrome frames & upholstered seat & back in blue or black fabric. Jive's crossbar designed frame provides additional durability & stability.

Overall width 515
 Overall depth 550
 Overall height 845
 Seat width 406
 Seat depth 430
 Seat height 455
 Back width 460
 Back height 390



Black **K** Blue **B**



Stackable up to 10 high

Code	Arm type	RRP
JIV300C	No arms	£130
JIV301C	Fixed arms	£190



Quavo

In collaborative spaces, chairs are always being moved. That's why the lightweight and portable Quavo chair is such a fitting addition to the places people gather. Quavo is a multi-purpose chair that is made for any office environment, with a mesh back, fabric seat and a sled frame.

Overall width 420
 Overall depth 550
 Overall height 855
 Seat width 415
 Seat depth 465
 Seat height 450
 Back width 445
 Back height 390

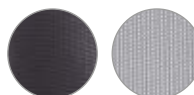

Black fabric seat with black mesh back



Stackable up to 20 high

Code	Description	RRP
QVO40005-K	Sled frame	£640



Sold in pack of 4



Gecko

The stylish Gecko dining chairs have a turtle shell design which is designed for maximum comfort and durability due to the easy clean curvaceous shape. Gecko seating is available in a multitude of colour options to complement the white seat, for a fun and easy match with any decorating style.



Overall width 550
Overall depth 520
Overall height 830
Seat width 550
Seat depth 520
Seat height 480
Back width 410
Back height 400



Stackable up to 10 high

Code	Description	RRP
CH8301	Chrome 4 leg	£286



Gecko

The stylish Gecko dining chairs and stools have a turtle shell design which is designed for maximum comfort and durability due to the easy clean curvaceous shape. Gecko seating is available in a multitude of colour options to complement the white seat, for a fun and easy match with any decorating style.



Overall width 510
Overall depth 510
Overall height 1120
Seat width 510
Seat depth 510
Seat height 800
Back width 410
Back height 400

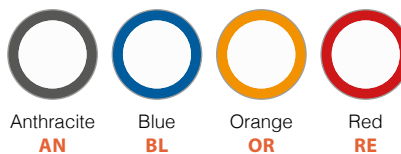

Stackable up to 4 high

Code	Description	RRP
HS8301	No arms	£404





Sienna

Sienna is a moulded plastic dining chair and stool collection which is a fantastic contemporary choice and would make a stylish addition to any dining facility or café. The curved retro design is available with a chrome frame and is a practical and durable choice due to the easy clean curvaceous surface.



Overall width 455
Overall depth 500
Overall height 830
Seat width 455
Seat depth 500
Seat height 475
Back width 460
Back height 420



Black
K



Blue
BL



Grey
G



Orange
OR

Code
SIE50001

Description
Chrome 4 leg

RRP
£500



Stackable
up to 10 high



Sold in
pack of 4



Sienna

Sienna is a moulded plastic dining chair and stool collection which is a fantastic contemporary choice and would make a stylish addition to any dining facility or café. The curved retro design is available with a chrome frame and is a practical and durable choice due to the easy clean curvaceous surface.



Overall width 455
Overall depth 500
Overall height 1140
Seat width 455
Seat depth 500
Seat height 785
Back width 460
Back height 420



Black
K



Blue
BL



Grey
G



Orange
OR

Code
SIE50009

Description
No arms

RRP
£460



Sold in
pack of 2





SOFT SEATING
CREATE WELCOMING ENVIRONMENTS



ALPHA
348



HANNA
349



CORBY
352



LIANA
351



DECCO
352



LONDON
353



LUXE
354



UNA
355



MELODY
356



BENOTTO
357



HELSINKI
358



MUSE
359



Alpha lounge chairs blend simplicity and comfort, with an elegant design featuring arms and a headrest. Ideal for various spaces, Alpha radiates modern style and grace while providing a cosy and flexible seating solution. Lounge chair distinctive features include black cross frame base and piped stitch detailing.

Eye-catching, timeless high back design in a velvet fabric. Available in two finishes

Head rest, neck support and integral lumbar add to its functionality

Modern office or lounge seat with broad appeal and strong character

Ideal around a coffee table in a reception or waiting area for visitors



CODE	Description	RRP
ALP01	Armchair	£640

	Overall width	Overall depth	Overall height	Seat width	Seat depth	Seat height	Back width	Back height
ALP01	750	780	930	530	510	420	550	590

FABRIC OPTIONS



Dark Blue (DB)



Mustard (MU)



STOCKED SOFT SEATING



CODE	Description	RRP
HAN02-G	2 Seater Sofa	£787



CODE	Description	RRP
HAN01-G	Single Seater	£525

Our Hanna compact 1 & 2 seater sofas work in just about every environment.

Featuring natural ash wooden construction for a sturdy structure. Paired wonderfully with thick padded upholstered seat and back cushion for extra comfort.

Elegant natural design combining oak stained ash & upholstered back and base

Available in 1 & 2 seater combinations and complimentary coffee table

Designed for breakout, waiting or reception environments

Easy to assemble seating units finished with non slip feet for extra floor protection



CODE	Description	RRP
HAN03-G	Oval Coffee Table	£311

	Overall width	Overall depth	Overall height	Seat width	Seat depth	Seat height	Back width	Back height
HAN01-G	680	750	810	620	500	430	620	460
HAN02-G	1300	750	810	1240	500	430	1240	460
HAN-CT	1100	650	350					



FINISH OPTIONS



Grey



Oak stained



Corby soft seating, available in blue and grey, offers a comfortable and lightweight design. Corby is a distinctive lounge chair, versatile and relaxed elements easily adapt to lounge spaces or open offices, making it a practical and competitively priced choice for collaborative areas.



Lounge chair clean lines and minimalist design suit any setting

Sturdy black metal frame but lightweight for easy rearranging

Ideal placement around a coffee table in a reception or waiting area

Velvet-style fabric finish for style and elegance. Available in two finishes

CODE	Description	RRP
COR01	Armchair	£450

	Overall width	Overall depth	Overall height	Seat width	Seat depth	Seat height	Back width	Back height
COR01	670	700	710	520	520	410	490	400



FABRIC OPTIONS



Light Blue (LB)



Dark Grey (DG)



STOCKED SOFT SEATING

The Liana lounge seating inspires people to come together with new ideas, new priorities and new ways of thinking. Liana is ideal for soft workplace settings the likes of meeting areas, breakout spaces, presentation facilities, waiting applications, lounge and reception areas.

Comfortable and supportive with a sturdy black metal frame for easy rearranging.

Cushions with arm rests designed to fit the curve of the body

Placement ideal around a coffee table in a reception or waiting area

A choice of 2 fabric colours, Mid Blue & Light Grey



CODE	Description	RRP
LIA01	Armchair	£443

CODE	Description	RRP
LIA02	2 seater sofa	£725

	Overall width	Overall depth	Overall height	Seat width	Seat depth	Seat height	Back width	Back height
LIA01	780	670	750	510	500	430	470	420
LIA02	1490	670	750	510	500	430	470	420



FABRIC OPTIONS



Mid-blue (MB)



Light Grey (LG)



Decco reception chairs feature ergonomic ribbed back support and finished in quality faux leather in brown. Decco minimalistic compact design offers fresh, luxurious seating for visitors, ideal for any office lounge space or reception areas where style and comfort are key.

Multi-use compact design with black feature skid frame and feet protectors

Distinctive, fluted design for increased seating comfort

Understated compact aesthetic suitable for a wide range of interiors

Lounge chair Ideally placed around a coffee table in a reception or waiting area

CODE	DESCRIPTION	RRP
DEC01-BR	Single chair	£335

	Overall width	Overall depth	Overall height	Seat width	Seat depth	Seat height	Back width	Back height
DEC01-BR	640	710	810	600	490	470	610	400



FABRIC OPTIONS



Brown
Faux Leather



London tub chairs, upholstered in faux leather, combine comfort with sturdy construction. Their compact size offers flexibility in placement, making them a durable and stylish choice for numerous settings the likes of informal meeting, breakout, waiting and reception areas.



Comfortable single seater tub chair, perfect for receptions or waiting rooms

Outstanding example of good taste and a classic, timeless design

Durable black faux leather with generous deep cushioned seat and open base

Stylish high back tub style chair provided with glides for easy movement

CODE	DESCRIPTION	RRP
LON50001	Single chair	£542

	Overall width	Overall depth	Overall height	Seat width	Seat depth	Seat height	Back width	Back height
LON50001	670	670	770	430	490	430	460	340



FABRIC OPTIONS



Black Faux Leather



Stylish yet conveniently sized, the Luxe seating range is ideal for any reception or waiting area, or any confined space. The tub chair provides a comfortable position, supporting a healthy posture. Luxe's floating seat aesthetic provides both comfort and improved ergonomics.



Single seat armchair provides spacious comfort with a strong and sturdy on nylon glides

The Luxe double seater is generously proportioned to accommodate two people comfortably.

The fluid curves of the tub design generate a soft impression, providing comfort with the curved back.

Available in cobalt blue or smoke grey, ideal for any high-traffic environment or breakout space.

CODE	DESCRIPTION	RRP	CODE	DESCRIPTION	RRP			
LUX50001	Single Seater	£375	LUX50002	Double Seater	£550			
	Overall width	Overall depth	Overall height	Seat width	Seat depth	Seat height	Back width	Back height
LUX50001	700	650	850	470	500	470	450	410
LUX50002	1300	650	850	970	500	470	950	410



FABRIC OPTIONS



Cobalt Blue
CB



Smoke Grey
SG



STOCKED SOFT SEATING

A modular twist on the classic reception seat, Una can be utilised alone or with multiple units pushed together to create seating of any required proportion or configuration. The waterfall design of the seat ensures ergonomic comfort, allowing the user to sit back in the seat and have their legs fully supported.



The simplicity and angular nature of Una's design contributes to its adaptability, ensuring comfort for its occupants.

Single seat chair provides spacious comfort with a strong, robust construction and stability on nylon glides.

The modular singular design provides familiar placement whilst allowing for easy reconfiguration

Available in cobalt blue or smoke grey, ideal for any high-traffic environment or breakout space.

CODE	DESCRIPTION	RRP
UNA50001	Single Seater	£225

	Overall width	Overall depth	Overall height	Seat width	Seat depth	Seat height	Back width	Back height
UNA50001	580	640	770	580	490	420	580	360



FABRIC OPTIONS



Cobalt Blue
CB



Smoke Grey
SG



Melody seating range would not look amiss in any contemporary office. Its strong, squared elements provide a strong aesthetic while the subtly sloped back and padded seat ensure comfort. Melody enhances any breakout or reception space with its contemporary aesthetic.

Melody's seating range consists of well-proportioned single seat armchair and two seater sofa

The design provides wide armrest, and combines a comfortable sit with a strong, robust construction

The simplicity and angular nature of Melody's design contributes to its adaptability, ensuring comfort

Available in cobalt blue or smoke grey to compliment any corporate interior

CODE	DESCRIPTION	RRP
MEL50001	Single Seater	£400

CODE	DESCRIPTION	RRP
MEL50002	Double Seater	£650

	Overall width	Overall depth	Overall height	Seat width	Seat depth	Seat height	Back width	Back height
MEL50001	830	710	850	555	525	455	555	395
MEL50002	1340	710	850	1105	525	455	1105	395



FABRIC OPTIONS



Blue
CB



Grey
SG



STOCKED SOFT SEATING

Benotto chairs feature a wrap-around design and faux leather upholstery, providing comfort and durability. The square stainless steel frame and cylindrical legs add a contemporary touch, making them a stylish statement piece for receptions, waiting and lobby areas.



Available in single seat, two and three seater sofa combinations

With feature curved, padded wrap around sides and back rest

Square polished underframe with cylindrical leg design

Durable faux leather black upholstery with deep cushioned seats

CODE	DESCRIPTION	RRP
BEN50001	Single chair	£738
BEN50002	Two seater	£984
BEN50003	Three seater	£1475

	Overall width	Overall depth	Overall height	Seat width	Seat depth	Seat height	Back width	Back height
BEN50001	770	680	740	520	545	450	520	330
BEN50002	1150	680	740	890	545	450	890	330
BEN50003	1650	680	740	1400	545	450	1400	330



FABRIC OPTIONS



Black Faux Leather



Helsinki reception chairs, with deep padded seats and backs, offer luxurious comfort and modern sophistication. Available in black leather with complementary silver base, these chairs are perfect for reception areas or workspaces where users may sit for extended periods.



Black leather faced reception seating ideal for any modern interior

Square reception sofas available in 1, 2 and 3 seater combinations

Tubular square silver steel base and legs for strength and stability

Features deep cushioned seats and backs with a square block design, creating a stylish effect

CODE	DESCRIPTION	RRP
HEL50001	Single chair	£787
HEL50002	Two seater	£1279
HEL50004	Three seater	£1672

	Overall width	Overall depth	Overall height	Seat width	Seat depth	Seat height	Back width	Back height
HEL50001	770	710	850	555	525	455	555	395
HEL50002	1340	710	850	1105	525	455	1105	395
HEL50004	1880	710	850	1640	525	455	1640	395



FINISH



Black Leather Faced



STOCKED SOFT SEATING



Muse is a four-seater meeting booth with stylish integrated table. The distinctive shape of the side panels follows the natural curve of the spine, ensuring ergonomic comfort for any meeting situations. Available in two seat, back and infill panels, fabric colour combinations.

High back design provides privacy for its occupants, whilst the open ended creates easy accessibility.

Complete with central white work area table top, supported on central column tubular leg

Two generously proportioned seating units designed to comfortably fit two people

Strong ergonomic comfort, is matched by a robust construction and stability on black tubular legs

CODE	DESCRIPTION	RRP
MUS-POD02	4 person booth	£2250

	Overall width	Overall depth	Overall height	Seat width	Seat depth	Seat height	Back width	Back height
MUS-POD02	2250	1295	1270	1200	490	450	1190	850



MFC FINISHES



White

FABRIC OPTIONS



Grey Seats / Blue
SG-CB



Black Seats / Grey
K-SG

MTO SEATING

TASK SEATING FAMILIES



PERFORMANCE
364



ERGONOMIC
368



TASK
368

MULTI-PURPOSE FAMILIES



CHAIRS & STOOLS
398



SOFT SEATING



LOUNGE
428



SOFAS
440



MODULAR
446



BOOTHS
466



A woman with short dark hair, wearing a dark long-sleeved top, a light-colored scarf, and dark pants, is sitting in a black office chair. She is positioned at a white desk with two laptops. The background shows a modern office environment with white cubicle walls and various plants. The entire image has a light green tint.

MTO TASK SEATING

SYNCHRONISED CUSTOMABILITY
AND COMFORT



KURA
364



MIKU
368



ORTHO PRO SERIES
372



TEGAN
376



KACEY
380



VIRGIL
382



SENZA
384



JOTA
388



ALTINO
392

KURA

PERFORMANCE TASK SEATING

The Kura mesh back task chair comes in a variety of forms, allowing customisation to your requirements. Select from a range of arm types and optional headrest depending on the ergonomic requirements of the user. Kura's breathable mesh back, depth and height adjusting lumbar and soft, padded seat ensure comfort for prolonged periods.



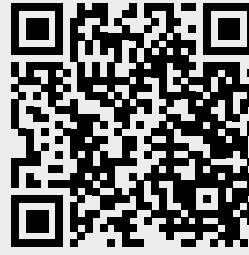

5 Product warranty

 Designed & manufactured

Complies to
BS EN 1335-1
BS EN 1335-2
BS EN 9241-5
BS 5459-2



MTO TASK CHAIR

Mesh



Mesh with Arms



Mesh Exec



Synchro - Weight Balanced Mechanism

CODE	Fabric bands				
	A	B	C	D	E
MESH BACK					
KUK10 No arms	£575	£595	£615	£655	£695

CODE	Fabric bands				
	A	B	C	D	E
MESH BACK					
KUK13 3D arms	£675	£695	£715	£755	£795
KUK14 4D arms	£700	£720	£740	£780	£820

CODE	Fabric bands				
	A	B	C	D	E
MESH BACK					
KUK22 2D arms	£780	£800	£820	£860	£900

DIMENSIONS

Overall width **680**
 Overall depth **600**
 Overall height **990-1110**
 Seat width **480**
 Seat depth **530**
 Seat height **480-600**
 Back width **470**
 Back height **570**

FEATURES

Gas lift adjustment
 Synchro weight balancing mechanism
 Back tilt with 3 locking positions
 Single level control
 Lumbar depth & height adjustment
 Seat depth adjustment
 60mm twin wheel castor
 Black nylon 5 star base
 Optional seat border

DIMENSIONS

Overall width **680**
 Overall depth **600**
 Overall height **990-1110**
 Seat width **480**
 Seat depth **530**
 Seat height **480-600**
 Back width **470**
 Back height **570**

FEATURES

Gas lift adjustment
 Synchro weight balancing mechanism
 Back tilt with 3 locking positions
 Single level control
 Lumbar depth & height adjustment
 Seat depth adjustment
 3D or 4D armrests
 60mm twin wheel castor
 Black nylon 5 star base
 Optional seat border

DIMENSIONS

Overall width **680**
 Overall depth **600**
 Overall height **990-1110**
 Seat width **480**
 Seat depth **530**
 Seat height **480-600**
 Back width **470**
 Back height **570**

FEATURES

Gas lift adjustment
 Synchro weight balancing mechanism
 Back tilt with 3 locking positions
 Single level control
 Lumbar depth & height adjustment
 Seat depth adjustment
 2D armrests with aluminium support
 60mm twin wheel castor
 Polished aluminium 5 star base
 Optional seat border

EXTRAS



Aluminium base
+£45

FABRIC OPTIONS



Contrasting side panels

Please specify extras when ordering

Mesh with Headrest



Mesh with Headrest



Exec with Headrest



Synchro - Weight Balanced Mechanism

CODE	Fabric bands				
	A	B	C	D	E
MESH BACK WITH HEADREST					
KUKH10 No arms	£675	£695	£715	£755	£795

DIMENSIONS
 Overall width **680**
 Overall depth **600**
 Overall height **1200-1320**
 Seat width **480**
 Seat depth **530**
 Seat height **480-600**
 Back width **470**
 Back height **570**

FEATURES
 Gas lift adjustment
 Synchro weight balancing mechanism
 Back tilt with 3 locking positions
 Single level control
 Lumbar depth & height adjustment
 Seat depth adjustment
 60mm twin wheel castor
 Black nylon 5 star base
 Optional seat border
 Headrest with mesh finish

EXTRAS



Aluminium base
+£45

CODE	Fabric bands				
	A	B	C	D	E
MESH BACK WITH HEADREST					
KUKH13 3D arms	£775	£795	£815	£855	£895
KUKH14 4D arms	£800	£820	£840	£880	£920

DIMENSIONS
 Overall width **680**
 Overall depth **600**
 Overall height **1200-1320**
 Seat width **480**
 Seat depth **530**
 Seat height **480-600**
 Back width **470**
 Back height **570**

FEATURES
 Gas lift adjustment
 Synchro weight balancing mechanism
 Back tilt with 3 locking positions
 Single level control
 Lumbar depth & height adjustment
 Seat depth adjustment
 3D or 4D armrests
 60mm twin wheel castor
 Black nylon 5 star base
 Optional seat border
 Headrest with mesh finish

FABRIC OPTIONS



Contrasting side panels

CODE	Fabric bands				
	A	B	C	D	E
MESH BACK WITH HEADREST KUK10					
KUKH22 2D arms	£820	£840	£860	£900	£940

DIMENSIONS
 Overall width **680**
 Overall depth **600**
 Overall height **1200-1320**
 Seat width **480**
 Seat depth **530**
 Seat height **480-600**
 Back width **470**
 Back height **570**

FEATURES
 Gas lift adjustment
 Synchro weight balancing mechanism
 Back tilt with 3 locking positions
 Single level control
 Lumbar depth & height adjustment
 Seat depth adjustment
 2D armrests with aluminium support
 60mm twin wheel castor
 Polished aluminium 5 star base
 Optional seat border
 Headrest with mesh finish

MIKU

PERFORMANCE TASK SEATING

Crafted using cutting-edge technology, Miku is designed to meet the intense demands of the modern workplace. The task chair is a crucial element of any office space, and Miku's ergonomics, adjustability, and intelligent weight-balancing mechanism combine for a truly tailored seating experience for optimal productivity.





5 Product warranty

 Designed & manufactured

BS EN 1335-1
BS EN 1335-2
BS EN 9241-5
BS 5459-2



Fabric

Fabric with Headrest

Fabric Exec

Fabric Exec with Headrest



Synchro - Weight Balanced Mechanism

CODE	Fabric bands				
	A	B	C	D	E
FABRIC BACK NO HEADREST					
MKF10 no arms	£600	£620	£640	£680	£720
MKF13 3D arms	£700	£720	£740	£780	£820
MKF14 4D arms	£720	£740	£760	£800	£840

CODE	Fabric bands				
	A	B	C	D	E
FABRIC BACK WITH HEADREST					
MKFH10 no arms	£700	£720	£740	£780	£820
MKFH13 3D arms	£800	£820	£840	£880	£920
MKFH14 4D arms	£820	£840	£860	£900	£940

CODE	Fabric bands				
	A	B	C	D	E
FABRIC BACK NO HEADREST					
MKF22 2D arms	£750	£770	£790	£830	£870

CODE	Fabric bands				
	A	B	C	D	E
FABRIC BACK WITH HEADREST					
MKFH22 2D arms	£850	£870	£890	£930	£970

DIMENSIONS

Overall width **680**
 Overall depth **600**
 Overall height **1020-1220**
 Seat width **480**
 Seat depth **450-520**
 Seat height **450-570**
 Back width **450**
 Back height **570-650**

FEATURES

Gas lift adjustment
 Synchro weight balancing mechanism
 Back tilt with 3 locking positions
 Single level control
 Back height ratchet adjustable
 Seat depth adjustment
 2D armrests with aluminium support
 60mm twin wheel castor
 Black nylon 5 star base
 Optional seat border

DIMENSIONS

Overall width **680**
 Overall depth **600**
 Overall height **1210-1410**
 Seat width **480**
 Seat depth **450-520**
 Seat height **450-570**
 Back width **450**
 Back height **570-650**

FEATURES

Gas lift adjustment
 Synchro weight balancing mechanism
 Back tilt with 3 locking positions
 Single level control
 Back height ratchet adjustable
 Seat depth adjustment
 2D armrests with aluminium support
 60mm twin wheel castor
 Black nylon 5 star base
 Optional seat border

DIMENSIONS

Overall width **680**
 Overall depth **600**
 Overall height **1020-1220**
 Seat width **480**
 Seat depth **450-520**
 Seat height **450-570**
 Back width **450**
 Back height **570-650**

FEATURES

Gas lift adjustment
 Synchro weight balancing mechanism
 Back tilt with 3 locking positions
 Single level control
 Back height ratchet adjustable
 Seat depth adjustment
 2D armrests with aluminium support
 60mm twin wheel castor
 Polished aluminium 5 star base
 Optional contrast fabric
 Optional seat & backrest border

DIMENSIONS

Overall width **680**
 Overall depth **600**
 Overall height **1210-1410**
 Seat width **480**
 Seat depth **450-520**
 Seat height **450-570**
 Back width **450**
 Back height **570-650**

FEATURES

Gas lift adjustment
 Synchro weight balancing mechanism
 Back tilt with 3 locking positions
 Single level control
 Back height ratchet adjustable
 Seat depth adjustment
 2D armrests with aluminium support
 60mm twin wheel castor
 Polished aluminium 5 star base
 Optional contrast fabric
 Optional seat & backrest border

EXTRAS



Lumbar support
+£35



Aluminium base
+£45

FABRIC OPTIONS



Two tone fabrics



Contrasting side panels

Mesh



Mesh with Headrest



Mesh Exec



Mesh Exec with Headrest



Synchro - Weight Balanced Mechanism

CODE	Fabric bands				
	A	B	C	D	E
MESH BACK NO HEADREST					
MKM10 no arms	£580	£600	£620	£660	£700
MKM13 3D arms	£680	£700	£720	£760	£800
MKM14 4D arms	£700	£720	£740	£780	£820

DIMENSIONS
 Overall width **680**
 Overall depth **600**
 Overall height **1020-1220**
 Seat width **480**
 Seat depth **450-520**
 Seat height **450-570**
 Back width **450**
 Back height **570-650**

FEATURES
 Gas lift adjustment
 Synchro weight balancing mechanism
 Back tilt with 3 locking positions
 Single level control
 Back height ratchet adjustable
 Seat depth adjustment
 No arms, 3D or 4D armrests
 60mm twin wheel castor
 Black nylon 5 star base
 Optional seat border

CODE	Fabric bands				
	A	B	C	D	E
MESH BACK WITH HEADREST					
MKMH10 no arms	£680	£700	£720	£760	£800
MKMH13 3D arms	£780	£800	£820	£860	£900
MKMH14 4D arms	£800	£820	£840	£880	£920

DIMENSIONS
 Overall width **680**
 Overall depth **600**
 Overall height **1210-1410**
 Seat width **480**
 Seat depth **450-520**
 Seat height **450-570**
 Back width **450**
 Back height **570-650**

FEATURES
 Gas lift adjustment
 Synchro weight balancing mechanism
 Back tilt with 3 locking positions
 Single level control
 Back height ratchet adjustable
 Seat depth adjustment
 No arms, 3D or 4D armrests
 60mm twin wheel castor
 Black nylon 5 star base
 Optional seat border

CODE	Fabric bands				
	A	B	C	D	E
MESH BACK NO HEADREST					
MKM22 2D arms	£750	£770	£790	£830	£870

DIMENSIONS
 Overall width **680**
 Overall depth **600**
 Overall height **1020-1220**
 Seat width **480**
 Seat depth **450-520**
 Seat height **450-570**
 Back width **450**
 Back height **570-650**

FEATURES
 Gas lift adjustment
 Synchro weight balancing mechanism
 Back tilt with 3 locking positions
 Single level control
 Back height ratchet adjustable
 Seat depth adjustment
 2D armrests with aluminium support
 60mm twin wheel castor
 Polished aluminium 5 star base
 Optional seat border

CODE	Fabric bands				
	A	B	C	D	E
MESH BACK WITH HEADREST					
MKMH22 2D arms	£850	£870	£890	£930	£970

DIMENSIONS
 Overall width **680**
 Overall depth **600**
 Overall height **1210-1410**
 Seat width **480**
 Seat depth **450-520**
 Seat height **450-570**
 Back width **450**
 Back height **570-650**

FEATURES
 Gas lift adjustment
 Synchro weight balancing mechanism
 Back tilt with 3 locking positions
 Single level control
 Back height ratchet adjustable
 Seat depth adjustment
 2D armrests with aluminium support
 60mm twin wheel castor
 Polished aluminium 5 star base
 Optional contrast fabric
 Optional seat & backrest border

EXTRAS



Aluminium base
+£45

FABRIC OPTIONS



Contrasting side panels

Please specify extras and fabrics options when ordering

ORTHO PRO SERIES

ERGONOMIC TASK SEATING

Ortho Pro is a series of 3 chairs designed to offer maximum ergonomic design and support improved posture in the office and at home. The series offers 3 different back designs to suit a wide range of body shapes and sizes. A wide range of optional extras can be added to ensure perfect alignment of the spine, hips and shoulders.



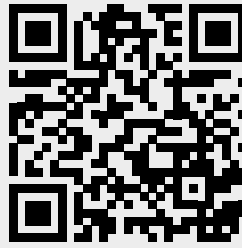

5 Product warranty

 Designed & manufactured

Complies to
EN1335-1:2000
EN1335-2:2009
BS 5459-2:2000+A2:2008



MTO TASK CHAIR

500 Series

600 Series

600 Series with Headrest

700 Series



Asynchro Mechanism

CODE	Fabric bands				
	A	B	C	D	E
OP500 No arms	£450	£500	£550	£600	£650
OP501 4D arms	£525	£575	£625	£675	£725

CODE	Fabric bands				
	A	B	C	D	E
OP600 No arms	£500	£550	£600	£650	£700
OP601 4D arms	£575	£625	£675	£725	£775

CODE	Fabric bands				
	A	B	C	D	E
OPH600 No arms	£600	£650	£700	£750	£800
OPH601 4D arms	£675	£725	£775	£825	£875

CODE	Fabric bands				
	A	B	C	D	E
OP700 No arms	£550	£600	£650	£700	£750
OP701 4D arms	£625	£675	£725	£775	£825



Plastic back with fabric front



Full Fabric back



Full Fabric back with headrest



Full Fabric back

DIMENSIONS

Overall width **648** (with arms **686**)
 Overall depth **648**
 Overall height **952-1187**
 Seat width **533**
 Seat depth **432-483**
 Seat height **470-559**
 Back width **470**
 Back height **570-635**

FEATURES

Gas lift adjustment
 Heavy duty mechanism
 Back height adjustment
 Seat depth adjustment
 Back rake adjustment
 Weight tension control
 Independent seat tilt

ARMS

4d adjustable
 2 dimensional arm pad
 Soft PU arm pad

DIMENSIONS

Overall width **648** (with arms **686**)
 Overall depth **648**
 Overall height **920-1155**
 Seat width **533**
 Seat depth **432-483**
 Seat height **450-565**
 Back width **470**
 Back height **530-615**

FEATURES

Gas lift adjustment
 Heavy duty mechanism
 Back height adjustment
 Seat depth adjustment
 Back rake adjustment
 Weight tension control
 Independent seat tilt

ARMS

4d adjustable
 2 dimensional arm pad
 Soft PU arm pad

DIMENSIONS

Overall width **648** (with arms **686**)
 Overall depth **648**
 Overall height **920-1359**
 Seat width **533**
 Seat depth **432-483**
 Seat height **450-565**
 Back width **470**
 Back height **690-755**

FEATURES

Gas lift adjustment
 Heavy duty mechanism
 Back height adjustment
 Seat depth adjustment
 Back rake adjustment
 Weight tension control
 Independent seat tilt
 Height adjustable headrest

ARMS

4d adjustable
 2 dimensional arm pad
 Soft PU arm pad

DIMENSIONS

Overall width **648** (with arms **686**)
 Overall depth **648**
 Overall height **1168-1333**
 Seat width **533**
 Seat depth **432-483**
 Seat height **450-565**
 Back width **470**
 Back height **690-755**

FEATURES

Gas lift adjustment
 Heavy duty mechanism
 Back height adjustment
 Seat depth adjustment
 Back rake adjustment
 Weight tension control
 Independent seat tilt

ARMS

4d adjustable
 2 dimensional arm pad
 Soft PU arm pad

Ergonomic design to improve posture to ensure perfect alignment of the spine, hips and shoulders, reducing the pressure on the lumbar and coccyx areas

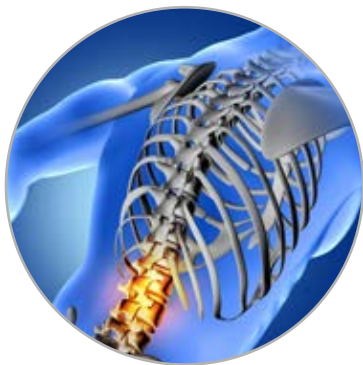

Avoid unnecessary pressure on the spine

Thorax support
Your thoracic spine consists of 12 vertebrae, T1 to T12

Lumbar support
Lower back region of your spinal column or backbone, L1 to L5

Coccyx area
Coccyx option reduces pressure on your coccyx



Optional extras

Please select the required options from the order form



Coccyx cut out £65

Coccyx cut out reduces the pressure applied to the coccyx at the base of the spine while seated. The foam in the area has been replaced with a lower density to relieve pain.



Air release seat £100

For a softer seat release the self inflating air from the seat pad



Inflatable thorax £35

Inflatable thorax supports the spine in the upper back region through ensuring the gap between the thoracic part of the spine and the back is filled.

Inflatable lumbar £35

Inflatable lumbar provides support to the lower back and promotes good ergonomic posture. Inflating the internal lumbar reduces strain on the spine.



Base £45

Polished 5 star base

TEGAN

TASK SEATING

Tegan is an ergonomic and sophisticated seating solution that provides exceptional comfort throughout the working day, whether you are located in the main office or a meeting room. Tegan offers a breathable mesh or fully upholstered back option as an operator chair, 4 leg meeting chair or cantilever frame visitors chair, all with a contoured padded seat and an infinite variety of fabrics to suit every design direction.



Complies to
BS EN1335-1:2020
BS EN1335-2:2018





MTO TASK CHAIR

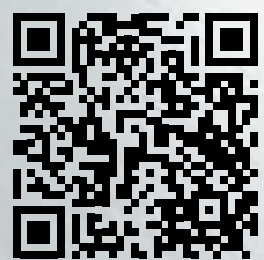

Mesh 200 Series



Fabric 200 Series



Mesh 100 Series



Fabric 100 Series



Synchronised Mechanism

Permanent contact mechanism

CODE	Fabric bands				
	A	B	C	D	E
MESH BACK					
TGM20-000 No arms	£363	£373	£383	£414	£435
TGM21-000 2D arms	£425	£435	£446	£466	£487
TGM22-000 3D arms	£446	£456	£466	£487	£508

CODE	Fabric bands				
	A	B	C	D	E
FABRIC BACK NO HEADREST					
TGF20-000 No arms	£336	£349	£361	£375	£400
TGF21-000 2D arms	£400	£412	£426	£437	£463
TGF22-000 3D arms	£426	£437	£452	£463	£489

CODE	Fabric bands				
	A	B	C	D	E
FABRIC BACK WITH HEADREST					
TGFH22-000 3D arms	£497	£509	£522	£535	£559

CODE	Fabric bands				
	A	B	C	D	E
MESH BACK					
TGM10-000 No arms	£311	£321	£332	£352	£373
TGM11-000 2D arms	£363	£373	£383	£404	£425
TGM12-000 3D arms	£383	£394	£404	£425	£446

CODE	Fabric bands				
	A	B	C	D	E
FABRIC BACK NO HEADREST					
TGF10-000 No arms	£259	£270	£280	£301	£321
TGF11-000 2D arms	£311	£327	£337	£352	£373
TGF12-000 3D arms	£332	£342	£352	£373	£393

CODE	Fabric bands				
	A	B	C	D	E
FABRIC BACK WITH HEADREST					
TGFH12-000 3D arms	£432	£446	£457	£471	£497

DIMENSIONS
 Overall width 680
 Overall depth 590
 Overall height 1005-1130
 Seat width 480
 Seat depth 475
 Seat height 480-605
 Back width 470
 Back height 525

DIMENSIONS
 Overall width 680
 Overall depth 590
 Overall height 1005-1130 (headrest 1220-1345)
 Seat width 480
 Seat depth 475
 Seat height 480-605
 Back width 470
 Back height 525

DIMENSIONS
 Overall width 680
 Overall depth 590
 Overall height 1005-1130
 Seat width 480
 Seat depth 475
 Seat height 480-605
 Back width 470
 Back height 525

DIMENSIONS
 Overall width 680
 Overall depth 590
 Overall height 1005-1130 (headrest 1220-1345)
 Seat width 480
 Seat depth 475
 Seat height 480-605
 Back width 470
 Back height 525

FEATURES
 Gas lift adjustment
 Back rake adjustment
 Back height ratchet adjustment
 Back tilt with 5 locking positions
 Anti shock back
 User weight tension control

FEATURES
 Gas lift adjustment
 Back rake adjustment
 Back height ratchet adjustment
 Back tilt with 5 locking positions
 Anti shock back
 User weight tension control
 Optional adjustable headrest

FEATURES
 Gas lift adjustment
 Back rake adjustment
 Back height adjustment
 Back lockable in any position
 Optional adjustable headrest

FEATURES
 Gas lift adjustment
 Back rake adjustment
 Back height adjustment by hand wheel
 Back lockable in any position
 Optional adjustable headrest

EXTRAS



Lumbar support
00L +£35



Seat slide
050 +£35



Chrome base
C00 +£45

Combine any options on fabric task seating
 For Lumbar support change code to -00L (+£35), for seat slide change to -050 (+£35), Chrome base replace with -C00 (+£45).
 eg. TGF20-COL Chrome base & Lumbar +£90

Mesh

Fabric

Mesh

Fabric



25mm diameter legs with nylon feet

25mm diameter cantilever frame with glides

CODE	Fabric bands				
	A	B	C	D	E
MESH BACK					
TGM200 Fixed arms	£363	£373	£383	£394	£414

CODE	Fabric bands				
	A	B	C	D	E
FABRIC BACK					
TGF200 Fixed arms	£363	£373	£383	£404	£425

CODE	Fabric bands				
	A	B	C	D	E
MESH BACK					
TGM100 Fixed arms	£321	£332	£342	£352	£363

CODE	Fabric bands				
	A	B	C	D	E
FABRIC BACK					
TGF100 Fixed arms	£321	£332	£342	£352	£363

DIMENSIONS
 Overall width **640**
 Overall depth **550**
 Overall height **930**
 Seat width **420**
 Seat depth **460**
 Seat height **470**
 Back width **440**
 Back height **550**

FEATURES
 25mm diameter frame
 Nylon feet
 Fixed arm rest

DIMENSIONS
 Overall width **640**
 Overall depth **550**
 Overall height **930**
 Seat width **420**
 Seat depth **460**
 Seat height **470**
 Back width **440**
 Back height **550**

FEATURES
 25mm diameter frame
 Nylon feet
 Fixed arm rest

DIMENSIONS
 Overall width **640**
 Overall depth **550**
 Overall height **930**
 Seat width **420**
 Seat depth **460**
 Seat height **470**
 Back width **440**
 Back height **550**

FEATURES
 25mm diameter frame
 Glides on frame
 Fixed arm rest

DIMENSIONS
 Overall width **640**
 Overall depth **550**
 Overall height **930**
 Seat width **420**
 Seat depth **460**
 Seat height **470**
 Back width **440**
 Back height **550**

FEATURES
 25mm diameter frame
 Glides on frame
 Fixed arm rest

KACEY

TASK SEATING

Kacey is the definition of mesh back seating for the modern office and is the perfect chair for those who spend hours sitting at the computer and then quick to change between shifts. Fully public sector approved, Kacey can be adjusted to many positions to suit the unique needs of the user.



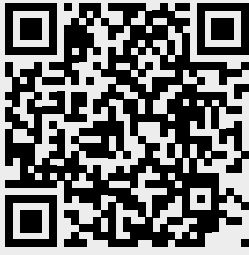

5 Product warranty

 Designed & manufactured

BS EN 1335-1
BS EN 1335-2
BS EN 9241 -5
BS 5459-2



Mesh



Synchronised Weight Balanced Mechanism

CODE	Fabric bands				
	A	B	C	D	E
MESH BACK					
KCY400T1-K 4D arms	£466	£492	£518	£544	£570

DIMENSIONS
 Overall width **635**
 Overall depth **600**
 Overall height **1000-1090**
 Seat width **500**
 Seat depth **500**
 Seat height **460-550**
 Back width **460**
 Back height **560**
 Arm height from floor **600-820**

FEATURES
 Gas lift adjustment
 Weight tension control
 Synchro seat and back lockable
 Integrated seat depth adjustment
 Adjustable lumbar
 Integrated seat slide
 4D adjustable

VIRGIL

TASK SEATING

Virgil chair combines function, comfort, and elegant design. With distinctive silhouette and intelligent controls, it is a user-friendly and intuitive chair that is easily adjusted for instant comfort. Simple lines and fully upholstered finish complement Virgil's ergonomic appeal. Choose arms and you have a fully adjustable arm with movement in four directions.





5 Product warranty

Designed & manufactured

Complies to
BS EN 1335-1
BS EN 1335-2



Fabric



Synchro Weight Balanced Mechanism

CODE	Fabric bands				
	A	B	C	D	E
FABRIC BACK					
VG40-050 No arms	£510	£530	£550	£570	£590
VG46-050 With arms	£550	£570	£590	£610	£630

DIMENSIONS
 Overall width 650
 Overall depth 600
 Overall height 990-1110
 Seat width 520
 Seat depth 480
 Seat height 450-570
 Back width 440
 Back height 550

FEATURES
 Gas lift adjustment
 Weight tension control
 Synchro seat and back lockable
 Seat depth adjustment
 Adjustable lumbar
 Integrated seat slide

EXTRAS



Lumbar support
OSL +£35



Chrome base
CSO +£55

Combine any options on fabric task seating
 For Lumbar support change code to -OSL (+£35)
 Chrome base replace with -CSO (+£55)
 eg. VG400-CSL Chrome base & Lumbar +£90

SENZA

TASK SEATING

Comfort, reliability and affordability are the key attributes of the Senza operator and visitor chairs, with their curvaceous profile and vast array of options that deliver style as well as substance. Equipped with ergonomic features, a high back, extra high back and mesh back options together with draughtsman and visitor chairs, this seating family easily provides the comfort needed for a long day at work.



EN1335-1:2000
EN1335-2:2009
BS 5459-2:2000+A2:2008





MTO TASK CHAIR

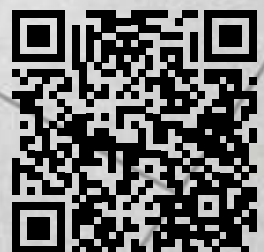

Ergo



Asynchrio or PCB Mechanism

XL



Asynchrio Mechanism

High



Fabric bands					
CODE	A	B	C	D	E
FABRIC BACK					
SXERGOA PCB	£487	£497	£508	£528	£549
SXERGOB Asynchrio	£508	£518	£528	£549	£570

DIMENSIONS
 Overall width 680
 Overall depth 650
 Overall height 1120-1250
 Seat width 520
 Seat depth 500
 Seat height 470-600
 Back width 590
 Back height 590

FEATURES
 Back rake adjustment
 Back height ratchet adjustment
 Weight tension control
 Lumbar support
 Seat depth adjustment
 Independent seat tilt adjustment (SXERGOA only)

Fabric bands					
CODE	A	B	C	D	E
FABRIC BACK					
SX40-000 No arms	£364	£381	£397	£436	£489
SX43-000 Fixed arms	£391	£405	£423	£461	£515
SX44-000 Adjustable arms	£430	£449	£461	£504	£556
SX46-000 Folding arms	£454	£471	£487	£527	£581

DIMENSIONS
 Overall width 680
 Overall depth 650
 Overall height 1050-1180
 Seat width 520
 Seat depth 500
 Seat height 540-670
 Back width 480
 Back height 590

FEATURES
 Gas lift adjustment
 Back rake adjustment
 Back height ratchet adjustment
 Independent seat tilt adjustment

Fabric bands					
CODE	A	B	C	D	E
FABRIC BACK					
SH40-000 No arms	£321	£332	£342	£363	£383
SH43-000 Fixed arms	£342	£352	£363	£383	£404
SH44-000 Adjustable arms	£389	£399	£409	£430	£451
SH46-000 Folding arms	£399	£409	£420	£440	£461

DIMENSIONS
 Overall width 680
 Overall depth 650
 Overall height 970-1100
 Seat width 520
 Seat depth 500
 Seat height 470-600
 Back width 450
 Back height 500

FEATURES
 Gas lift adjustment
 Back rake adjustment
 Back height ratchet adjustment
 Independent seat tilt adjustment

EXTRAS



Lumbar support
00L +£35



Seat slide
050 +£35



Chrome base
C00 +£45

Combine any options on fabric task seating
 For Lumbar support change code to -00L (+£35), for seat slide change to -050 (+£35), Chrome base replace with -C00 (+£45).
 eg. SX44-05L Seat slide & Lumbar +£70

Mesh



Asynchrio Mechanism

CODE	Fabric bands				
	A	B	C	D	E
MESH BACK					
SM40-000 No arms	£327	£337	£347	£358	£368
SM43-000 Fixed arms	£360	£370	£380	£391	£401
SM44-000 Adjustable arms	£396	£406	£417	£427	£437
SM46-000 Folding arms	£423	£433	£443	£454	£464

DIMENSIONS
 Overall width **680**
 Overall depth **650**
 Overall height **1030-1160**
 Seat width **520**
 Seat depth **500**
 Seat height **470-600**
 Back width **480**
 Back height **570**

FEATURES
 Gas lift adjustment
 Back rake adjustment
 Back height ratchet adjustment
 Independent seat tilt adjustment

Draughtsman



CODE	Fabric bands				
	A	B	C	D	E
MESH BACK					
SMD40-000 No arms	£450	£461	£476	£488	£502
SMD43-000 Fixed arms	£475	£487	£501	£514	£528
SMD44-000 Adjustable arms	£500	£512	£526	£538	£552

DIMENSIONS
 Overall width **620**
 Overall depth **550**
 Overall height **1090-1340**
 Seat width **480**
 Seat depth **460**
 Seat height **550-880**
 Back height **530**
 Back width **460**

FEATURES
 Gas lift adjustment
 Back rake adjustment
 Back height adjustment

Visitor



Chrome cantilever frame with arms

CODE	Fabric bands				
	A	B	C	D	E
FABRIC BACK					
SC00-000 Fixed arms	£363	£373	£383	£404	£425

DIMENSIONS
 Overall width **565**
 Overall depth **625**
 Overall height **900**
 Seat width **510**
 Seat depth **490**
 Seat height **440**
 Back width **450**
 Back height **495**

EXTRAS



Lumbar support
00L +£35



Seat slide
0S0 +£35



Chrome base
C00 +£45

Combine options on mesh task seating
 For seat slide change to **-0S0 (+£35)**, Chrome base replace with **-C00 (+£45)**.
 eg. **SM40-CS0** Chrome base & seat slide **+£80**

JOTA

TASK SEATING

Jota has a traditional oval shaped back design in a number of sizes with high density seat and back foam for maximum user comfort. With so many adjustable settings in the fabric, mesh, draughtsman and visitor chairs, the Jota seating family offers the ideal configuration for any hard-working professional, eliminating aches and pains associated with improper support.



EN1335-1:2000
EN1335-2:2009
BS 5459-2:2000+A2:2008



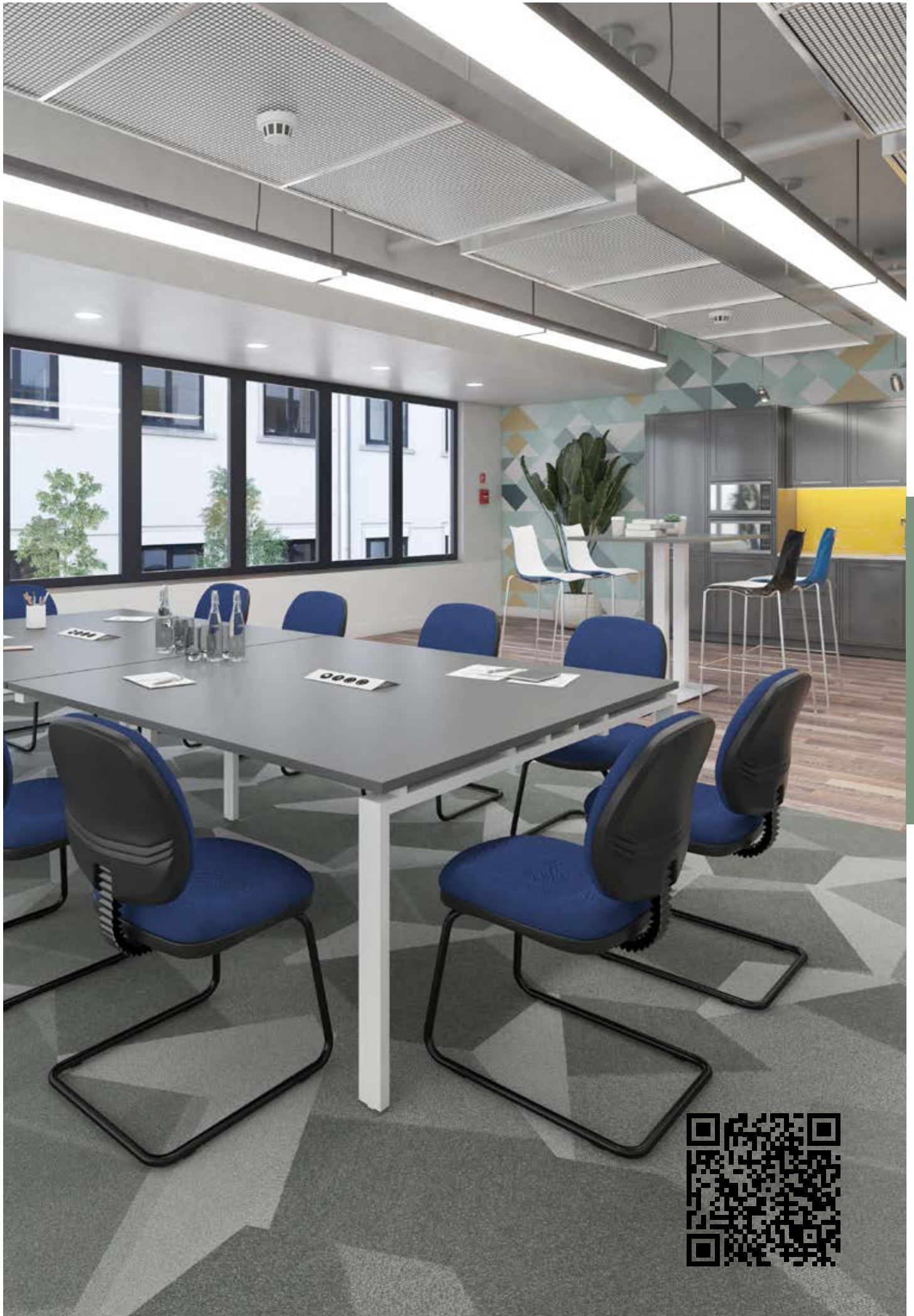

MTO TASK CHAIR

Ergo



Asynchrio or PCB Mechanism

XXL



Asynchro Mechanism

XL



Draughtsman



PCB Mechanism

CODE	Fabric bands				
	A	B	C	D	E
FABRIC BACK					
JXERGOA PCB	£446	£456	£466	£487	£508
JXERGOB Asynchro	£487	£497	£508	£528	£549

CODE	Fabric bands				
	A	B	C	D	E
FABRIC BACK					
JX40-000 No arms	£311	£321	£332	£352	£373
JX43-000 Fixed arms	£337	£347	£358	£378	£399
JX44-000 Adjustable arms	£373	£383	£394	£414	£435
JX46-000 Folding arms	£394	£404	£414	£435	£456

CODE	Fabric bands				
	A	B	C	D	E
FABRIC BACK					
JH40-000 No arms	£290	£301	£311	£332	£352
JH43-000 Fixed arms	£311	£321	£332	£352	£373
JH44-000 Adjustable arms	£352	£363	£373	£394	£414
JH46-000 Folding arms	£373	£383	£394	£414	£435

CODE	Fabric bands				
	A	B	C	D	E
FABRIC BACK					
VD20-000 No arms	£266	£282	£300	£340	£392
VD21-000 Fixed arms	£291	£306	£324	£364	£416
VD22-000 Adjustable arms	£324	£340	£357	£397	£450

CODE	Fabric bands				
	A	B	C	D	E
MESH BACK					
VMD20-000 No arms	£356	£371	£382	£398	£411
VMD21-000 Fixed arms	£423	£434	£451	£462	£479
VMD22-000 Adjustable arms	£454	£469	£482	£497	£509

DIMENSIONS

Overall width **680**
Overall depth **650**
Overall height **1040-1240**
Seat width **520**
Seat depth **500**
Seat height **470-600**
Back width **500**
Back height **590**

FEATURES

Gas lift adjustment
Back rake adjustment
Back height ratchet adjustment
Weight tension control
Lumbar support
Seat depth adjustment
Independent seat tilt adjustment (JXERGOA only)

DIMENSIONS

Overall width **680**
Overall depth **650**
Overall height **970-1170**
Seat width **520**
Seat depth **500**
Seat height **440-560**
Back width **480**
Back height **590**

FEATURES

Gas lift adjustment
Back rake adjustment
Back height ratchet adjustment
Independent seat tilt adjustment

EXTRAS



Lumbar support
00L +£35



Seat slide
050 +£35



Chrome base
C00 +£45

DIMENSIONS

Overall width **680**
Overall depth **650**
Overall height **940-1140**
Seat width **520**
Seat depth **500**
Seat height **440-560**
Back width **450**
Back height **510**

FEATURES

Gas lift adjustment
Back rake adjustment
Back height ratchet adjustment
Independent seat tilt adjustment

DIMENSIONS

Overall width **670**
Overall depth **600**
Overall height **990-1260**
Seat width **470**
Seat depth **450**
Seat height **590-860**
Back width **420**
Back height **400**

FEATURES

Gas lift adjustment
Back rake adjustment
Back height adjustment
Folding back rest
Foot ring

Combine any options on fabric task seating
For Lumbar support change code to **-00L (+£35)**, for seat slide change to **-050 (+£35)**, Chrome base replace with **-C00 (+£45)**.
eg. **JX46-CSL** Chrome base, Seat slide & Lumbar **+£115**

High

Medium

Mesh

Visitor



PCB Mechanism

Frame in black or chrome

CODE	Fabric bands				
	A	B	C	D	E
PCB FABRIC BACK					
VH10-000 No arms	£207	£213	£218	£239	£259
VH11-000 Fixed arms	£228	£233	£239	£259	£280
VH12-000 Adjustable arms	£259	£264	£270	£290	£311

CODE	Fabric bands				
	A	B	C	D	E
FABRIC BACK					
VM10-000 No arms	£197	£202	£207	£228	£249
VM11-000 Fixed arms	£218	£223	£228	£249	£270
VM12-000 Adjustable arms	£249	£254	£259	£280	£301

CODE	Fabric bands				
	A	B	C	D	E
MESH BACK					
VMH10-000 No arms	£259	£264	£270	£290	£311
VMH11-000 Fixed arms	£280	£285	£290	£311	£332
VMH12-000 Adjustable arms	£306	£311	£316	£337	£358

CODE	Fabric bands				
	A	B	C	D	E
BLACK BASE					
VC00-000 No arms	£266	£282	£300	£340	£392
VC01-000 Fixed arms	£291	£306	£324	£364	£416

CODE	Fabric bands				
	A	B	C	D	E
ASYNCHRO FABRIC BACK					
VH20-000 No arms	£223	£228	£233	£254	£275
VH21-000 Fixed arms	£244	£249	£254	£275	£295
VH22-000 Adjustable arms	£275	£280	£285	£306	£327

CODE	Fabric bands				
	A	B	C	D	E
CHROME BASE					
VC00-C00 No arms	£315	£325	£345	£385	£435
VC01-C00 Fixed arms	£335	£350	£365	£415	£460

DIMENSIONS
 Overall width 670
 Overall depth 600
 Overall height 920-1120
 Seat width 470
 Seat depth 450
 Seat height 440-560
 Back width 420
 Back height 530

DIMENSIONS
 Overall width 670
 Overall depth 600
 Overall height 840-960
 Seat width 470
 Seat depth 450
 Seat height 440-560
 Back width 430
 Back height 530

DIMENSIONS
 Overall width 670
 Overall depth 600
 Overall height 870-990
 Seat width 470
 Seat depth 450
 Seat height 440-560
 Back width 430
 Back height 530

DIMENSIONS
 Overall width 670
 Overall depth 605
 Overall height 880
 Seat width 470
 Seat depth 450
 Seat height 480
 Back width 420
 Back height 400

FEATURES
 Gas lift adjustment
 Back rake adjustment
 Back height adjustment
 Independent seat tilt adjustment (VH20-22 only)

FEATURES
 Gas lift adjustment
 Back rake adjustment
 Back height adjustment

FEATURES
 Gas lift adjustment
 Back rake adjustment
 Back height adjustment

EXTRAS



Lumbar support
00L +£35



Seat slide
050 +£35



Chrome base
C00 +£45

Combine options on mesh task seating
 For seat slide change to -050 (+£35), Chrome base replace with -C00 (+£45).
 eg. VMH10-CS0 Chrome base & seat slide +£80

ALTINO

TASK SEATING

With its clean, modern styling, Altino is guaranteed to provide a contemporary feel to any office environment, due to the multi functions and ergonomic design of the chair. The sculptured moulded foam seat combines with the breathable slimline mesh back or fabric back options, to keep users cool and comfortable in any office or meeting environment.



Product
warranty



Designed &
manufactured

EN1335-1:2000,
EN1335-2:2009
BS 5459-2:2000+A2:2008





MTO TASK CHAIR

Ergo



Asynchrio or PCB Mechanism

XL



Asynchro Mechanism

High



High



PCB Mechanism

CODE	Fabric bands				
	A	B	C	D	E
FABRIC BACK					
AXERGOA PCB	£471	£487	£501	£532	£608
AXERGOB Asynchro	£501	£520	£532	£561	£638

CODE	Fabric bands				
	A	B	C	D	E
FABRIC BACK					
LH40-000 No arms	£259	£270	£280	£301	£321
LH43-000 Fixed arms	£285	£295	£306	£327	£347
LH44-000 Adjustable arms	£321	£332	£342	£363	£383
LH46-000 Folding arms	£342	£352	£363	£383	£404

CODE	Fabric bands				
	A	B	C	D	E
FABRIC BACK					
TH20-000 No arms	£239	£249	£259	£280	£301
TH21-000 Fixed arms	£259	£270	£280	£301	£321
TH22-000 Adjustable arms	£290	£301	£311	£332	£352

CODE	Fabric bands				
	A	B	C	D	E
FABRIC BACK					
TH10-000 No arms	£223	£233	£244	£264	£285
TH11-000 Fixed arms	£244	£254	£264	£285	£306
TH12-000 Adjustable arms	£275	£285	£295	£316	£337

DIMENSIONS

Overall width 680
Overall depth 650
Overall height 1060-1180
Seat width 520
Seat depth 500
Seat height 470-600
Back width 500
Back height 590

FEATURES

Gas lift adjustment
Back rake adjustment
Back height ratchet adjustment
Weight tension control
Lumbar support
Seat depth adjustment
Independent seat tilt adjustment (AXERGOA only)

DIMENSIONS

Overall width 680
Overall depth 650
Overall height 1020-1140
Seat width 520
Seat depth 500
Seat height 440-560
Back width 450
Back height 550

FEATURES

Gas lift adjustment
Back rake adjustment
Back height ratchet adjustment
Independent seat tilt adjustment

DIMENSIONS

Overall width 670
Overall depth 600
Overall height 990-1110
Seat width 470
Seat depth 450
Seat height 440-560
Back width 430
Back height 500

FEATURES

Gas lift adjustment
Back rake adjustment
Back height adjustment
Independent seat tilt adjustment

DIMENSIONS

Overall width 670
Overall depth 600
Overall height 990-1110
Seat width 470
Seat depth 450
Seat height 440-560
Back width 430
Back height 400

FEATURES

Gas lift adjustment
Back rake adjustment
Back height adjustment

EXTRAS



Lumbar support
00L +£35



Seat slide
050 +£35



Chrome base
C00 +£45

Combine any options on fabric task seating
For Lumbar support change code to -00L (+£35), for seat slide change to -050 (+£35), Chrome base replace with -C00 (+£45).
LH40-COL Chrome base & Lumbar +£80

Draughtsman



PCB mechanism

Mesh



Asynchro Mechanism

Mesh



PCB mechanism

Visitor



Frame in black or chrome

CODE	Fabric bands				
	A	B	C	D	E
MESH BACK					
AHD10-000 No arms	£311	£316	£321	£332	£352
AHD11-000 Fixed arms	£332	£337	£342	£352	£373
AHD12-000 Adjustable arms	£363	£368	£373	£383	£404

CODE	Fabric bands				
	A	B	C	D	E
MESH BACK					
AH20-000 No arms	£270	£275	£280	£290	£311
AH21-000 Fixed arms	£290	£295	£301	£311	£332
AH22-000 Adjustable arms	£321	£327	£332	£342	£363

CODE	Fabric bands				
	A	B	C	D	E
MESH BACK					
AH10-000 No arms	£249	£254	£259	£270	£280
AH11-000 Fixed arms	£270	£275	£280	£290	£311
AH12-000 Adjustable arms	£301	£306	£311	£321	£342

CODE	Fabric bands				
	A	B	C	D	E
BLACK BASE					
AC00-000 No arms	£290	£295	£301	£311	£332
AC01-000 Fixed arms	£311	£316	£321	£332	£352

CODE	Fabric bands				
	A	B	C	D	E
CHROME BASE					
AC00-C00 No arms	£337	£342	£347	£358	£378
AC01-C00 Fixed arms	£358	£363	£368	£378	£399

DIMENSIONS
 Overall width 670
 Overall depth 600
 Overall height 1090-1340
 Seat width 470
 Seat depth 450
 Seat height 550-800
 Back width 460
 Back height 530

FEATURES
 Gas lift adjustment
 Back rake adjustment
 Back height adjustment
 Chrome foot ring

DIMENSIONS
 Overall width 670
 Overall depth 600
 Overall height 970-1090
 Seat width 470
 Seat depth 450
 Seat height 440-560
 Back width 430
 Back height 530

FEATURES
 Gas lift adjustment
 Back rake adjustment
 Back height adjustment
 Independent seat tilt adjustment

DIMENSIONS
 Overall width 670
 Overall depth 600
 Overall height 970-1090
 Seat width 470
 Seat depth 450
 Seat height 440-560
 Back width 430
 Back height 530

FEATURES
 Gas lift adjustment
 Back rake adjustment
 Back height adjustment

DIMENSIONS
 Overall width 670
 Overall depth 605
 Overall height 880
 Seat width 470
 Seat depth 450
 Seat height 480
 Back width 430
 Back height 530

EXTRAS



Lumbar support
00L +£35



Seat slide
050 +£35



Chrome base
C00 +£45

Combine options on mesh task seating
 For seat slide change to -050 (+£35), Chrome base replace with -C00 (+£45).
 eg. AH20-C50 Chrome base & seat slide +£80



MTO MULTI-PURPOSE

ELEVATE YOUR SEATING POTENTIAL



LACEY
398



TUBA FABRIC
402



TUBA MESH
406



SANTANA
408



TAURUS
416



CODA
418



VERVE
419



DART
420



TAMAR
420



FUNDAMENTAL
421



STRUT
422



HARMONY
424



REMY
425



ROSCOE
425

LACEY

MULTI-PURPOSE

A versatile sleek chair designed for the modern workplace, a great addition to meeting rooms, collaborative areas, and focused spaces. The combination of a light external shell with supportive mesh back, integral arms and an upholstered waterfall fronted seat pad, ensure that Lacey provides on both style and substance.

Functionality, ergonomics, and comfort are the key benefits of the chair, ensuring that the user can work to the best of their ability. Using three different base options to transform from a traditional meeting chair to a 'light' task chair.



Designed & manufactured

Complies to
BS EN 16139:2013 Level 1





MTO MULTI-PURPOSE

Lacey | Multi-Purpose Seating Family

Cantilever



CODE	Fabric bands				
	A	B	C	D	E
BLACK BASE					
LCY01-K	£430	£450	£470	£510	£550
WHITE BASE					
LCY01-WH	£430	£450	£470	£510	£550

DIMENSIONS
 Overall width **620**
 Overall depth **600**
 Overall height **915**
 Seat width **460**
 Seat depth **510**
 Seat height **430**
 Back width **515**
 Back height **435**

FEATURES
 Black mesh back
 Integrated arms
 Optional black & white frame

Pyramid Base



CODE	Fabric bands				
	A	B	C	D	E
BLACK BASE					
LCY02-K	£430	£450	£470	£510	£550
WHITE BASE					
LCY02-WH	£430	£450	£470	£510	£550

DIMENSIONS
 Overall width **620**
 Overall depth **600**
 Overall height **915**
 Seat width **460**
 Seat depth **510**
 Seat height **430**
 Back width **515**
 Back height **435**

FEATURES
 Black mesh back
 Mobile swivel base
 Integrated arms
 Optional black & white frame

FRAME COLOURS



Black

White

Pyramid Mobile



CODE	Fabric bands				
	A	B	C	D	E
BLACK BASE					
LCY03-K	£475	£495	£515	£555	£595
WHITE BASE					
LCY03-WH	£475	£495	£515	£555	£595

DIMENSIONS
 Overall width **620**
 Overall depth **600**
 Overall height **915**
 Seat width **460**
 Seat depth **510**
 Seat height **430**
 Back width **515**
 Back height **435**

FEATURES
 Black mesh back
 4 Star pyramid base
 Integrated arms
 Optional black & white frame

Swivel



CODE	Fabric bands				
	A	B	C	D	E
BLACK BASE					
LCY04-K	£475	£495	£515	£555	£595

DIMENSIONS
 Overall width **620**
 Overall depth **600**
 Overall height **915**
 Seat width **460**
 Seat depth **510**
 Seat height **430**
 Back width **515**
 Back height **435**

FEATURES
 Black mesh back
 5 Star black nylon base
 Tilt mechanism

FRAME COLOURS



Black

White



Black

TUBA FABRIC

MULTI-PURPOSE

Tuba is a handsomely upholstered conference room chair that looks as luxurious as it feels. The fully upholstered seat is available with a full back, half back or a half mesh back, with 4 leg, swivel pyramid base or cantilever frame options, so Tuba will bring the perfect blend of comfort and style to any boardroom, meeting room, conference room or visitor seating.



3 Product warranty



Designed & manufactured

**Complies to
BS EN 16139:2013
Level 1 110kg**



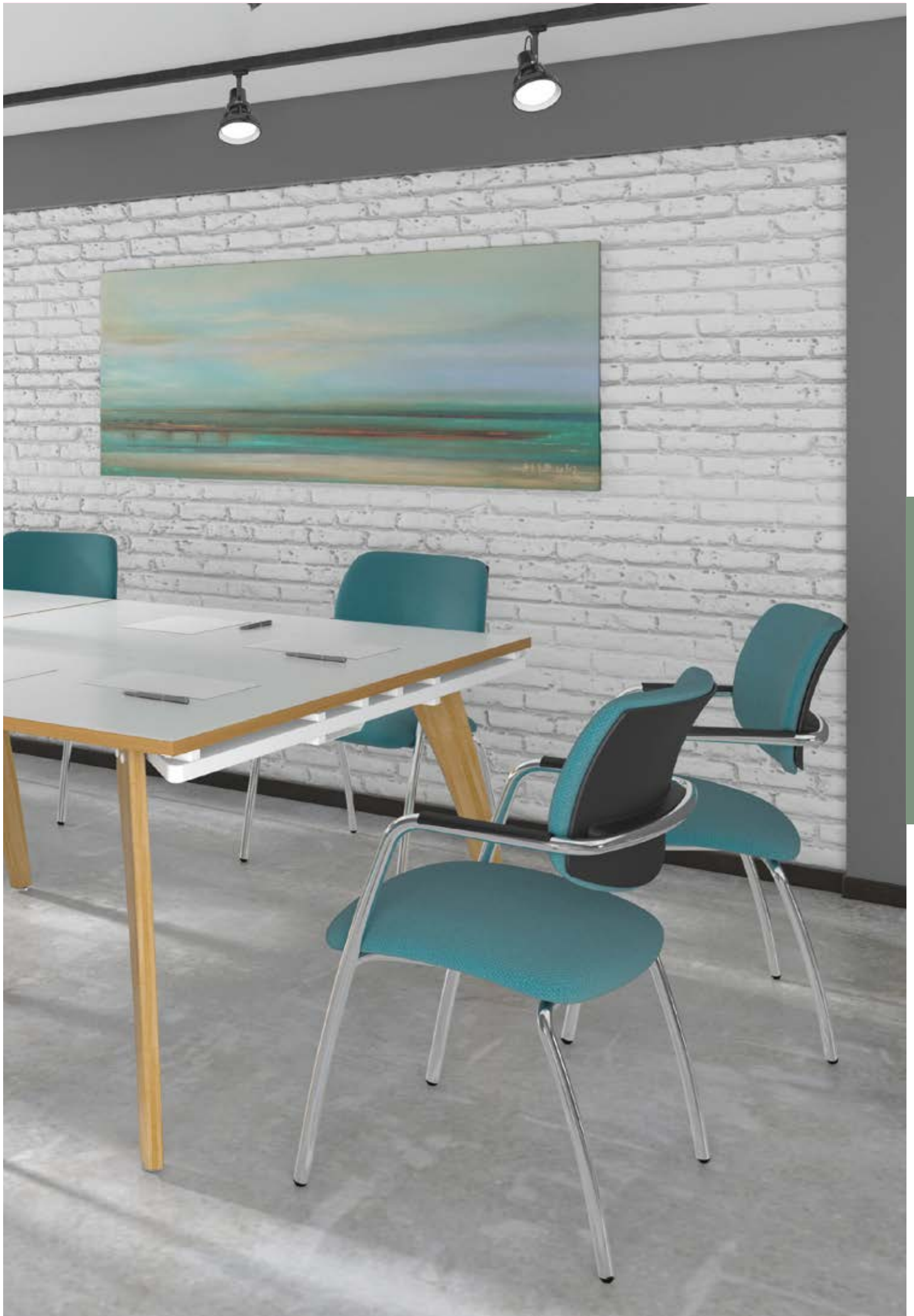

MTO MULTI-PURPOSE

Tuba | Multi-Purpose Seating Family

Cantilever Frame

4 Leg Frame

Pyramid Base

Pyramid Mobile



CODE	Fabric bands				
	A	B	C	D	E
CHROME BASE					
TUB100C1-C	£249	£259	£270	£290	£311

CODE	Fabric bands				
	A	B	C	D	E
CHROME BASE					
TUB104C1-C	£249	£259	£270	£290	£311

CODE	Fabric bands				
	A	B	C	D	E
WHITE BASE					
TUB102C1-WH	£352	£363	£373	£394	£414

CODE	Fabric bands				
	A	B	C	D	E
WHITE BASE					
TUB103C1-WH	£383	£394	£404	£425	£466

BLACK BASE					
TUB100C1-K	£249	£259	£270	£290	£311

BLACK BASE					
TUB104C1-K	£249	£259	£270	£290	£311

BLACK BASE					
TUB102C1-K	£352	£363	£373	£394	£414

BLACK BASE					
TUB103C1-K	£383	£394	£404	£425	£466

DIMENSIONS
 Overall width 550
 Overall depth 620
 Overall height 845
 Seat width 500
 Seat depth 460
 Seat height 440
 Back width 440
 Back height 330

DIMENSIONS
 Overall width 550
 Overall depth 620
 Overall height 845
 Seat width 500
 Seat depth 460
 Seat height 440
 Back width 440
 Back height 330

DIMENSIONS
 Overall width 550
 Overall depth 620
 Overall height 845
 Seat width 500
 Seat depth 460
 Seat height 440
 Back width 440
 Back height 330

DIMENSIONS
 Overall width 550
 Overall depth 620
 Overall height 845
 Seat width 500
 Seat depth 460
 Seat height 440
 Back width 440
 Back height 330

FEATURES
 Fixed arms
 Stackable (up to 6 high)

FEATURES
 Fixed arms
 Stackable (up to 6 high)

FEATURES
 Fixed arms
 Pyramid style base

FEATURES
 Fixed arms
 Pyramid style mobile base

FRAME COLOURS

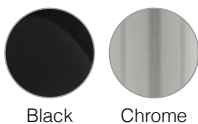

Black

Chrome



Black

White

Tuba | Multi-Purpose Seating Family

Cantilever Frame



4 Leg Frame



Pyramid Base



Pyramid Mobile



CODE	Fabric bands				
	A	B	C	D	E
CHROME BASE					
TUB200C1-C	£270	£280	£290	£311	£332

CODE	Fabric bands				
	A	B	C	D	E
BLACK BASE					
TUB200C1-K	£270	£280	£290	£311	£332

CODE	Fabric bands				
	A	B	C	D	E
CHROME BASE					
TUB204C1-C	£259	£270	£280	£301	£321

CODE	Fabric bands				
	A	B	C	D	E
BLACK BASE					
TUB204C1-K	£259	£270	£280	£301	£321

CODE	Fabric bands				
	A	B	C	D	E
WHITE BASE					
TUB202C1-WH	£373	£383	£394	£414	£435

CODE	Fabric bands				
	A	B	C	D	E
BLACK BASE					
TUB202C1-K	£373	£383	£394	£414	£435

CODE	Fabric bands				
	A	B	C	D	E
WHITE BASE					
TUB203C1-WH	£404	£414	£425	£446	£466

CODE	Fabric bands				
	A	B	C	D	E
BLACK BASE					
TUB203C1-K	£404	£414	£425	£446	£466

DIMENSIONS
 Overall width 550
 Overall depth 620
 Overall height 930
 Seat width 500
 Seat depth 460
 Seat height 440
 Back width 440
 Back height 550

FEATURES
 Fixed arms
 Stackable (up to 6 high)

DIMENSIONS
 Overall width 550
 Overall depth 620
 Overall height 930
 Seat width 500
 Seat depth 460
 Seat height 440
 Back width 440
 Back height 550

FEATURES
 Fixed arms
 Stackable (up to 6 high)

DIMENSIONS
 Overall width 550
 Overall depth 620
 Overall height 930
 Seat width 500
 Seat depth 460
 Seat height 440
 Back width 440
 Back height 550

FEATURES
 Fixed arms
 Pyramid style base

DIMENSIONS
 Overall width 550
 Overall depth 620
 Overall height 930
 Seat width 500
 Seat depth 460
 Seat height 440
 Back width 440
 Back height 550

FEATURES
 Fixed arms
 Pyramid style mobile base

FRAME COLOURS

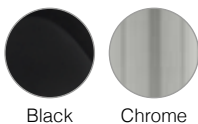

Black

Chrome



Black

White

TUBA MESH

MULTI-PURPOSE

The tuba family is designed for multiple uses, a versatile chair that adapts to different types of environments. Ideal for contract projects, for furnishing a range of rooms in professional environments, for business or office meetings and conferences, and look great in domestic environments. Tuba mesh back has elegant and simple lines that give it a modern touch. The frame is available in black with base options in chrome, black or white configurations and a comfortable seat that can be upholstered in a wide range of fabrics



**Complies to
BS EN 16139:2013
Level 1 110kg**



Cantilever Frame

4 Leg Frame

Pyramid Base

Pyramid Mobile



CODE	Fabric bands				
	A	B	C	D	E
CHROME BASE					
TUB300C1-C	£270	£280	£290	£311	£332

CODE	Fabric bands				
	A	B	C	D	E
CHROME BASE					
TUB304C1-C	£270	£280	£290	£311	£332

CODE	Fabric bands				
	A	B	C	D	E
WHITE BASE					
TUB302C1-WH	£363	£373	£383	£404	£425

CODE	Fabric bands				
	A	B	C	D	E
WHITE BASE					
TUB303C1-WH	£383	£394	£404	£425	£446

BLACK BASE					
CODE	A	B	C	D	E
TUB300C1-K	£270	£280	£290	£311	£332

BLACK BASE					
CODE	A	B	C	D	E
TUB304C1-K	£270	£280	£290	£311	£332

BLACK BASE					
CODE	A	B	C	D	E
TUB302C1-K	£363	£373	£383	£404	£425

BLACK BASE					
CODE	A	B	C	D	E
TUB303C1-K	£383	£394	£404	£425	£446

DIMENSIONS
 Overall width **550**
 Overall depth **620**
 Overall height **845**
 Seat width **500**
 Seat depth **460**
 Seat height **440**
 Back width **440**
 Back height **330**

DIMENSIONS
 Overall width **550**
 Overall depth **620**
 Overall height **845**
 Seat width **500**
 Seat depth **460**
 Seat height **440**
 Back width **440**
 Back height **330**

DIMENSIONS
 Overall width **550**
 Overall depth **620**
 Overall height **845**
 Seat width **500**
 Seat depth **460**
 Seat height **440**
 Back width **440**
 Back height **330**

DIMENSIONS
 Overall width **550**
 Overall depth **620**
 Overall height **845**
 Seat width **500**
 Seat depth **460**
 Seat height **440**
 Back width **440**
 Back height **330**

FEATURES
 Fixed arms with cushioned pads
 Stackable (up to 6 high)

FEATURES
 Fixed arms with cushioned pads
 Stackable (up to 6 high)

FEATURES
 Fixed arms with cushioned pads
 Pyramid style base

FEATURES
 Fixed arms with cushioned pads
 Pyramid style mobile base

FRAME COLOURS

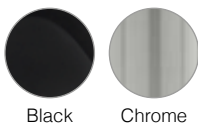

Black

Chrome

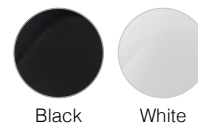

Black

White

SANTANA

MULTI-PURPOSE

Santana offers strong and durable seating options that are both stylish and practical. The angled lines of these meeting room chairs create an unpretentious, contemporary look that blends well with just about any office design. Santana is available in black and grey shells, with numerous upholstered seating and frame options so people can relax and sit in comfort.



Complies to
BS EN 16139:2013
Level 1 110kg





4 Leg



4 leg Mobile



Cantilever



CODE	Fabric bands				
	A	B	C	D	E
BLACK FOUR LEG STACKING CHAIR					
SFU100-K No arms	£252	£265	£290	£309	£323
SFU101-K Fixed arms	£291	£305	£330	£350	£363
SFU102-K Writing tablet	£333	£345	£372	£391	£402

CODE	Fabric bands				
	A	B	C	D	E
BLACK FOUR LEG MOBILE CHAIR					
SFU200-K No arms	£284	£309	£323	£336	£349
SFU201-K Fixed arms	£324	£350	£363	£376	£389
SFU202-K Writing tablet	£364	£377	£391	£423	£434

CODE	Fabric bands				
	A	B	C	D	E
BLACK CANTILEVER CHAIR					
SFU300-K No arms	£304	£323	£336	£349	£375
SFU301-K Fixed arms	£343	£363	£376	£399	£414
SFU302-K Writing tablet	£382	£402	£416	£429	£454

CODE	Fabric bands				
	A	B	C	D	E
CHROME FOUR LEG STACKING CHAIR					
SFU100-C No arms	£252	£265	£290	£309	£323
SFU101-C Fixed arms	£291	£305	£330	£350	£363
SFU102-C Writing tablet	£333	£345	£372	£391	£402

CODE	Fabric bands				
	A	B	C	D	E
CHROME FOUR LEG MOBILE CHAIR					
SFU200-C No arms	£284	£309	£323	£336	£349
SFU201-C Fixed arms	£324	£350	£363	£376	£389
SFU202-C Writing tablet	£364	£377	£391	£423	£434

CODE	Fabric bands				
	A	B	C	D	E
CHROME CANTILEVER CHAIR					
SFU300-C No arms	£304	£323	£336	£349	£375
SFU301-C Fixed arms	£343	£363	£376	£399	£414
SFU302-C Writing tablet	£382	£402	£416	£429	£454

DIMENSIONS
 Overall width 500
 Overall depth 530
 Overall height 790
 Seat width 460
 Seat depth 430
 Seat height 440
 Back width 430
 Back height 380

DIMENSIONS
 Overall width 580
 Overall depth 530
 Overall height 790
 Seat width 460
 Seat depth 430
 Seat height 440
 Back width 430
 Back height 380

DIMENSIONS
 Overall width 600
 Overall depth 730
 Overall height 820
 Seat width 460
 Seat depth 430
 Seat height 440
 Back width 430
 Back height 380

FEATURES
 Stackable (up to 8 high)
 (not writing tablet)

FEATURES
 Stackable (up to 8 high)
 (not writing tablet)

SHELL COLOURS



Black Shell (-K)



Grey Shell (-G)

4 leg

4 Leg Mobile

Cantilever



Fabric bands					
CODE	A	B	C	D	E
BLACK FOUR LEG STACKING CHAIR					
SMB100-K No arms	£241	£252	£272	£284	£299
SMB101-K Fixed arms	£280	£291	£313	£324	£338
SMB102-K Writing tablet	£319	£333	£352	£364	£377

Fabric bands					
CODE	A	B	C	D	E
BLACK FOUR LEG MOBILE CHAIR					
SMB200-K No arms	£284	£299	£309	£342	£356
SMB201-K Fixed arms	£324	£338	£350	£381	£396
SMB202-K Writing tablet	£364	£377	£391	£423	£434

Fabric bands					
CODE	A	B	C	D	E
BLACK CANTILEVER CHAIR					
SMB300-K No arms	£299	£309	£323	£342	£356
SMB301-K Fixed arms	£338	£350	£363	£381	£396
SMB302-K Writing tablet	£377	£391	£402	£423	£434

Fabric bands					
CODE	A	B	C	D	E
CHROME FOUR LEG STACKING CHAIR					
SMB100-C No arms	£241	£252	£272	£284	£299
SMB101-C Fixed arms	£280	£291	£313	£324	£338
SMB102-C Writing tablet	£319	£333	£352	£364	£377

Fabric bands					
CODE	A	B	C	D	E
CHROME FOUR LEG MOBILE CHAIR					
SMB200-C No arms	£284	£299	£309	£342	£356
SMB201-C Fixed arms	£324	£338	£350	£381	£396
SMB202-C Writing tablet	£364	£377	£391	£423	£434

Fabric bands					
CODE	A	B	C	D	E
CHROME CANTILEVER CHAIR					
SMB300-C No arms	£299	£309	£323	£342	£356
SMB301-C Fixed arm	£338	£350	£363	£381	£396
SMB302-C Writing tablet	£377	£391	£402	£423	£434

DIMENSIONS
 Overall width 500
 Overall depth 530
 Overall height 790
 Seat width 460
 Seat depth 430
 Seat height 440
 Back width 430
 Back height 380

FEATURES
 Stackable (up to 8 high)
 (not writing tablet)

DIMENSIONS
 Overall width 580
 Overall depth 530
 Overall height 790
 Seat width 460
 Seat depth 430
 Seat height 440
 Back width 430
 Back height 380

DIMENSIONS
 Overall width 600
 Overall depth 730
 Overall height 820
 Seat width 460
 Seat depth 430
 Seat height 440
 Back width 430
 Back height 380

FEATURES
 Stackable (up to 8 high)
 (not writing tablet)

SHELL COLOURS



Black Shell (-K)



Grey Shell (-G)

4 leg



4 Leg Mobile



Cantilever



CODE	Fabric bands				
	A	B	C	D	E
BLACK FOUR LEG STACKING CHAIR					
SUP100-K No arms	£232	£246	£259	£284	£309
SUP101-K Fixed arms	£275	£286	£300	£324	£350
SUP102-K Writing tablet	£314	£325	£339	£364	£391

CODE	Fabric bands				
	A	B	C	D	E
BLACK FOUR LEG MOBILE CHAIR					
SUP200-K No arms	£272	£284	£299	£323	£349
SUP201-K Fixed arms	£313	£324	£338	£363	£389
SUP202-K Writing tablet	£352	£364	£377	£402	£429

CODE	Fabric bands				
	A	B	C	D	E
BLACK CANTILEVER CHAIR					
SUP300-K No arms	£284	£299	£309	£336	£361
SUP301-K Fixed arms	£324	£338	£350	£376	£401
SUP302-K Writing tablet	£364	£377	£391	£416	£441

CODE	Fabric bands				
	A	B	C	D	E
CHROME FOUR LEG STACKING CHAIR					
SUP100-C No arms	£232	£246	£259	£284	£309
SUP101-C Fixed arms	£275	£286	£300	£324	£350
SUP102-C Writing tablet	£314	£325	£339	£364	£391

CODE	Fabric bands				
	A	B	C	D	E
CHROME FOUR LEG MOBILE CHAIR					
SUP200-C No arms	£272	£284	£299	£323	£349
SUP201-C Fixed arms	£313	£324	£338	£363	£383
SUP202-C Writing tablet	£352	£364	£377	£402	£429

CODE	Fabric bands				
	A	B	C	D	E
CHROME CANTILEVER CHAIR					
SUP300-C No arms	£284	£299	£309	£336	£361
SUP301-C Fixed arms	£324	£338	£350	£376	£401
SUP302-C Writing tablet	£364	£377	£391	£416	£441

DIMENSIONS
 Overall width 500
 Overall depth 530
 Overall height 790
 Seat width 460
 Seat depth 430
 Seat height 440
 Back width 430
 Back height 380

DIMENSIONS
 Overall width 580
 Overall depth 530
 Overall height 790
 Seat width 460
 Seat depth 430
 Seat height 440
 Back width 430
 Back height 380

DIMENSIONS
 Overall width 600
 Overall depth 730
 Overall height 820
 Seat width 460
 Seat depth 430
 Seat height 440
 Back width 430
 Back height 380

FEATURES
 Stackable (up to 6 high)
 (not writing tablet)

FEATURES
 Stackable (up to 6 high)
 (not writing tablet)

SHELL COLOURS



Black Shell (-K)



Grey Shell (-G)

4 leg



CODE	RRP
BLACK FOUR LEG STACKING CHAIR	
SPB100-K No arms	£230
SPB101-K Fixed arms	£275
SPB102-K Writing tablet	£300

CODE	RRP
CHROME FOUR LEG STACKING CHAIR	
SPB100-C No arms	£230
SPB101-C Fixed arms	£275
SPB102-C Writing tablet	£300

DIMENSIONS
 Overall width **500**
 Overall depth **530**
 Overall height **790**
 Seat width **460**
 Seat depth **430**
 Seat height **440**
 Back width **430**
 Back height **380**

FEATURES
 Stackable (up to 6 high)
 (not writing tablet)

4 Leg Mobile



CODE	RRP
BLACK FOUR LEG MOBILE CHAIR	
SPB200-K No arms	£275
SPB201-K Fixed arms	£300
SPB202-K Writing tablet	£350

CODE	RRP
CHROME FOUR LEG MOBILE CHAIR	
SPB200-C No arms	£275
SPB201-C Fixed arms	£300
SPB202-C Writing tablet	£350

DIMENSIONS
 Overall width **580**
 Overall depth **530**
 Overall height **790**
 Seat width **460**
 Seat depth **430**
 Seat height **440**
 Back width **430**
 Back height **380**

Cantilever



CODE	RRP
BLACK CANTILEVER CHAIR	
SPB300-K No arms	£300
SPB301-K Fixed arms	£340
SPB302-K Writing tablet	£380

CODE	RRP
CHROME CANTILEVER CHAIR	
SPB300-C No arms	£300
SPB301-C Fixed arms	£340
SPB302-C Writing tablet	£380

DIMENSIONS
 Overall width **600**
 Overall depth **730**
 Overall height **820**
 Seat width **460**
 Seat depth **430**
 Seat height **440**
 Back width **430**
 Back height **380**

FEATURES
 Stackable (up to 6 high)
 (not writing tablet)

SHELL COLOURS



Black Shell (-K)



Grey Shell (-G)

2 seater



CODE **RRP**
 BENCH WITH 2 SEATS
 SPB-B2 **£600**

2 Seater with Table



CODE **RRP**
 BENCH WITH 2 SEATS AND TABLE
 SPB-B3T **£750**

3 Seater



CODE **RRP**
 BENCH WITH 3 SEATS
 SPB-B3 **£790**

3 Seater with Table



CODE **RRP**
 BENCH WITH 3 SEATS AND TABLE
 SPB-B4T **£1100**

4 Seater



CODE **RRP**
 BENCH WITH 4 SEATS
 SPB-B4 **£1100**

DIMENSIONS

Overall width 2 wide **1000**, 3 wide **1450**, 4 wide **1900**
 Overall depth **600**
 Overall height **760**
 Seat width **460**
 Seat depth **430**
 Seat height **450**
 Back width **430**
 Back height **380**

SHELL COLOURS



Black Shell (-K)



Grey Shell (-G)



MTO MULTI-PURPOSE



No arms

Arms

Tablet



Fabric bands

CODE	A	B	C	D	E
BLACK FRAME					
TAU40002	£150	£180	£210	£240	£270

CHROME FRAME					
TAU40005	£160	£190	£220	£250	£280

DIMENSIONS

Overall width **530** (With arms **640**, Tablet **590**)
 Overall depth **540**
 Overall height **835**
 Seat width **470**
 Seat depth **440**
 Seat height **450**
 Back width **460**
 Back height **340**

FEATURES

Stackable up to 6 high
 Chrome & black frame
 Complies to BS EN16139:2013 Level 1

Fabric bands

CODE	A	B	C	D	E
BLACK FRAME					
TAU40003	£200	£230	£260	£290	£320

CHROME FRAME					
TAU40006	£210	£240	£270	£300	£330

DIMENSIONS

Overall width **530** (With arms **640**, Tablet **590**)
 Overall depth **540**
 Overall height **835**
 Seat width **470**
 Seat depth **440**
 Seat height **450**
 Back width **460**
 Back height **340**

FEATURES

Stackable up to 6 high
 Chrome & black frame
 Complies to BS EN16139:2013 Level 1

Fabric bands

CODE	A	B	C	D	E
BLACK FRAME					
TAU40004	£210	£240	£270	£300	£330

CHROME FRAME					
TAU40007	£220	£250	£280	£310	£340

DIMENSIONS

Overall width **530** (With arms **640**, Tablet **590**)
 Overall depth **540**
 Overall height **835**
 Seat width **470**
 Seat depth **440**
 Seat height **450**
 Back width **460**
 Back height **340**

FEATURES

Writing tablet
 Chrome & black frame
 Complies to BS EN16139:2013 Level 1



Bench Fabric



Bench Plastic



MTO MULTI-PURPOSE

Fabric bands					
CODE	A	B	C	D	E
2 SEATS					
TAU-P-B2	£461	£476	£488	£502	£556
3 SEATS					
TAU-U-B3	£582	£598	£626	£665	£718
2 SEATS AND TABLE					
TAU-U-B3T	£610	£626	£652	£678	£731
4 SEATS					
TAU-U-B4	£813	£840	£867	£908	£974
3 SEATS AND TABLE					
TAU-U-B4T	£840	£867	£894	£936	£1000

DIMENSIONS
 Overall width **1000** (3 wide 1450, 4 wide 1900)
 Overall depth **600**
 Overall height **760**
 Seat width **470**
 Seat depth **440**
 Seat height **450**
 Back width **460**
 Back height **340**

CODE	RRP
2 SEATS	
TAU-P-B2	£383
3 SEATS	
TAU-P-B3	£466
2 SEATS AND TABLE	
TAU-P-B3T	£508
4 SEATS	
TAU-P-B4	£621
3 SEATS AND TABLE	
TAU-P-B4T	£684

DIMENSIONS
 Overall width **1000** (3 wide 1450, 4 wide 1900)
 Overall depth **600**
 Overall height **760**
 Seat width **470**
 Seat depth **440**
 Seat height **450**
 Back width **460**
 Back height **340**



No arms

Arms



Fabric bands

CODE	A	B	C	D	E
NO ARMS					
COD100H	£193	£211	£223	£241	£275

DIMENSIONS
 Overall width **580** (No arms **490**)
 Overall depth **570**
 Overall height **930**
 Seat width **440**
 Seat depth **470**
 Seat height **480**
 Back width **450**
 Back height **380**

FEATURES
 Durable chrome frame
 Stackable up to 4 high

Fabric bands

CODE	A	B	C	D	E
FIXED ARMS					
COD101H	£223	£241	£258	£275	£316

DIMENSIONS
 Overall width **580** (No arms **490**)
 Overall depth **570**
 Overall height **930**
 Seat width **440**
 Seat depth **470**
 Seat height **480**
 Back width **450**
 Back height **380**

FEATURES
 Durable chrome frame
 Arm supports
 Stackable up to 4 high



4 Leg Base



CODE	RRP
CHROME 4 LEG	
VRV504C	£244

DIMENSIONS
 Overall width **520**
 Overall depth **510**
 Overall height **810**
 Seat width **420**
 Seat depth **440**
 Seat height **450**
 Back width **420**
 Back height **360**

FEATURES
 Chrome frame
 Stackable up to 16 high
 Complies to BS EN16139:2013

Sled Base



CODE	RRP
CHROME SLED	
VRV501C	£216

DIMENSIONS
 Overall width **520**
 Overall depth **510**
 Overall height **810**
 Seat width **420**
 Seat depth **440**
 Seat height **450**
 Back width **420**
 Back height **360**

FEATURES
 Chrome sled frame
 Stackable up to 16 high
 Complies to BS EN16139:2013

SHELL COLOURS



Black
K

Blue
BL



Dart

Dart Arms

Tamar

Tamar Arms



Fabric bands					Fabric bands						
CODE	A	B	C	D	E	CODE	A	B	C	D	E
NO ARMS					FIXED ARMS						
DAR50001	£250	£266	£300	£324	£357	DAR50004	£250	£266	£300	£324	£357

Fabric bands					Fabric bands						
CODE	A	B	C	D	E	CODE	A	B	C	D	E
NO ARMS					FIXED ARMS						
TAM50001	£364	£381	£397	£416	£456	TAM50004	£404	£425	£440	£471	£492

DIMENSIONS
 Overall width **520**
 Overall depth **600**
 Overall height **850**
 Seat width **450**
 Seat depth **510**
 Seat height **460**
 Back width **390**
 Back height **320**

DIMENSIONS
 Overall width **520**
 Overall depth **600**
 Overall height **850**
 Seat width **450**
 Seat depth **510**
 Seat height **460**
 Back width **390**
 Back height **320**

FEATURES
 Half upholstered back
 Beech laminate frame
 Stackable up to 4 high
 Optional arms
 Complies to BS EN16139:2013 Level 1

FEATURES
 Half upholstered back
 Beech laminate frame
 Stackable up to 4 high
 Optional arms
 Complies to BS EN16139:2013 Level 1

DIMENSIONS
 Overall width **580**
 Overall depth **540**
 Overall height **820**
 Seat width **500**
 Seat depth **470**
 Seat height **460**
 Back width **500**
 Back height **480**

DIMENSIONS
 Overall width **580**
 Overall depth **540**
 Overall height **820**
 Seat width **500**
 Seat depth **470**
 Seat height **460**
 Back width **500**
 Back height **480**

FEATURES
 Fully upholstered back
 Beech laminate frame
 Stackable up to 4 high
 Optional arms

FEATURES
 Fully upholstered back
 Beech laminate frame
 Stackable up to 4 high
 Optional arms



Wood Chair



CODE	RRP
BEECH SEAT & BACK	
CH2012-B-C	£197

DIMENSIONS
 Overall width **530**
 Overall depth **560**
 Overall height **870**
 Seat width **530**
 Seat depth **560**
 Seat height **450**
 Back width **350**
 Back height **430**

FEATURES
 Wood formed seat
 Chrome frame
 Stackable up to 8 high

Upholstered Chair



CODE	Fabric bands				
	A	B	C	D	E
BEECH BACK & UPHOLSTERED SEAT					
CH2012-BUS-C	£233	£254	£274	£275	£295

FULLY UPHOLSTERED					
CH2012-F-C	£275	£290	£311	£363	£414

DIMENSIONS
 Overall width **530**
 Overall depth **560**
 Overall height **870**
 Seat width **530**
 Seat depth **560**
 Seat height **450**
 Back width **350**
 Back height **430**

FEATURES
 Wood formed seat
 Upholstery options seat only & fully upholstered
 Chrome frame
 Stackable up to 8 high

Wood Stool



CODE	RRP
BEECH SEAT & BACK	
HS2010-B-C	£247

DIMENSIONS
 Overall width **515**
 Overall depth **550**
 Overall height **1050**
 Seat width **515**
 Seat depth **550**
 Seat height **750**
 Back width **350**
 Back height **430**

FEATURES
 Wood formed seat
 Chrome frame
 Foot rest
 Stackable up to 6 high

Upholstered Stool



CODE	Fabric bands				
	A	B	C	D	E
BEECH BACK & UPHOLSTERED SEAT					
HS2010-BUS-C	£290	£311	£332	£352	£373

FULLY UPHOLSTERED					
HS2010-F-C	£311	£332	£352	£373	£394

DIMENSIONS
 Overall width **515**
 Overall depth **550**
 Overall height **1050**
 Seat width **515**
 Seat depth **550**
 Seat height **750**
 Back width **350**
 Back height **430**

FEATURES
 Wood formed seat
 Upholstery options seat only & fully upholstered
 Chrome frame
 Foot rest
 Stackable up to 6 high



Chrome Sled

Chrome 4 Leg

Natural Oak



Fabric bands

CODE	A	B	C	D	E
UPHOLSTERED					
STR501C	£363	£383	£394	£404	£425

CODE	RRP
CHROME SLED FRAME	
STR501C	£261

DIMENSIONS
 Overall width 450 (Sled 480)
 Overall depth 510 (Sled 530)
 Overall height 850
 Seat width 440
 Seat depth 380
 Seat height 450
 Back width 400
 Back height 380

FEATURES
 One piece chair shell
 3 base options
 Upholstered seat pads
 6 Plastic colour options
 Complies to BS EN16139:2013 Level 1

Fabric bands

CODE	A	B	C	D	E
UPHOLSTERED					
STR502C	£363	£383	£394	£404	£425

CODE	RRP
CHROME 4 LEG	
STR502C	£261

DIMENSIONS
 Overall width 450 (Sled 480)
 Overall depth 510 (Sled 530)
 Overall height 850
 Seat width 440
 Seat depth 380
 Seat height 450
 Back width 400
 Back height 380

Fabric bands

CODE	A	B	C	D	E
UPHOLSTERED					
STR502C	£373	£394	£404	£414	£435

CODE	RRP
NATURAL OAK	
STR504W	£266

DIMENSIONS
 Overall width 450 (Sled 480)
 Overall depth 510 (Sled 530)
 Overall height 850
 Seat width 440
 Seat depth 380
 Seat height 450
 Back width 400
 Back height 380

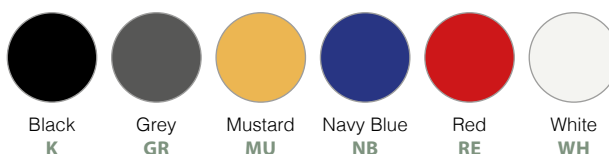

Please add shell colour followed by SP when ordering e.g. STR504W-WH-SP



Chrome Sled

Natural Oak



Fabric bands

CODE	A	B	C	D	E
UPHOLSTERED					
STR601C	£414	£435	£456	£466	£482

Fabric bands

CODE	A	B	C	D	E
UPHOLSTERED					
STR604W	£436	£451	£462	£476	£488

CODE	RRP
CHROME SLED FRAME	
STR601C	£311

CODE	RRP
NATURAL OAK LEGS	
STR604W	£374

DIMENSIONS
 Overall width **450** (Sled **480**)
 Overall depth **510** (Sled **530**)
 Overall height **1060**
 Seat width **440**
 Seat depth **380**
 Seat height **710**
 Back width **400**
 Back height **380**

DIMENSIONS
 Overall width **450** (Sled **480**)
 Overall depth **510** (Sled **530**)
 Overall height **1060**
 Seat width **440**
 Seat depth **380**
 Seat height **710**
 Back width **400**
 Back height **380**

FEATURES

- One piece chair shell
- 2 base options
- Upholstered seat option
- Foot rests
- 6 Plastic colour options
- Complies to BS EN16139:2013 Level 2

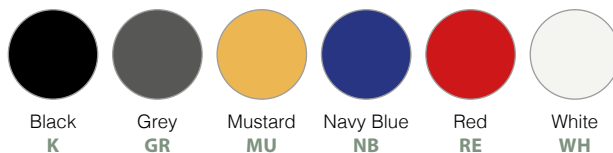

Please add shell colour followed by SP when ordering e.g. STR601C-WH-SP



Chair Chrome

Chair Black

Stool Chrome



CODE	Fabric bands				
	A	B	C	D	E
UPHOLSTERED					
HRM504C	£275	£298	£319	£341	£384

CODE	RRP
CHROME 4 LEG	
HRM504C	£199

DIMENSIONS
 Overall width 550
 Overall depth 520
 Overall height 830
 Seat width 550
 Seat depth 520
 Seat height 480
 Back width 550
 Back height 350

FEATURES
 One piece chair shell
 4 Plastic colour options
 Perforated back design
 Optional upholstered seat pad
 Black and chrome chair base

CODE	Fabric bands				
	A	B	C	D	E
UPHOLSTERED					
HRM504K	£275	£298	£319	£341	£384

CODE	RRP
BLACK 4 LEG	
HRM504K	£199

DIMENSIONS
 Overall width 550
 Overall depth 520
 Overall height 830
 Seat width 550
 Seat depth 520
 Seat height 480
 Back width 550
 Back height 350

CODE	Fabric bands				
	A	B	C	D	E
UPHOLSTERED					
HRM509C-SP	£412	£439	£462	£484	£522 £593

CODE	RRP
CHROME SLED FRAME	
HRM509C	£293

DIMENSIONS
 Overall width 550
 Overall depth 520
 Overall height 1160
 Seat width 550
 Seat depth 520
 Seat height 800
 Back width 550
 Back height 350



Black RAL9005 **K** Blue RAL5014 **BL** Grey RAL7003 **GR** Orange RAL2003 **OR**

Please add shell colour followed by **SP** when ordering e.g. **HRM504C-BL-SP**



Remy Metal

Remy Wood

Roscoe Metal

Roscoe Wood



CODE	Fabric bands				
	A	B	C	D	E
NO ARMS					
REM-HS-CS	£479	£510	£543	£574	£637
FIXED ARMS					
REM-HSA-CS	£574	£606	£637	£669	£733

CODE	Fabric bands				
	A	B	C	D	E
NO ARMS					
REM-HS	£701	£733	£764	£796	£828
FIXED ARMS					
REM-HSA	£796	£828	£860	£891	£925

DIMENSIONS
 Overall width 460
 Overall depth 470
 Overall height 940
 Seat width 410
 Seat depth 380
 Seat height 770
 Back width 390
 Back height 190

DIMENSIONS
 Overall width 410
 Overall depth 470
 Overall height 940
 Seat width 410
 Seat depth 380
 Seat height 770
 Back width 390
 Back height 190

FEATURES
 Complies to BS EN16139:2013 Level 1

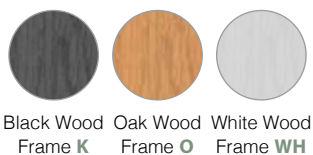

Black Wood Frame K Oak Wood Frame O White Wood Frame WH

Please add frame colour when ordering e.g. **REM-HS-K**

CODE	Fabric bands				
	A	B	C	D	E
NO ARMS					
ROS02-HS	£416	£448	£479	£510	£543
FIXED ARMS					
ROS02-HSA	£448	£479	£510	£543	£574

CODE	Fabric bands				
	A	B	C	D	E
NO ARMS					
ROS01-HS	£701	£733	£764	£796	£828
FIXED ARMS					
ROS01-HS	£764	£796	£828	£860	£891

DIMENSIONS
 Overall width 530
 Overall depth 480
 Overall height 1100
 Seat width 430
 Seat depth 370
 Seat height 760
 Back width 450
 Back height 340

DIMENSIONS
 Overall width 530
 Overall depth 480
 Overall height 1100
 Seat width 430
 Seat depth 370
 Seat height 760
 Back width 450
 Back height 340

FEATURES
 Complies to BS EN16139:2013 Level 1

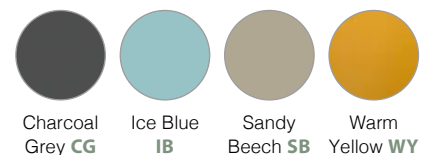

Charcoal Grey CG Ice Blue IB Sandy Beech SB Warm Yellow WY

Please add shell colour when ordering e.g. **ROS02-HSA-CG**



MTO
SOFT SEATING
CREATE EXTRAORDINARY SPACES



JUNA
428



JUDE
430



OTIS
432



SHOUT
434



CELESTRA
436



GROOVE
438



OSLO
440



MEAVY
442



YEALM
444



ALTO
446



LYRIC
448



LYRIC MODULAR
450



ALBAN
452



NERA
454



ENCORE SOFAS
458



ENCORE² MODULAR
460

JUNA

LOUNGE CHAIRS

Beautifully crafted and elegant in design, Juna offers an informal refuge for employees and visitors alike. The Juna chairs offer an exceptional level of comfort and are smartly sized to make a big impression, even in small spaces. This comfortable lounge chair can help soothe your stresses and fatigues caused by work with its warm embrace and entertain your guests with its ergonomic design.



Product warranty



Designed & manufactured



Specification

	Overall width	Overall depth	Overall height	Seat width	Seat depth	Seat height	Back width	Back height
JUN01	700	770	1000	510	490	460	570	600
JUN02	620	570	870	470	440	460	570	450

Juna | Lounge Chairs

Traditionally styled, smart, angular soft seating design with smooth curves

Wooden legs & polished aluminium rotating base options

Ergonomically-designed lines with comfortable back & arm support

Ideal around a coffee table in a reception or waiting area for visitors



Fabric bands					
CODE	A	B	C	D	E
HIGH BACK CHAIR WITH 4 STAR BASE					
JUN01-AR	£800	£850	£900	£950	£1050



Fabric bands					
CODE	A	B	C	D	E
HIGH BACK CHAIR WITH WOODEN LEGS					
JUN01-WF	£850	£900	£950	£1000	£1100



Fabric bands					
CODE	A	B	C	D	E
LOW BACK CHAIR WITH 4 STAR BASE					
JUN02-AR	£750	£800	£850	£950	£1050



Fabric bands					
CODE	A	B	C	D	E
LOW BACK CHAIR WITH WOODEN LEGS					
JUN02-WF	£800	£850	£900	£950	£1050

MTO SOFT SEATING

MTO



4-5 week lead time

JUDE

LOUNGE CHAIRS

Jude lounge seating's practical details make it both eye-catching and timeless. With its base options and clean styling, Jude can seamlessly cross the line between classic and contemporary, with an opulent, curved design and arms that wrap the occupant in one continuous embrace. A classic form that combines exquisite design in a fashion format, Jude is the perfect signature piece to reside in public spaces.



Product warranty



Designed & manufactured



Specification

	Overall width	Overall depth	Overall height	Seat width	Seat depth	Seat height	Back width	Back height
JUD03	600	620	760	510	490	420	460	320
JUD05	600	620	760	510	490	420	460	320
JUD06	600	620	780	510	490	440	460	320
JUD07	600	620	780	510	490	440	460	320

Juna | Lounge Chairs

Contemporary design with luxurious deep-foamed seat for added comfort

Purposefully designed sculptured back and arms section

Ideal for receptions, waiting rooms and breakout areas around a table

Choice of distinctive leg bases and mobile base options



Fabric bands

CODE	A	B	C	D	E
LOUNGE CHAIR WITH PYRAMID OAK LEGS					
JUD03	£828	£880	£932	£984	£1035



Fabric bands

CODE	A	B	C	D	E
LOUNGE CHAIR WITH CHROME 4 STAR BASE					
JUD05	£828	£880	£932	£984	£1035



Fabric bands

CODE	A	B	C	D	E
LOUNGE CHAIR WITH CHROME SLEIGH FRAME					
JUD06	£673	£725	£777	£828	£880



Fabric bands

CODE	A	B	C	D	E
LOUNGE CHAIR WITH WHITE PYRAMID BASE & CASTORS					
JUD07-WH	£673	£725	£777	£828	£880



Fabric bands

CODE	A	B	C	D	E
LOUNGE CHAIR WITH BLACK PYRAMID BASE & CASTORS					
JUD07-K	£673	£725	£777	£828	£880

MTO SOFT SEATING

MTO



4-5 week lead time

OTIS

LOUNGE CHAIR & SOFA

With sophisticated design styling, Otis features voluminous curves for a soft and stylish profile. The upholstered tub style chair has angled sides which offer a relaxing and comfortable seating solution and the distinctive, diagonal four-legged chrome frame complements the matching coffee table to perfection.



Product warranty



Designed & manufactured



Specification

	Overall width	Overall depth	Overall height	Seat width	Seat depth	Seat height	Back width	Back height
OTIS01	610	720	800	470	450	450	560	400
OTIS01-CT	600	600	420					
OTIS05	900	720	800	850	450	470		400

Otis | Lounge Chairs & Sofa

Elegant, flowing lines with a durable laminated interior frame

Choose from polished chrome, black and white pyramid base, mobile pyramid base or wooden legs

Comprehensive choice of fabrics with two-tone options

Ideal around a coffee table in a reception or waiting area for visitors



CODE	Fabric bands				
	A	B	C	D	E
LOUNGE CHAIR WITH 4 STAR BASE					
OTIS01	£837	£872	£911	£987	£1063

CODE	Fabric bands				
	A	B	C	D	E
LOUNGE CHAIR WITH 4 STAR BASE					
OTIS02-WH	£673	£725	£777	£828	£880
OTIS02-K	£673	£725	£777	£828	£880

CODE	Fabric bands				
	A	B	C	D	E
LOUNGE CHAIR WITH 4 STAR BASE WITH CASTORS					
OTIS03-WH	£725	£777	£828	£880	£932
OTIS03-K	£725	£777	£828	£880	£932



CODE	Fabric bands				
	A	B	C	D	E
LOUNGE CHAIR WITH WOODEN LEGS					
OTIS04	£880	£932	£984	£1035	£1087

CODE	Fabric bands				
	A	B	C	D	E
2 SEATER SOFA WITH WOODEN LEGS					
OTIS05	£1242	£1294	£1346	£1398	£1449

CODE	RRP
OTIS01-CT	£375
CIRCULAR TABLE	

MTO SOFT SEATING

MTO



MFC FINISHES



White (WH)



Kendal Oak (KO)

SHOUT

LOUNGE CHAIRS

The graceful curves and refined shape of the Shout chairs offer a welcoming place to work casually and comfortably. The chic frame design provides a contoured platform that supports sophistication, with a welcoming seat and two expressive back styles that both combine the pleasure of a warm embrace with a versatility ideal for receptions, breakout spaces, common areas, and meeting rooms.



Specification

	Overall width	Overall depth	Overall height	Seat width	Seat depth	Seat height	Back width	Back height
B5H01	600	600	840	570	490	460	600	470
B5H02	600	600	840	570	490	460	600	470

Shout | Lounge Chairs

Can be placed in reception areas, open spaces, private nooks, and more

Contemporary curved back design with the choice of chrome frames

Two base styles with choice of fabric or solid wooden backs

Ideal around the matching coffee table in a reception or waiting area



CODE	Fabric bands				
	A	B	C	D	E
LOUNGE CHAIR WITH 4 STAR BASE					
BSH01	£673	£725	£777	£828	£880



CODE	Fabric bands				
	A	B	C	D	E
LOUNGE CHAIR WITH SLED BASE					
BSH02	£570	£621	£673	£725	£777



CODE	RRP
CIRCULAR TABLE	
OTIS01-CT	£375

MTO SOFT SEATING

MTO



4-5 week lead time

MFC FINISHES



White (WH)



Kendal Oak (KO)

CELESTRA

LOUNGE CHAIR & SOFA

Celestra is a clean, attractive soft seating solution that can add to the welcoming atmosphere of any reception area, allowing visitors to feel at ease while they wait. The simple, classic design of the conveniently sized one and two seater tub chairs are fully upholstered and available in different colour and fabric options to match any existing office colour scheme.



Product warranty



Designed & manufactured

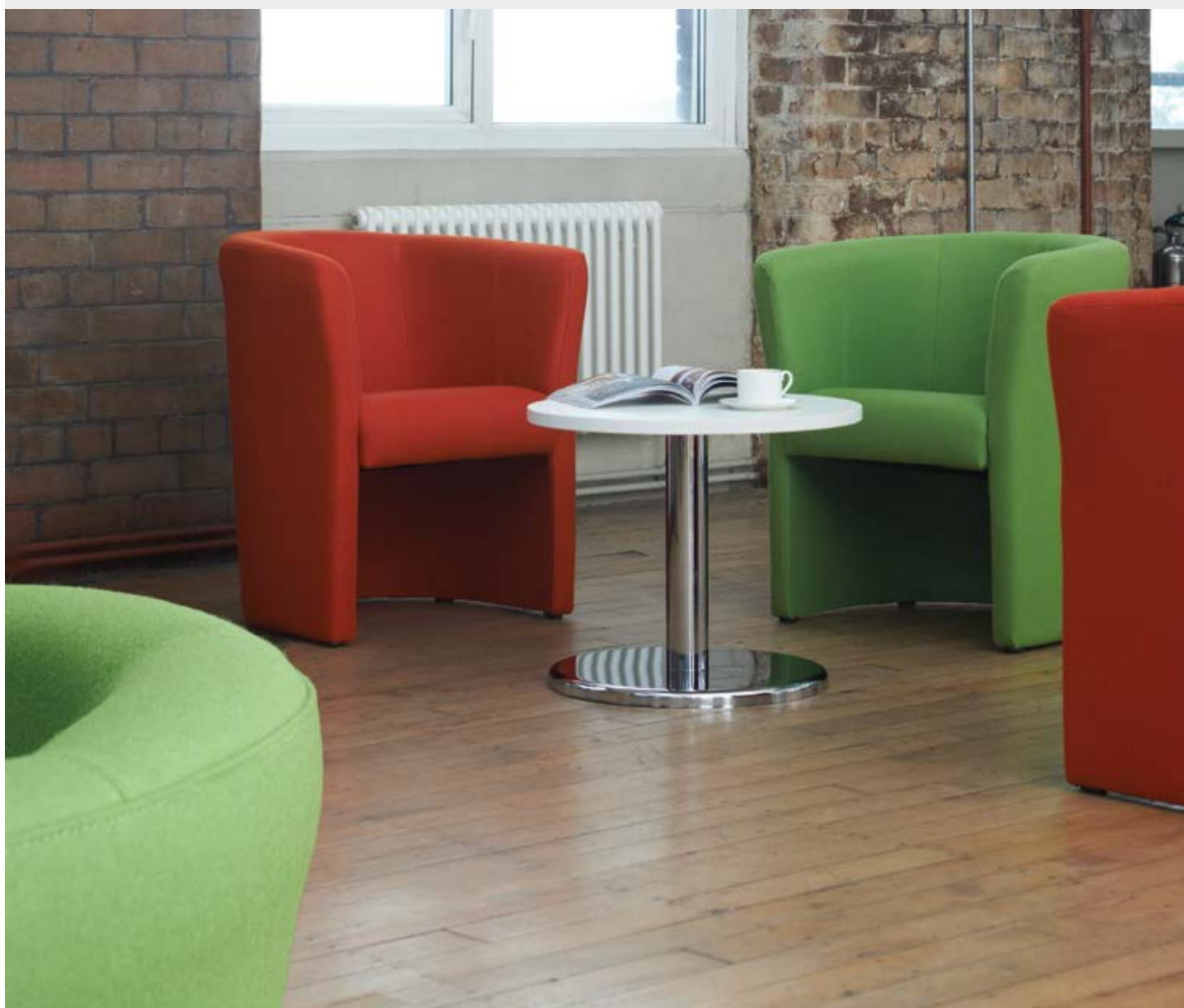

Specification

	Overall width	Overall depth	Overall height	Seat width	Seat depth	Seat height	Back width	Back height
CEL50001	700	650	850	470	500	470	450	410
CEL50002	1300	650	850	970	500	470	950	410

Celestra | Tub Chair & Sofa

Multi-use compact design available in 1 and 2 seaters

Multitude of fabric and colour options available

Curved, contoured backs for enhanced comfort

Matching feet options to glide across the floor



CODE	Fabric bands				
	A	B	C	D	E
SINGLE SEATER SOFA					
CEL50001	£530	£575	£625	£675	£780



CODE	Fabric bands				
	A	B	C	D	E
TWO SEATER SOFA					
CEL50002	£840	£890	£950	£1050	£1175

MTO SOFT SEATING

MTO



4-5 week lead time

GROOVE

UPHOLSTERED STOOLS

Groove breakout seating provides a flexible and informal seating solution for a wide range of environments. Available in a multitude of shapes, sizes and finishes, and with endless permutations, Groove stools can be scattered individually or used as interlinking seating to add colour, fun and inspiration to breakout areas and offices.



Specification

	Overall width	Overall depth	Overall height
GR01	410	410	430
GR02	410	410	430
GR03	910	410	430
BOP04	500	500	435

Groove | Upholstered Stools

Use on their own or mix with other seating ranges

Easy to move and re-configure to suit different environments

Deep-foamed seats offering enhanced comfort within relaxation areas

Stylish accessory for any breakout or reception area



Fabric bands					
CODE	A	B	C	D	E
BUBBLE					
GR01	£228	£249	£270	£290	£311



Fabric bands					
CODE	A	B	C	D	E
SHADE					
BOP04	£311	£332	£352	£373	£394



Fabric bands					
CODE	A	B	C	D	E
SQUARE					
GR02	£228	£249	£270	£290	£311

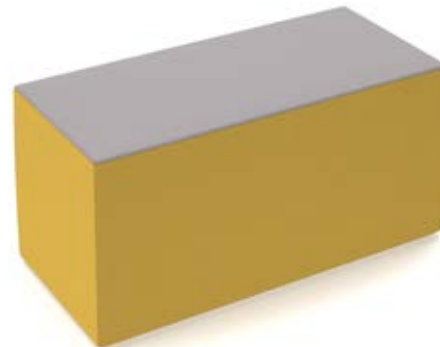

Fabric bands					
CODE	A	B	C	D	E
BRICK					
GR03	£337	£358	£378	£399	£420

MTO SOFT SEATING

MTO



4-5 week lead time

OSLO

SOFAS

The Oslo fully upholstered sofa can easily adapt to all spaces due to its aesthetic simplicity, angular corners and generous proportions. Often situated in reception areas, Oslo is equally at home in informal meeting spaces, private offices and breakout spaces, offering employees and visitors alike a comfortable seating experience, without compromising on style.



Product warranty



Designed & manufactured



Specification

	Overall width	Overall depth	Overall height	Seat width	Seat depth	Seat height	Back width	Back height
OSL50001	800	710	850	555	525	455	555	395
OSL50002	1340	710	850	1105	525	455	1105	395
OSL50003	1880	710	850	1640	525	455	1640	395

Oslo | Sofas

Made to order fabric reception seating ideal for any modern interior

1, 2 and 3 seater sofas available in a multitude of fabric options

Ideal for where people can go for some time away from their desk

Features deep cushioned seats and backs with a square block design



Fabric bands					
CODE	A	B	C	D	E
SINGLE SEATER SOFA					
OSL50001	£1000	£1050	£1150	£1250	£1450



Fabric bands					
CODE	A	B	C	D	E
TWO SEATER SOFA					
OSL50002	£1300	£1400	£1500	£1600	£1800



Fabric bands					
CODE	A	B	C	D	E
THREE SEATER SOFA					
OSL50003	£1500	£1600	£1700	£1800	£2000



Optional Accessories

POWER MODULE MOUNTED ON SEAT FRONT

PX-1-K	PIXEL BLACK	£330
--------	-------------	------

Mains lead to be ordered separately

MEAVY

CHAIRS & SOFA

Meavy chairs combine the beauty of high quality upholstery and the strength of a solid beech wooden frame for a stylish yet durable seating option. Available with or without arms, the chair's simple, classic design allows it to complement any office environment and keep visitors comfortable and relaxed. Add a wooden frame table to complete the look, suitable for any waiting area.



Product warranty



Designed & manufactured



Specification

	Overall width	Overall depth	Overall height	Seat width	Seat depth	Seat height	Back width	Back height
MEA50001	520	720	850	470	510	470	470	470
MEA50002	1050	720	850	940	510	470	940	470
MEA50004	520	720	850	470	510	470	470	470

Meavy | Chairs & Sofa

Elegant, flowing lines with a solid beech frame

No arm and with arm, 1 and 2 seater combinations

Ideal around a coffee table in a reception or waiting area

Sturdy Birch plywood internal back frame



Fabric bands					
CODE	A	B	C	D	E
SINGLE SEATER CHAIR					
MEA50001	£500	£550	£600	£650	£700



Fabric bands					
CODE	A	B	C	D	E
SINGLE SEATER CHAIR WITH ARMS					
MEA50004	£600	£650	£700	£750	£800



Fabric bands					
CODE	A	B	C	D	E
DOUBLE SEATER CHAIR WITH ARMS					
MEA50002	£750	£800	£850	£900	£1000



Fabric bands					
CODE	A	B	C	D	E
FIBRE FILLED SCATTER CUSHION 350 X 350MM					
SCAT-CUSH-01	£91	£104	£116	£130	£142



Fabric bands					
CODE	A	B	C	D	E
FIBRE FILLED LUMBAR CUSHION 550 X 350MM					
LUMB-CUSH-01	£104	£116	£130	£142	£155

MTO SOFT SEATING

MTO



4-5 week lead time

YEALM

LOUNGE CHAIRS

Yealm is a stylish reception soft seating solution with a curved laminated wooden frame and ergonomic back design that allows visitors to wait in comfort whenever they visit the office. This modular seating solution comes with a solid wood top table and a selection of fabric options, so you can custom design the seats to fit your office perfectly in rows of any number of chairs.



Product warranty



Designed & manufactured



Specification

	Overall width	Overall depth	Overall height	Seat width	Seat depth	Seat height	Back width	Back height
YEA50001	540	570	890	460	460	380	460	510
YEA50004	540	570	890	460	460	380	460	510
YEA50005	540	570	890	460	460	380	460	510
YEA50006	540	570	890	460	460	380	460	510
YEA50008	910	380	380	-	-	-	-	-

Yealm | Lounge Chairs

Elegant, flowing lines with a laminated wooden frame

Low arm, high arm, left hand and right hand seating options

Ideal around the matching coffee table in a reception or waiting area

Laminated bent wood frame with clear hard wearing lacquer



Fabric bands					
CODE	A	B	C	D	E
NO ARMS					
YEA50001	£440	£466	£492	£518	£544



Fabric bands					
CODE	A	B	C	D	E
WITH ARMS					
YEA50004	£440	£466	£492	£518	£544



Fabric bands					
CODE	A	B	C	D	E
LEFT ARM					
YEA50005	£440	£466	£492	£518	£544



Fabric bands					
CODE	A	B	C	D	E
RIGHT ARM					
YEA50006	£440	£466	£492	£518	£544



CODE	RRP
TABLE	
YEA50008	£300

MTO SOFT SEATING

MTO



4-5 week lead time



Beech

ALTO

CONFIGURABLE SEATING

Alto is a modular range of reception furniture that can be customised to fit the specific needs of the modern office, providing comfortable office seating for visitors while they wait. The flexibility of the modular components with curved, straight, left and right hand, corner and upholstered table options allows for multiple configurations without sacrificing on style.



Product warranty



Designed & manufactured



Specification

	Overall width	Overall depth	Overall height	Seat width	Seat depth	Seat height	Back width	Back height
ALT50001	580	640	780	580	490	420	580	360
ALT50002	560	640	780	480	490	420	580	360
ALT50004	770	640	780	490	490	420	580	360
ALT50005	675	640	780	580	490	420	580	360
ALT50006	675	640	780	580	490	420	580	360
ALT50007	675	640	780	580	490	420	580	360
ALT50008	620	620	275					
ALT50009	100	400	200					

Alto | Configurable Seating

Simple, versatile selection of shapes for large and small footprints

Easy to move and re-configure to suit different environments

Deep-foamed seats offering enhanced comfort within relaxation areas

Solid wooden internal construction



CODE	Fabric bands				
	A	B	C	D	E
SINGLE SEATER WITH NO ARMS					
ALT50001	£400	£450	£500	£550	£600



CODE	Fabric bands				
	A	B	C	D	E
SINGLE SEATER CONCAVE					
ALT50002	£400	£450	£500	£550	£600



CODE	Fabric bands				
	A	B	C	D	E
SINGLE SEATER WITH ARMS					
ALT50004	£550	£600	£700	£750	£850



CODE	Fabric bands				
	A	B	C	D	E
SINGLE SEATER WITH LEFT ARM					
ALT50005	£500	£550	£600	£650	£750



CODE	Fabric bands				
	A	B	C	D	E
SINGLE SEATER WITH RIGHT ARM					
ALT50006	£500	£550	£600	£650	£750



CODE	Fabric bands				
	A	B	C	D	E
SINGLE SEATER CORNER SECTION					
ALT50007	£700	£750	£800	£850	£950



CODE	Fabric bands				
	A	B	C	D	E
TABLE					
ALT50008	£200	£225	£250	£275	£300



CODE	Fabric bands				
	A	B	C	D	E
TABLE WITH ION POWER MODULE					
ALT50008-P	£325	£350	£375	£400	£425

Mains lead sold separately



CODE	Fabric bands				
	A	B	C	D	E
ARM CUSHION					
ALT50009	£175	£200	£225	£250	£300

MTO SOFT SEATING

MTO



4-5 week lead time

LYRIC

SOFAS

Lyric is a modern and stylish upholstered sofa collection designed to provide employees with an area to unwind together and build good working relationships, or for visitors to rest in comfort. The clean lines and functionality make Lyric an ideal choice for breakout spaces and reception areas, where the extensive range of fabrics and finishes can create a relaxed and unique environment.



Specification

	Overall width	Overall depth	Overall height	Seat width	Seat depth	Seat height	Back width	Back height
LYR50001	900	820	790	600	510	420	600	410
LYR50002	1450	820	790	1160	510	420	1160	410
LYR50003	2010	820	790	1720	510	420	1720	410

Lyric Sofa | Sofas

Available in 1, 2 and 3 seater combinations with two-tone fabric options

Choice of distinctive polished chrome or solid oak tapered legs

Classic style with clean lines, great comfort and broad appeal

Ideal in a reception or waiting area around a coffee table



CODE	Fabric bands				
	A	B	C	D	E
SINGLE SEATER SOFA - METAL LEGS					
LYR50001-ML	£1200	£1300	£1400	£1500	£1700
SINGLE SEATER SOFA - WOODEN FEET					
LYR50001-WF	£1350	£1450	£1550	£1650	£1850

CODE	Fabric bands				
	A	B	C	D	E
TWO SEATER SOFA - METAL LEGS					
LYR50002-ML	£1600	£1700	£1800	£1900	£2100
TWO SEATER SOFA - WOODEN FEET					
LYR50002-WF	£1750	£1850	£1950	£2050	£2250



CODE	Fabric bands				
	A	B	C	D	E
THREE SEATER SOFA - METAL LEGS					
LYR50003-ML	£1900	£2000	£2100	£2200	£2400
THREE SEATER SOFA - WOODEN FEET					
LYR50003-WF	£2050	£2150	£2250	£2350	£2550



Optional Accessories

POWER MODULE MOUNTED UNDER SEAT

PH-1-K PHASE BLACK **£414**

Mains lead to be ordered separately

MTO



4-5 week lead time

LYRIC MODULAR

CONFIGURABLE SEATING

5 Product warranty

 Designed & manufactured

Lyric Modular allows you to add and remove individual elements of the soft seating with ease to create a bespoke piece of furniture that can easily be re-sized to suit any office space, large or small. The Lyric Modular upholstered sofa is ideal for providing employees with an area to relax, whilst maintaining a business feel and providing a level of comfort that lends itself to informal get togethers.



Specification

	Overall width	Overall depth	Overall height	Seat width	Seat depth	Seat height	Back width	Back height
LYRNA	565	820	790	565	510	420	565	410
LYRC	820	820	790	510	510	420	510	410
LYRRA	740	820	790	580	510	420	580	410
LYRLA	740	820	790	580	510	420	580	410

Lyric Modular | Configurable Seating

Easy to re-configure to suit all work spaces with two-tone fabric options

Multi-functional soft seating system for maximum flexibility

Ideal for informal meetings or large landscapes for public spaces

Made up of 4 large seating options to assemble in multiple configurations



Fabric bands					
CODE	A	B	C	D	E
CHAIR WITH NO ARMS AND METAL LEGS					
LYRNA-ML	£650	£700	£750	£800	£850
CHAIR WITH NO ARMS AND WOODEN FEET					
LYRNA-WF	£750	£800	£850	£900	£950



Fabric bands					
CODE	A	B	C	D	E
CORNER UNIT WITH METAL LEGS					
LYRC-ML	£1000	£1050	£1100	£1150	£1250
CORNER UNIT WITH WOODEN FEET					
LYRC-WF	£1100	£1150	£1200	£1250	£1350



Fabric bands					
CODE	A	B	C	D	E
CHAIR WITH RIGHT ARM AND METAL LEGS					
LYRRA-ML	£850	£900	£950	£1000	£1050
CHAIR WITH RIGHT ARM AND WOODEN FEET					
LYRRA-WF	£950	£1000	£1050	£1100	£1150



Fabric bands					
CODE	A	B	C	D	E
CHAIR WITH LEFT ARM AND METAL LEGS					
LYRLA-ML	£850	£900	£950	£1000	£1100
CHAIR WITH LEFT ARM AND WOODEN FEET					
LYRLA-WF	£950	£1000	£1050	£1100	£1200

ALBAN

LOW & HIGH BACK SOFAS

Add style, colour and interest to any office space with the Alban soft seating range, designed to provide the perfect solution to small and large breakout and reception areas. With so many seating designs and fabrics available, Alban will bring a touch of modernism to any office and keep both employees and customers content by offering them a relaxing zone they can appreciate away from their desks.



Specification

	Overall width	Overall depth	Overall height	Seat width	Seat depth	Seat height	Back width	Back height
ALBAN01-LOW	985	800	730	530	560	430	530	300
ALBAN02-LOW	1700	800	730	1245	560	430	1245	300
ALBAN03-LOW	2050	800	730	1595	560	430	1595	300
ALBAN01-HIGH	985	800	1250	530	560	430	530	690
ALBAN02-HIGH	1700	800	1250	1245	560	430	1245	690
ALBAN03-HIGH	2050	800	1250	1595	560	430	1595	690
ALBAN01-C	985	800	1800	530	560	430	530	1320
ALBFT	620	500	430					

Alban | Low & High Back Sofas

A comfortable place to sit for prolonged periods to break up the day

Available in 1, 2 and 3 seater combinations with two-tone fabric options

Create a space that can accommodate groups in privacy, comfort and style

Polished chrome legs with floor protectors to move without scratching the floor



Fabric bands					
CODE	A	B	C	D	E
SINGLE SEATER LOW BACK SOFA					
ALBAN01-LOW	1100	1200	1300	1400	1600



Fabric bands					
CODE	A	B	C	D	E
TWO SEATER LOW BACK SOFA					
ALBAN02-LOW	1600	1700	1800	2000	2200



Fabric bands					
CODE	A	B	C	D	E
THREE SEATER LOW BACK SOFA					
ALBAN03-LOW	1900	2000	2100	2300	2500



Fabric bands					
CODE	A	B	C	D	E
SINGLE SEATER HIGH BACK SOFA					
ALBAN01-HIGH	1900	2000	2100	2300	2500



Fabric bands					
CODE	A	B	C	D	E
TWO SEATER HIGH BACK SOFA					
ALBAN02-HIGH	2250	2350	2450	2550	2750



Fabric bands					
CODE	A	B	C	D	E
THREE SEATER HIGH BACK SOFA					
ALBAN03-HIGH	2500	2600	2700	2900	3100



Fabric bands					
CODE	A	B	C	D	E
FOOT STOOL					
ALBFT	800	850	900	950	1000



Optional Accessories

POWER MODULE MOUNTED UNDER SEAT

PH-1-K PHASE BLACK **£414**

Mains lead to be ordered separately

MTO SOFT SEATING

MTO



4-5 week lead time

NERA

CONFIGURABLE SEATING

Nera is one of the most versatile soft seating ranges available, offering a completely flexible solution for any breakout area. The simple, smart components of the Nera range can be used individually or arranged in a variety of dynamic configurations, making it the ideal collection for informal meetings, and all working environments now and in the future.



Product warranty



Designed & manufactured



Specification

	Overall width	Overall depth	Overall height	Seat width	Seat depth	Seat height	Back width	Back height
NERA-D	1400	700	430	1400	510	430		
NERA-D-LB	1400	700	790	1400	510	430	700	440
NERA-D-RB	1400	700	790	1400	510	430	700	440
NERA-D-BB	1400	700	790	1400	510	430	1400	440
NERA-D-BLA	1400	700	790	1210	510	430	650	440
NERA-D-BRA	1400	700	790	1210	510	430	650	440
NERA-D-BBLA	1400	700	790	1210	510	430	1350	440
NERA-D-BBRA	1400	700	790	1210	510	430	1350	440
NERA-D-BRABLA	1400	700	790	1020	510	430	1300	440

Nera | Configurable Seating

Versatile and easy to re-configure with frames available in black

Single & double soft seating benches to assemble in multiple configurations

Extra deep high density foam seats for durability and comfort

Suitable for any breakout space with matching coffee tables and power unit



Fabric bands					
CODE	A	B	C	D	E
DOUBLE BENCH WITH NO BACK					
NERA-D-K	£850	£900	£950	£1000	£1100



Fabric bands					
CODE	A	B	C	D	E
DOUBLE BENCH WITH LEFT HAND BACK					
NERA-D-LB-K	£950	£1000	£1050	£1100	£1200



Fabric bands					
CODE	A	B	C	D	E
DOUBLE BENCH WITH RIGHT HAND BACK					
NERA-D-RB-K	£950	£1000	£1050	£1100	£1200



Fabric bands					
CODE	A	B	C	D	E
DOUBLE BENCH WITH BACK					
NERA-D-BB-K	£1000	£1100	£1200	£1300	£1400



Fabric bands					
CODE	A	B	C	D	E
DOUBLE BENCH WITH LEFT HAND ARM AND BACK					
NERA-D-BLA-K	£1250	£1350	£1450	£1550	£1650



Fabric bands					
CODE	A	B	C	D	E
DOUBLE BENCH WITH RIGHT HAND ARM AND BACK					
NERA-D-BRA-K	£1000	£1100	£1200	£1300	£1400



Fabric bands					
CODE	A	B	C	D	E
DOUBLE BENCH WITH LEFT HAND ARM AND FULL BACK					
NERA-D-BBLA-K	£1250	£1350	£1450	£1550	£1650



Fabric bands					
CODE	A	B	C	D	E
DOUBLE BENCH WITH RIGHT HAND ARM AND FULL BACK					
NERA-D-BBRA-K	£1250	£1350	£1450	£1550	£1650



Fabric bands					
CODE	A	B	C	D	E
DOUBLE BENCH WITH ARMS AND FULL BACK					
NERA-D-BRABLA-K	£1550	£1650	£1750	£1850	£1950

MTO SOFT SEATING



Black frame
-K



4-5 week
lead time



Fabric bands					
CODE	A	B	C	D	E
SINGLE BENCH					
NERA-S-K	£700	£750	£800	£850	£900

Fabric bands					
CODE	A	B	C	D	E
CORNER UNIT					
NERA-Q-K	£600	£630	£660	£690	£750

Fabric bands					
CODE	A	B	C	D	E
POWER UNIT					
NERA-PU-K	£900	£950	£1000	£1050	£1100



Fabric bands					
CODE	A	B	C	D	E
SINGLE BENCH WITH BACK					
NERA-S-B-K	£800	£850	£900	£950	£1050

Fabric bands					
CODE	A	B	C	D	E
SINGLE BENCH WITH LEFT ARM AND BACK					
NERA-S-BLA-K	£850	£950	£1050	£1150	£1250

Fabric bands					
CODE	A	B	C	D	E
SINGLE BENCH WITH RIGHT ARM AND BACK					
NERA-S-BRA-K	£850	£950	£1050	£1150	£1250



CODE	MTO
SQUARE TABLE	
NERA-S-TABLE-K	£361

CODE	MTO
CORNER TABLE	
NERA-Q-TABLE-K	£361

DIMENSIONS

	Overall width	Overall depth	Overall height	Seat width	Seat depth	Seat height
NERA-S-B-K	700	700	430	700	510	430
NERA-S-BLA-K	700	700	790	600	510	430
NERA-S-BRA-K	700	700	790	600	510	430
NERA-S-K	700	700	790	700	510	430
NERA-Q-K	700	700	430	700	700	430
NERA-PU-K	700	250	430			
NERA-S-TABLE-K	700	700	240			
NERA-Q-TABLE-K	700	700	240			

MTO

MFC FINISHES



Black frame
-K



4-5 week
lead time



Black
(K)



White
(WH)



Kendal Oak
(KO)

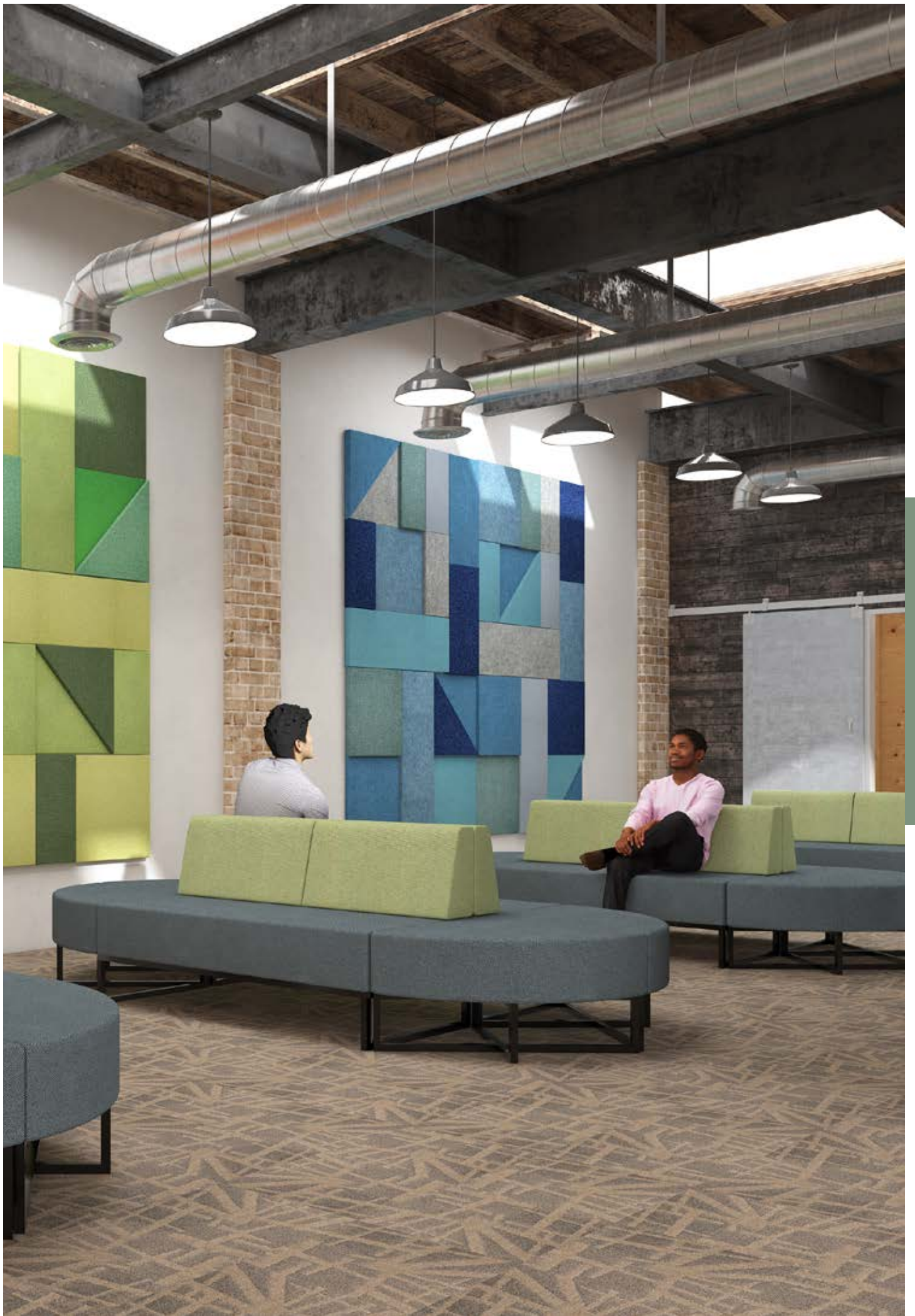

ENCORE²

LOW & HIGH BACK SOFAS

Encore² is a distinctively elegant soft seating solution that is high in quality and unique in design. The clean, modern lines of the seating, available in a choice of high and low backs, with built-in lumbar support and angular arms give Encore² a contemporary look that will suit many open plan offices, creating a work space which will inspire employees collaborations to a new level of function and sophistication.



Product warranty



Designed & manufactured



Specification

	Overall width	Overall depth	Overall height	Seat width	Seat depth	Seat height	Back width	Back height
ENC01L	790	730	920	600	490	450	590	500
ENC02L	1390	730	920	1200	490	450	1190	500
ENC03L	1990	730	920	1800	490	450	1790	500
ENC01H	790	730	1270	600	490	450	590	850
ENC02H	1390	730	1270	1200	490	450	1190	850
ENC03H	1990	730	1270	1800	490	450	1790	850
ENC-TAB01	600	600	310					
ENC-TAB02	1000	600	310					

Encore² Sofas | Low & High Back Sofas

Classic style with clean lines, great comfort and broad appeal



Fabric bands

CODE	A	B	C	D	E
SINGLE SEATER LOW BACK SOFA - METAL FRAME					
ENC01L-MF	1500	1600	1700	1800	1900
SINGLE SEATER LOW BACK SOFA - WOODEN FRAME					
ENC01L-WF	1800	1900	2000	2100	2200

Choice of distinctive black steel or wooden sled frames



Fabric bands

CODE	A	B	C	D	E
TWO SEATER LOW BACK SOFA - METAL FRAME					
ENC02L-MF	1800	1900	2000	2100	2200
TWO SEATER LOW BACK SOFA - WOODEN FRAME					
ENC02L-WF	2100	2200	2300	2400	2500

Deep-foamed seat construction with two-tone fabric options



Fabric bands

CODE	A	B	C	D	E
THREE SEATER LOW BACK SOFA - METAL FRAME					
ENC03L-MF	2100	2200	2300	2500	2700
THREE SEATER LOW BACK SOFA - WOODEN FRAME					
ENC03L-WF	2400	2500	2600	2800	3000

Available with integrated power supply built in to the frame



Fabric bands

CODE	A	B	C	D	E
SINGLE SEATER HIGH BACK SOFA - METAL FRAME					
ENC01H-MF	1700	1800	1900	2100	2300
SINGLE SEATER HIGH BACK SOFA - WOODEN FRAME					
ENC01H-WF	2000	2100	2200	2400	2600



Fabric bands

CODE	A	B	C	D	E
TWO SEATER HIGH BACK SOFA - METAL FRAME					
ENC02H-MF	2000	2100	2200	2300	2500
TWO SEATER HIGH BACK SOFA - WOODEN FRAME					
ENC02H-WF	2300	2400	2500	2600	2800



Fabric bands

CODE	A	B	C	D	E
THREE SEATER HIGH BACK SOFA - METAL FRAME					
ENC03H-MF	2300	2400	2500	2700	2900
THREE SEATER HIGH BACK SOFA - WOODEN FRAME					
ENC03H-WF	2600	2700	2800	3000	3200



CODE	MTO
SQUARE COFFEE TABLE - METAL FRAME	
ENC-TAB01-MF	£186



CODE	MTO
RECTANGULAR COFFEE TABLE - METAL FRAME	
ENC-TAB02-MF	£213



Optional Accessories

POWER MODULE MOUNTED UNDER SEAT		
PH-1-K	PHASE BLACK	£414
Mains lead to be ordered separately		

MTO



4-5 week lead time

MFC FINISHES



White (WH)



Kendal Oak (KO)

ENCORE² MODULAR

CONFIGURABLE SEATING

5 Product warranty

 Designed & manufactured

The Encore2 Modular is as reconfigurable as it is versatile and can be grouped together to create large landscape configurations which are ideal for meetings and reception areas, or to be used as stand-alone pieces. The quality construction and high traffic design deliver an endless array of configurations and the high back units offer comfort and privacy where people can work, team up or gather.



Specification

	Overall width	Overall depth	Overall height	Seat width	Seat depth	Seat height	Back width	Back height
ENC-MOD01L	600	730	920	600	490	450	590	500
ENC-MOD01L-CC	780	730	920	650	490	450	650	500
ENC-MOD02L-CV	920	730	920	1000	490	450	650	500
ENC-MOD02L	1200	730	920	1200	490	450	1190	500
ENC-MOD02L-LA	1295	730	920	1200	490	450	1190	500
ENC-MOD02L-RA	1295	730	920	1200	490	450	1190	500
ENC-MOD01L-PM	200	730	920					
ENC-TAB01	600	600	310					
ENC-TAB02	1000	600	310					

Encore² Modular | Configurable Seating

Offering a completely flexible solution for any breakout area

Components can be arranged in a variety of dynamic configurations

Ideal for employees and small groups to relax or meet informally

Easy to re-configure to suit all work spaces with two-tone fabric options



CODE	Fabric bands				
	A	B	C	D	E
LOW BACK SOFA WITH BLACK SLED FRAME					
ENC-MOD01L-MF	£900	£1000	£1100	£1200	£1400
LOW BACK SOFA WITH WOODEN SLED FRAME					
ENC-MOD01L-WF	£1200	£1300	£1400	£1500	£1700

CODE	Fabric bands				
	A	B	C	D	E
CONCAVE LOW BACK SOFA WITH BLACK SLED FRAME					
ENC-MOD01L-CC-MF	£1200	£1300	£1400	£1500	£1600
CONCAVE LOW BACK SOFA WITH WOODEN SLED FRAME					
ENC-MOD01L-CC-WF	£1500	£1600	£1800	£1950	£2050

CODE	Fabric bands				
	A	B	C	D	E
CONVEX LOW BACK SOFA WITH BLACK SLED FRAME					
ENC-MOD02L-CV-MF	£1200	£1300	£1400	£1500	£1700
CONVEX LOW BACK SOFA WITH WOODEN SLED FRAME					
ENC-MOD02L-CV-WF	£1500	£1600	£1700	£1800	£2000



CODE	Fabric bands				
	A	B	C	D	E
LOW BACK SOFA WITH NO ARMS & BLACK SLED FRAME					
ENC-MOD02L-MF	£1300	£1400	£1500	£1600	£1800
LOW BACK SOFA WITH NO ARMS & WOODEN SLED FRAME					
ENC-MOD02L-WF	£1600	£1700	£1800	£1900	£2100

CODE	Fabric bands				
	A	B	C	D	E
LOW BACK SOFA WITH LEFT ARM & BLACK SLED FRAME					
ENC-MOD02L-LA-MF	£1500	£1600	£1700	£1900	£2100
LOW BACK SOFA WITH LEFT ARM & WOODEN SLED FRAME					
ENC-MOD02L-LA-WF	£1800	£1900	£2000	£2200	£2400

CODE	Fabric bands				
	A	B	C	D	E
LOW BACK SOFA WITH RIGHT ARM & BLACK SLED FRAME					
ENC-MOD02L-RA-MF	£1500	£1600	£1700	£1900	£2100
LOW BACK SOFA WITH RIGHT ARM & WOODEN SLED FRAME					
ENC-MOD02L-RA-WF	£1800	£1900	£2000	£2200	£2400



CODE	Fabric bands				
	A	B	C	D	E
POWER MODULE DIVIDER WITH BLACK SLED FRAME					
ENC-MOD01L-PM-MF	£1300	£1400	£1500	£1600	£1800
POWER MODULE DIVIDER WITH WOODEN SLED FRAME					
ENC-MOD01L-PM-WF	£1600	£1700	£1800	£1900	£2100



CODE	MTO
SQUARE COFFEE TABLE - METAL FRAME	
ENC-TAB01-MF	£186



CODE	MTO
RECTANGULAR COFFEE TABLE - METAL FRAME	
ENC-TAB02-MF	£213

MTO



4-5 week lead time

MFC FINISHES



White (WH)



Kendal Oak (KO)

Encore² Modular | Configurable Seating



CODE	Fabric bands				
	A	B	C	D	E
HIGH BACK SOFA WITH BLACK SLED FRAME					
ENC-MOD01H-MF	£1200	£1300	£1400	£1500	£1600
HIGH BACK SOFA WITH WOODEN SLED FRAME					
ENC-MOD01H-WF	£1500	£1600	£1700	£1800	£1900



CODE	Fabric bands				
	A	B	C	D	E
CONCAVE HIGH BACK SOFA WITH BLACK SLED FRAME					
ENC-MOD01H-CC-MF	£1500	£1600	£1800	£1950	£2050
CONCAVE HIGH BACK SOFA WITH WOODEN SLED FRAME					
ENC-MOD01H-CC-WF	£1800	£1900	£2100	£2250	£2350



CODE	Fabric bands				
	A	B	C	D	E
CONVEX HIGH BACK SOFA WITH BLACK SLED FRAME					
ENC-MOD02H-CV-MF	£1500	£1600	£1700	£1900	£2100
CONVEX HIGH BACK SOFA WITH WOODEN SLED FRAME					
ENC-MOD02H-CV-WF	£1800	£1900	£2000	£2200	£2400



CODE	Fabric bands				
	A	B	C	D	E
HIGH BACK SOFA WITH NO ARMS & BLACK SLED FRAME					
ENC-MOD02H-MF	£1600	£1700	£1800	£2000	£2200
HIGH BACK SOFA WITH NO ARMS & WOODEN SLED FRAME					
ENC-MOD02H-WF	£1900	£2000	£2100	£2300	£2500



CODE	Fabric bands				
	A	B	C	D	E
HIGH BACK SOFA WITH LEFT ARM & BLACK SLED FRAME					
ENC-MOD02H-LA-MF	£2000	£2100	£2200	£2400	£2600
HIGH BACK SOFA WITH LEFT ARM & WOODEN SLED FRAME					
ENC-MOD02H-LA-WF	£2300	£2400	£2500	£2700	£2900



CODE	Fabric bands				
	A	B	C	D	E
HIGH BACK SOFA WITH RIGHT ARM & BLACK SLED FRAME					
ENC-MOD02H-RA-MF	£2000	£2100	£2200	£2400	£2600
HIGH BACK SOFA WITH RIGHT ARM & WOODEN SLED FRAME					
ENC-MOD02H-RA-WF	£2300	£2400	£2500	£2700	£2900



CODE	Fabric bands				
	A	B	C	D	E
TALL POWER MODULE DIVIDER WITH BLACK SLED FRAME					
ENC-MOD01H-PM-MF	£1500	£1600	£1800	£1950	£2050
TALL POWER MODULE DIVIDER WITH WOODEN SLED FRAME					
ENC-MOD01H-PM-WF	£1800	£1900	£2100	£2250	£2350

DIMENSIONS

	Overall width	Overall depth	Overall height	Seat width	Seat depth	Seat height	Back width	Back height
ENC-MOD01H	600	730	1270	600	490	450	590	850
ENC-MOD01H-CC	780	730	1270	650	490	450	650	850
ENC-MOD02H-CV	920	730	1270	1000	490	450	650	850
ENC-MOD02H	1200	730	1270	1200	490	450	1190	850
ENC-MOD02H-LA	1295	730	1270	1200	490	450	1190	850
ENC-MOD02H-RA	1295	730	1270	1200	490	450	1190	850
ENC-MOD01H-PM	200	730	1270					

MTO



4-5 week lead time



MTO SOFT SEATING

A modern meeting booth is shown in a bright office space. The booth consists of a light-colored sofa, an armchair, and a small table with two coffee cups. The background features large windows overlooking a city building. The entire image is overlaid with a semi-transparent green filter.

MTO MEETING BOOTHS

ENGAGING WORKPLACES



ENCORE² OPEN BOOTH
466



ENCORE² BOOTH
468



ALBAN BOOTH
470

ENCORE² OPEN

MEETING BOOTHS

Encore² Open provides an easy accessible booth with centrally combined worktable. Accompanying Encore's distinctively elegant soft seating range that is high in quality and unique in design. The clean modern lines of the seating create a built-in lumbar support and a contemporary look that will suit many open plan offices. All providing a workspace which will inspire employees collaborations to a new level of function and sophistication.



Specification

	Overall width	Overall depth	Overall height	Seat width	Seat depth	Seat height	Back width	Back height
ENCOP-POD02	2250	695	1270	600	490	450	590	850
ENCOP-POD04	2250	1295	1270	1200	490	450	1190	850
ENCOP-POD06	2250	1895	1270	1800	490	450	1790	850

Table Dimensions

ENCOP-POD02	400-600	600	725
ENCOP-POD04	400-600	1200	725
ENCOP-POD06	400-600	1600	725

Encore² Open | Meeting Booths

Create a quiet space in today's modern collaborative open offices

Visual and acoustic space with effective noise reduction & privacy

Choice of 2, 4 or 6 seater booths with integrated power supply options

Sled frames available in black steel or solid wood with matching table post legs



CODE	Fabric bands				
	A	B	C	D	E
TWO SEATER MEETING BOOTH - METAL FRAME					
ENCOP-POD02-MF	£3500	£3600	£3800	£4000	£4200
TWO SEATER MEETING BOOTH - WOODEN FRAME					
ENCOP-POD02-WF	£4000	£4100	£4300	£4500	£4700

CODE	Fabric bands				
	A	B	C	D	E
FOUR SEATER MEETING BOOTH - METAL FRAME					
ENCOP-POD04-MF	£4000	£4100	£4300	£4500	£4700
FOUR SEATER MEETING BOOTH - WOODEN FRAME					
ENCOP-POD04-WF	£4500	£4600	£4800	£5000	£5200



CODE	Fabric bands				
	A	B	C	D	E
SIX SEATER MEETING BOOTH - METAL FRAME					
ENCOP-POD06-MF	£4700	£4800	£5000	£5300	£5600
SIX SEATER MEETING BOOTH - WOODEN FRAME					
ENCOP-POD06-WF	£5200	£5300	£5500	£5800	£6100



Optional Accessories

TV BRACKET MOUNTED ON INFILL PANEL		
TV-BRACKET	BLACK	£55
POWER MODULE MOUNTED ON INFILL PANEL		
PTN-1T-K	PROTON BLACK	£342

Mains lead to be ordered separately

MTO



4-5 week lead time

MFC FINISHES



Kendal Oak
-KO



White
-WH

ENCORE²

MEETING BOOTHS

Encore² enclosed booths delivers increased privacy and a balanced aesthetic. Expanding upon Encore's distinctively elegant soft seating range that is high in quality and unique in design. The clean modern lines of the seating create a built-in lumbar support and a contemporary look that will suit many open plan offices. With a centrally combined table the booths provides a workspace which will inspire employees collaborations to a new level of function and sophistication.



Specification

	Overall width	Overall depth	Overall height	Seat width	Seat depth	Seat height	Back width	Back height
ENC-POD02	2250	790	1270	600	490	450	590	850
ENC-POD04	2250	1390	1270	1200	490	450	1190	850
ENC-POD06	2250	1990	1270	1800	490	450	1790	850

Table Dimensions

ENC-POD02	400-600	600	725
ENC-POD04	400-600	1200	725
ENC-POD06	400-600	1800	725

Encore² | Meeting Booths

Designed to offer that essential private area in any busy workplace

Enclosed visual and acoustic space to accommodate working groups and teams

Choice of 2, 4 or 6 seater booths with integrated power supply options

Sled frames available in black steel or solid wood with matching table legs



CODE	Fabric bands				
	A	B	C	D	E
TWO SEATER MEETING BOOTH - METAL FRAME					
ENC-POD02-MF	£4000	£4100	£4300	£4500	£4800
TWO SEATER MEETING BOOTH - WOODEN FRAME					
ENC-POD02-WF	£4500	£4600	£4800	£5000	£5300

CODE	Fabric bands				
	A	B	C	D	E
FOUR SEATER MEETING BOOTH - METAL FRAME					
ENC-POD04-MF	£4500	£4600	£4800	£4900	£5200
FOUR SEATER MEETING BOOTH - WOODEN FRAME					
ENC-POD04-WF	£5000	£5100	£5300	£5400	£5700



CODE	Fabric bands				
	A	B	C	D	E
SIX SEATER MEETING BOOTH - METAL LEGS					
ENC-POD06-MF	£5200	£5300	£5500	£5700	£6200
SIX SEATER MEETING BOOTH - WOODEN FRAME					
ENC-POD06-WF	£5700	£5800	£6000	£6200	£6700



Optional Accessories

TV BRACKET MOUNTED ON INFILL PANEL		
TV-BRACKET	BLACK	£55
POWER MODULE MOUNTED ON INFILL PANEL		
PTN-1T-K	PROTON BLACK	£342

Mains lead to be ordered separately

MTO



4-5 week lead time

MFC FINISHES



Kendal Oak
-KO



White
-WH

ALBAN

MEETING BOOTHS

Add style, colour and interest to any office space with the Alban range of booths, designed to provide the perfect solution where collaboration and more focus is required. With a contrasting option along with so many seating designs and fabrics available, Alban will bring a touch of modernism to any office and keep both employees and customers content by offering generous sized seating and large working area.



Product warranty



Designed & manufactured



Specification

	Overall width	Overall depth	Overall height	Seat width	Seat depth	Seat height	Back width	Back height
ALB02	2400	985	1250	530	560	430	530	820
ALB04	2400	1700	1250	1245	560	430	1245	820
ALB06	2400	2050	1250	1595	560	430	1595	820

Table Dimensions

ALB02	400-600	600	725
ALB04	400-600	1200	725
ALB06	400-600	1600	725

Alban | Meeting Booths

Can be used for team meetings, collaborative tasks or as a base for the day

Choice of 2, 4 or 6 seater booths with options for power built into the booth

Ideal for creating a private space in modern open plan office environments

Privacy panel comes complete with a fixed table and a supporting leg



CODE	Fabric bands				
	A	B	C	D	E
TWO PERSON MEDIUM SIZED MEETING BOOTH					
ALB02	£4500	£4600	£4700	£4900	£5100

CODE	Fabric bands				
	A	B	C	D	E
FOUR PERSON MEDIUM SIZED MEETING BOOTH					
ALB04	£5500	£5600	£5700	£5900	£6100



CODE	Fabric bands				
	A	B	C	D	E
SIX PERSON MEDIUM SIZED MEETING BOOTH					
ALB06	£6000	£6100	£6200	£6400	£6800



Optional Accessories

TV BRACKET MOUNTED ON INFILL PANEL		
TV-BRACKET	BLACK	£55
POWER MODULE MOUNTED ON INFILL PANEL		
PTN-1T-K	PROTON BLACK	£342

Mains lead to be ordered separately

MTO



4-5 week lead time

MFC FINISHES



Kendal Oak
-KO



White
-WH



MFC & FABRIC

TEXTURES & TEXTILES

Wood Finishes

We only use FSC-certified wood when manufacturing our products in-house in the UK, with total traceability for every order. Constructed from a chipboard core and finished with a decorative melamine covering, MFC is a versatile product ideal for use with office furniture.

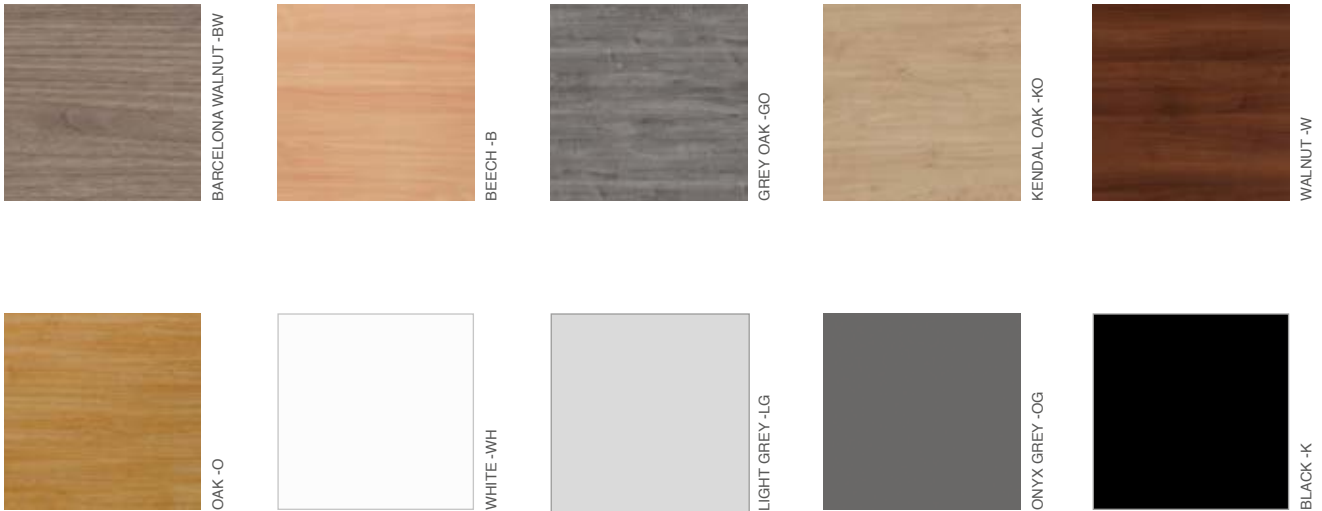

MFC

MFC or Melamine Faced Chipboard is melamine resin impregnated paper bonded both sides on to a chipboard core. MFC can be used to create very modern looking furniture for the home or the office with its printed wood grain on a melamine film that forms the face of the board, with environmentally friendly ABS edging to match the decorative paper top making it very resilient and hardwearing.



MFC & FABRIC

We have committed to stocking a range of 12 best-selling fabrics and 2 vinyls, which will allow us to offer customers an even faster turnaround across the seating range and tailor seating choices to customers' individual specifications.

This colourful selection of fabric colours in the Camira Xtreme, Inloom Bondai and Fresh Vinyl ranges can bring the corporate palette into the office interior, creating a cohesive look or even zone different areas.

Camira Xtreme



YS005 CURACAO



YS084 TAROT

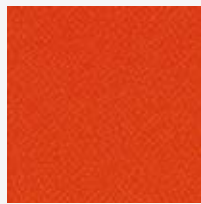

YS168 TORTUGA



YS100 OCEAN



YS094 SLIP



YS081 BLIZZARD



YS102 BRIDGETOWN



YS079 PANAMA



YS026 COSTA



YS159 LOMBOK

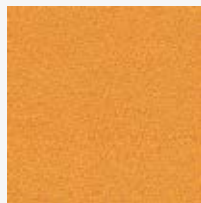

YS072 SOLANO



YS101 DIABLO

Inloom Bondai



8033 BLACK

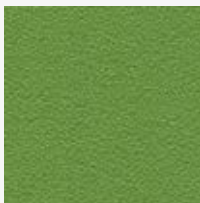

7048 GREEN



6015 BLUE

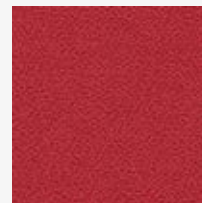

4011 RED

Macflex Sintra Vinyl



74465 OCEAN



10019 BLACK

Agua

RANGE	HAZARD		
	Band	Low	Medium (Crib 5)
Chea	A	✓	✓
Lavoro	A	✓	✓*
Buro	B	✓	✓*
Paint Pot	B	✓	✓
Stol	B	✓	✓
Task	B	✓	✓
Juno	C	✓	✓
Libra	C	✓	✓
Linetta	C	✓	✓
Lunar	C	✓	✓
Hana	C	✓	
Vina	C	✓	
Eden	D	✓	✓
Taurus	D	✓	✓
Tones	D	✓	✓
Sark	D	✓	✓
Nova	D	✓	✓
Fleck	D	✓	✓
Entwine	D	✓	✓
Primeira	D	✓	✓
Alberta Hyde	E	✓	✓
Cord	E	✓	✓
The 7 Collection	E	✓	✓
Dales	E		✓

Camira

RANGE	HAZARD		
	Band	Low	Medium (Crib 5)
Citadel	A	✓	
Era	A	✓	✓*
Phoenix	A	✓	
Target	A	✓	✓
Xtreme	A	✓	✓
Advantage	B	✓	
Gravity	B	✓	
Chateau	C	✓	
Urban	C	✓	✓
Replay	C	✓	✓
Quest	C	✓	✓*
Vita	C	✓	✓
X2	C	✓	✓
Main Line Plus	D	✓	✓
Hi Tech	E	✓	
Penta	E	✓	✓*
Oceanic	E	✓	✓*
Main Line Flax	E	✓	✓
Main Line Twist	E	✓	✓
Sumi	E	✓	✓*
Synergy	E	✓	✓*
24/7 Flax	E	✓	✓
Aquarius	E	✓	
Blazer	E	✓	✓*
Halycon Aspen/Blossom	E	✓	
Hemp	E	✓	✓
Intervene	E	✓	✓
Kyoto	E	✓	✓*
Track	E	✓	✓
Halycon Ceder	E	✓	

Chieftain

RANGE	HAZARD		
	Band	Low	Medium (Crib 5)
Carino	C	✓	✓
Just Colour / Just Patterns	C	✓	✓
Pasha	C	✓	✓
Universal	C	✓	✓
Carousel	D		✓
Casco	D	✓	✓
Lionella	D	✓	✓
Ravel	D		✓
Earthy	E	✓	✓

Gabriel

RANGE	HAZARD		
	Band	Low	Medium (Crib 5)
Tonal	B	✓	
Chili	B	✓	✓
Noma	B	✓	✓
Go Check	C	✓	✓
Step	C	✓	✓
Step Melange	C	✓	✓
Renewed Loop	C	✓	
Connect	D	✓	✓
Cyber	D	✓	
Grain	D	✓	
Focus	D	✓	
Focus Melange	D	✓	
Crisp	E	✓	
Morph	E	✓	✓
Breeze Fusion	E	✓	
Focus Royal	E	✓	

Inloom

RANGE	HAZARD		
	Band	Low	Medium (Crib 5)
Alba	A	✓	✓
Bondai	A	✓	✓
Radio	B	✓	✓
One	C	✓	✓
Time	C	✓	✓
Jet	D	✓	✓
Jeans	D	✓	✓
Jet Bioactive	D	✓	✓
Riva	D	✓	✓
Roccia	D	✓	✓
Respun	D	✓	✓*
Milano	E	✓	✓
Nautilus	E	✓	
Sealife	E	✓	

Panaz

RANGE	HAZARD		
	Band	Low	Medium (Crib 5)
Highland	B		✓
Eco Twist	B	✓	✓
Cadet Colours	C	✓	✓
Alba	C	✓	✓
Aston	C	✓	✓
Eve	C	✓	✓
Nature	C	✓	✓
Linear	D	✓	✓

* With treatment POA

Agua

RANGE	HAZARD		
	Band	Low	Medium (Crib 5)
Lavoro	A	✓	✓*
Buro	B	✓	✓*
Paint Pot	B	✓	✓
Stol	B	✓	✓
Task	B	✓	✓
Juno	C	✓	✓
Libra	C	✓	✓
Linetta	C	✓	✓
Lunar	C	✓	✓
Hana	C	✓	
Vina	C	✓	
Taurus	D	✓	✓
Tones	D	✓	✓
Eden	D	✓	✓
Sark	D	✓	✓
Nova	D	✓	✓
Fleck	D	✓	✓
Entwine	D	✓	✓
Primeira	D	✓	✓
Alberta Hyde	E	✓	✓
Cord	E	✓	✓
Finezza	E	✓	✓
Pearl	E	✓	✓
The 7 Collection	E	✓	✓
Verd Eco	E	✓	✓
Boucle	E	✓	✓
Dales	E		✓

Camira

RANGE	HAZARD		
	Band	Low	Medium (Crib 5)
Era	A	✓	✓*
Quest	C	✓	✓*
Vita	C	✓	✓
X2	C	✓	✓
Aspect	D	✓	
Main Line Plus	D	✓	✓
Oceanic	E	✓	✓*
Halcyon Ceder	E	✓	
Main Line Flax	E	✓	✓
Main Line Twist	E	✓	✓
Sumi	E	✓	✓*
Synergy	E	✓	✓*
24/7 Flax	E	✓	✓
Aquarius	E	✓	
Blazer	E	✓	✓*
Halycon Aspen/Blossom	E	✓	
Hemp	E	✓	✓
Intervene	E	✓	✓
Kyoto	E	✓	✓*
Track	E	✓	✓
Penta	E	✓	✓*

Chieftain

RANGE	HAZARD		
	Band	Low	Medium (Crib 5)
Trimcell	B	✓	
Carino	C	✓	✓
Just Colour	C	✓	✓
Pasha	C	✓	✓
Universal	C	✓	✓
Carousel	D		✓
Casco	D	✓	✓
Lionella	D	✓	✓
Ravel	D		✓
Earthy	E	✓	✓

Gabriel

RANGE	HAZARD		
	Band	Low	Medium (Crib 5)
Chili	B	✓	✓
Noma	B	✓	✓
Go Check	C	✓	✓
Step	C	✓	✓
Step Melange	C	✓	✓
Renewed Loop	C	✓	
Soft Next	C	✓	
Connect	D	✓	✓
Cyber	D	✓	
Grain	D	✓	
Focus	D	✓	
Focus Melange	D	✓	
Crisp	E	✓	
Morph	E	✓	✓
Breeze Fusion	E	✓	
Focus Royal	E	✓	

Inloom

RANGE	HAZARD		
	Band	Low	Medium (Crib 5)
Alba	A	✓	✓
Radio	B	✓	✓
One	C	✓	✓
Time	C	✓	✓
Jet	D	✓	✓
Jeans	D	✓	✓
Jet Bioactive	D	✓	✓
Riva	D	✓	✓
Roccia	D	✓	✓
Respun	D	✓	✓*
Milano	E	✓	
Nautilus	E	✓	
Sealife	E	✓	
Spazio	E	✓	

Panaz

RANGE	HAZARD		
	Band	Low	Medium (Crib 5)
Highland	B		✓**
Eco Twist	B	✓	✓
Cadet Colours	C	✓	✓
Alba	C	✓	✓
Aston	C	✓	✓
Eve	C	✓	✓
Nature	C	✓	✓
Linear	D	✓	✓

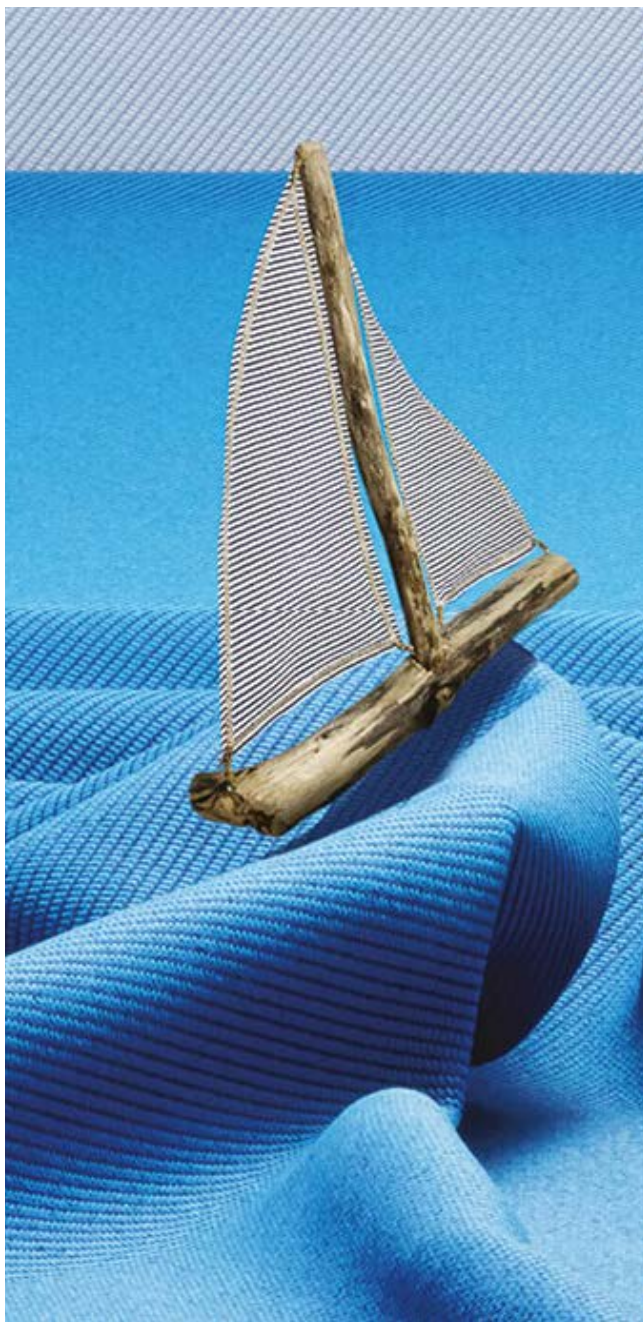

Sustainable fabrics

Sustainability is a key priority for us and we are committed to working closely with suppliers who share the same commitment, offering fabric ranges which allow for sustainable choices to be made and can be recycled at the end of life. Our selection processes factor in environmental concerns, quality standards and social responsibility.

Our fabric offering includes ranges made with recycled PET bottles, including bottles from sea waste. The bottles are sent to a recycling factory, where they are shredded into flakes, processed into chips and then extruded into filaments. This is then turned into yarn ready for weaving.

- **Oceanic** from **Camira** is part of the SEAQUAL Initiative, designed to combat marine plastic pollution and achieve a waste free environment. Oceanic is woven from yarn containing sea waste and each metre contains the equivalent of 26 plastic bottles, playing an important part in reducing the waste that reaches both our landfills and our oceans.

- **Sealife** from **Inloom** is a cross-functional yarn created entirely from post-consumer recycled plastics, woven from a blend of 50% SEQUAL yarn created from plastics collected from the oceans and beaches, and 50% recycled polyester yarn created from recycled PET bottles from land waste. For every 50M roll of Sealife produced, 12kg of marine litter is removed from our oceans.

- **Earthly** from **Chieftain** - is a luxurious fabric is made from 100% recycled fibres and is cradle to cradle certified. It is manufactured entirely from waste textiles. Textiles which may otherwise have gone to landfill. All the recycled yarns (100% recycled cotton and polyester) used in its creation are certified to the Global Recycled Standard. The GRS is internationally recognised, widely understood, trusted, and respected by consumers. It verifies the recycled content of products in every step of the value chain through third-party certification.

- **VerdEco** from **Agua** – is their first sustainable fabric. It's crafted entirely from preconsumer textile waste otherwise destined for landfill, which is then recycled into granules, spun into yarn, and finally re-woven; this is all done using zero water (in fact, upholstering a three-seat sofa in VerdEco saves on average 250 litres of the stuff).

- **Renewed** loop from **Gabriel** – is designed to eliminate waste. The waste age calls for pioneering solutions and innovative design that address the challenges of textile waste. As we all enter a new era of recycling, it is time to leave the throwaway culture behind, embrace waste as a valuable resource, and develop new ways to recycle materials again and again.

The quest to reduce textile waste and save resources, Gabriel have found a way to close the loop and transform textile waste into new textile products. Loop is a revolutionary take-back system, and a new category of products based on recycled textile waste – also called textile-to-textile recycling.

By recycling waste into new textiles that can be recycled again and again, creating a circular system – a closed textile loop – that reduces waste generation, conserves natural resources, and contributes to lowering CO2 emissions.



Fabric care

There are a wide choice of fabrics available and it is important that you select the right fabric for the application as well as creating the perfect finish to the chairs.

We recommend the basic principles for fabric care and maintenance continue to apply:

- Vacuum upholstery regularly to remove dust, dirt and crumbs
- Attend to stains quickly with a damp cloth
- Use branded upholstery shampoo for specific stains
- Periodically use specialist cleaning services eg dry cleaning

Most fabrics are bleach cleanable with a 10% bleach chlorine solution (which will kill Coronavirus germs). There are also an increasing number of fabrics that are anti-microbial to protect against a wide range of bacteria which cause infection - such as MRSA, Salmonella and E.coli - which can cause serious additional ill health that must be avoided by anyone already battling a potentially lethal virus infection.

These fabrics can provide hygiene benefits in wide ranging commercial end-use areas, including healthcare, hospitality, education and contract office.

For further details contact our sales team or refer to the fabric manufacturer websites.



Fabric restrictions

Certain soft seating fabrics listed in this guide may not be suitable for use on all soft seating products. We reserve the right to reject orders to make products in selected fabrics if we believe that the fabric is inappropriate for use due to 'fit and form' unsuitability. In this instance we will always recommend a similar fabric that is more suitable for use on that particular product.

Fabric hazard ratings

Low - EN1021 Parts 1 & 2 cigarette and match
Medium - BS5852 Ignition source 5 / Crib 5

Fabric bands

Please contact our sales team for a price if your preferred fabric choice is not listed. Please make sure you check the suitability of a fabric before recommending a product. If two fabrics are used on one item e.g. two-tone, the cost is calculated on higher of the two fabric bands. All orders for leather are priced on application.

Fabric colour variations

Whilst every effort is made, no guarantees are made against the minor variations in the colour of commercial fabrics. All striped fabric will be upholstered vertically unless advised.

Photographed upholstery

While every effort is made to represent colours accurately, we cannot guarantee the colours you see exactly match the colours of the actual fabric due to printing processes.

Measurements

All measurements are in millimeters and can have a tolerance of ± 12 mm on all soft seating. Measurements may vary depending on components used and we reserve the right to change them from time to time.

Customers own fabrics

Fabrics not listed or customer supplied fabrics need to be approved before acceptance of orders. A pattern charge may apply to some fabrics. We reserve the right to reject fabric that we believe to be unsuitable for the product. We are unable to guarantee any product or fabric supplied by a customer meets fire regulations or standards.

Please contact our sales team if you would like any fabric samples sent out to you.

Ordering

For all made-to-order products, it is our policy that once these products have been ordered they cannot be canceled or amended.

Pricing

All prices shown are in sterling (£) and are subject to current rate of VAT.

Warranty

All products are guaranteed against manufacturing defects, except for upholstery, castors and mechanisms which are subject to usage related wear and tear. The warranty is effective from the day the product leaves the factory and the supplier reserves the right not to apply the warranty in cases of inappropriate use or when a product has been tampered with by a third party or interventions by non-authorized personnel. All complaints concerning the goods must be made in writing and the company shall undertake to repair any product or part of a product that proves to be faulty.

Index

208-218	164	CH8301	344	ETN10-D	221	LYR50001-3	448
2PS	123	CHO300T1	300	ETN18-24	221	LYRC	450
2RAIL	123	CL3M-B	196	ETN18-24-CO	221	LYRLA	450
2RSF	123	CLK121-126	155	EVA300T1	301	LYRNA	450
508-518	164	CLK181-186	155	EV-CHAIN	27	LYRRA	450
79-1	193	COD100-101H	339, 418	EV-LCC-854-1254	27	MAR50004	323
808-816	164	COR01	350	EVM-1200-1600	30	MB1012-1612B	55
A	162	COUEDCR	50	EVSC-1200-1600	25	MB12-16WL/R	54
AC00-01	395	CP12-18S2-3	90	EV-SN	26	MB14-16WB	55
ADH10-12	395	CP14-18EL/R	91	EVSS-1200-1600	25	MB14-18EB	54
AFSBK	166	CP16-18EL2-3	91	EVT-1200-1600	24	MB14-18EL/R	55
AG1000-1800	163	CP16-18ER2-3	91	EVTB-1200-1600	25	MB608-616	54
AGSBK	166	CP16-18S22-23	91	EVT-BCU	27	MB816-1816B	55
AH10-12	294, 395	CP16-18S33	90	EVT-BPK	27	MB8-18	54
AH20-22	294, 395	CP8-18S	90	EVTBT18-20	211	MC12-18P2-3	73
ALB01-03	453	CR610-614-P	104	EVTBT18-20-AB	211	MC14-16WL/R	74
ALB02-06	471	CRM-1-2-3	191	EVTBT24-R	211	MC14-16WLP2-3	74
ALBFT	453	CSI-C	106	EVTR-1400-1600	211	MC14-16WRP2-3	74
ALP01	348	CSI-CS	106	EVT-RET	24	MC14-18EL/R	75
ALT50001-9	446	CSI-D	106	EV-UCC	26	MC16-18ELP2-3	75
ANS-CBL/H	97	CSI-S	106	FL-12-15S	130	MC16-18ERP2-3	75
ANS-CRD	96	CUR300T1	290	FL-22-25D	130	MC16-18P22-23	72
ANS-DED/DRD	97	CWL300K2	309	FL-BKT-LNK	130	MC16-18P33	73
ANS-ED/RD	96	DAR50001-4	420	FL-BLD1	133	MC608-616	72
ANS-MBK	98	DCF2-4	147	FL-CB1-2	132	MC612-616P2	72
ANS-PED	96	DCL15M-B	196	FL-CS1	132	MC616P22	72
ANS-TBC12	99, 225	DD8-20	121	FL-IS1-2	132	MC8-18	73
ANS-TBR22	99, 225	DEC-01	352	FL-MM3	133	MCC800	243
ANS-TBS12	99, 225	DEF2-4	148	FLO300T1	318	MCC800-CO	245
APD2PINF	195	DER100C1	331	FLP12-16	231	MCM12-18P2-3	67
ARBK	166	DER300T1	322	FL-PL1-2	132	MCM14-16WL/R	68
ARC300T1	292	DFLP12-16	229	FL-PLP1-2	132	MCM14-16WLP2-3	68
ASBK	166	DFLPS	229	FLPS	231	MCM14-16WRP2-3	68
ASC300T1	327	DFY300T1	299	FLS09	136	MCM14-18EL/R	69
ATL300T1	319	DG16-20	125	FLS13	136	MCM16-18ELP2-3	69
AUR300T1	302	DH-AF-62366	107	FLS17	137	MCM16-18ERP2-3	69
AVA01-K	338	DHBC	115	FL-SC1	133	MCM16-18P22-23	67
AXERGO	394	DHCC	115	FLS-FCH	139	MCM16-18P33	67
B	145	DH-GZWB	107	FL-SM3	133	MCM608-616	66
B5-15MD	145	DH-HP4SK	107	FLS-SP	139	MCM612-616P2	66
BARI100C1	332	DH-SF-65656	107	FLS-TP	139	MCM616P22	66
BARI200-300T1	323, 326	DIO300T1-K	293	FLS-WR	139	MCM8-18	67
BAS01-02	187	DO16-20	125	FLT800-1800	239	MCR1200-1800	243
BC8-20	124	DRL1000-1200C	223	FL-TS1-3	132	MCS800	243
BCAD-PD	144	DRL1600S	237	FRA400K2	318	MDC800	243
BCC800	247	DRL2400	223	FZ1216-1616	43	MDC800-CO	245
BCR1200-1800	247	DRL900-1800	237	FZ1216-1616-AB	43	MDR1200-1800	243
BCS800	247	DSC40-78	152	FZ128-168	42	MDS800	243
BCSLF	152	DST40-78	150	FZ2416-3216	43	MEA50001-04	442
BD8-20	124	DSTS	151	FZ3616-4816	43	MEL50001-2	356
BDC800	247	DVB01-3	270	FZBT1616/CO	215	MH12-18P2-3	85
BDR1200-1800	247	DVB04-6	271	FZBT3216/CO	215	MH16-18P22-23	85
BDS800	247	E	35	FZCR	44	MH16-18P33	85
BEN50001-03	357	E1212-1612	35	GAS01	187	MH608-616	84
BILB1	313	E1212-1612-AB	35	GDC800-1200	253	MH612-616P2	84
BILB1-L	313	E1216-1616	35	GDR1200-1800	253	MH616P22	84
BILB308-309B1	313	E1216-1616-AB	35	GDS800	253	MH8-18	85
BILB308-309B1-L	313	E126-166	34	GEM300-302K2	288	MKF10	370
BLFL4-6D	153	E126-166-AB	34	GLD01	187	MKF22	370
BOP04	438	E128-168	34	GR01-03	438	MKFFH10	370
BPC800	247	E128-168-AB	34	GZ610-614	105	MKFFH22	370
BPED-PD	143	E2412-3212	35	HAL300T1	301	MKM10	371
BPFA2-3	146	E2416-3216	35	HAN01-3G	349	MKM22	371
BPR1200-1800	247	E3612-4812	35	HB1050-1650	205	MKMH10	371
BPS800	247	E3616-4816	35	HBL-1-3	191	MKMH22	371
BPSF2-4	149	EB10-D	217	HBSP1050-1650	205	ML3M-B	197
BROSF	151	EB18/CO	217	HEL50001-04	358	MMPN-W	143
BRU100C1	330	EB20/CO	217	HER300T1	327	MP12-18P2-3	79
BS	116, 117	EB24	213	HLCPU	183	MP14-16WL/R	80
BSH01-02	434	EBT1212-1616	213	HOL300T1-K	284	MP14-16WLP2-3	80
BUDDY-1/2	263	EBT1616-CO	213	HRM504C-K/SP	424	MP14-16WRP2-3	80
BUR	151	EBT2412	213	HRM509C/SP	424	MP14-18EL/R	81
C	144	EBT3216/CO	213	HS2010	421	MP16-18ELP2-3	81
CAD800LH-RH	187	ECR1200-1600	249	HS8301	344	MP16-18ERP2-3	81
CAS01-02	322	ED12-16DCT	39	ION-1	193	MP16-18P22-23	79
CAT300T1	334	ED12-16SCT	42	ISL300T1	295	MP16-18P33	79
CAV100C1	327	EDELSB	166	JEN300T1	321	MP3	142
CAV300T1	312	EDILSB	166	JH40-46	312, 390	MP608-616	78
CAV300T1-B/C	15	EDR1200-1600	249	JIV300	342, 343	MP612-616P2	78
CBX-1	17	ELS300K2	282	JIV301	342, 343	MP616P22	78
CBX-2	18	ENB500-C	203	JNS100C1	335	MP8-18	79
CBX-4	19	ENBLS	203	JNS300T1	302-303	MPC800	243
CBX-LBC1	19	ENBU-12	203	JUD03-06	430	MPC800-CO	245
CBX-LBS1	16	ENC01-02L/H-MF	458-461	JUN01-02	428	MPN3	142
CBX-S1	19	ENC01-03L/H	458-461	JX40-46	390	MPR1200-1800	243
CBX-SWS	19	ENC-MOD01-02H	458-461	JXERG0A-B	309, 390	MPS800	243
CC12-18S2-3	88	ENC-MOD01-02L	458-461	KAR300T1	284	MUS-POD02-K	359
CC14-18EL/R	89	ENCOP-POD02-06	466	KCY400T1	381	NAN300T1	325
CC16-18EL2-3	89	ENC-POD02-06	468	KUK10	366	NAP300T1	291
CC16-18ER2-3	89	ENC-TAB01-02	458-461	KUK22	366	NBO100C1	331
CC16-18S22-23	88	ENDD1-4	194	KUKH10	367	NBO300T1	324
CC16-18S33	88	ENT16-16/CO	203	KUKH22	367	NEB1-3	190
CC8-18S	88	ENT32-16/CO	203	LB1050-1650	205	NECPU	184
CEL50001-2	436	ENT48-16/CO	203	LBSP1050-1650	205	NERA-D	454
CF2-3FP	110	EPR1200-1600	249	LCK4-6D	120	NERA-PU	454
CFHBC	111	ER14168-16168	34	LCY01-4	400, 401	NERA-Q	454
CFHCU	111	ER1488-1688	34	LDMARM	180	NERA-S	454
CFL1200-1800	235	ER28168-32168	34	LF2-4	119	NIN300T1-K	305
CFL1600S	235	ER2888-3288	35	LH40-46	394	ODE300T1	320
CFLBC	111	ERB24/CO	217	LIA01-02	351	OP500/501	374
CFLCU	111	ES800-1800S	158	LK22-28	165	OP600/601	374
CFMBC	111	ES800-1800W	159	LK42-48	165	OP700/701	374
CFMCU	111	ESC450	261	LON50001	353	OPH600/601	374
CFTBC	111	ESC800	261	LSMARM	180	ORN300T1	299
CFTCU	111	ESRB	166	LUC300T1	311	OSL50001-3	440
CH12-18S2-3	92	ESS100S2	333	LUMB-CUSH	442	OTIS01-03	432
CH16-18S22-23	92	ETN10-12C	221	LUX50001-2	354	OTIS01-CT	432
CH16-18S33	92	ETN10-12-CO	221	LYR3000T1-K	282	OTIS05	432
CH2012	421						
CH8-18S	92						

P	PAL300K2	321	RU8-16D	268	STE1216-1616-AB	37	TOT100C1	335
	PAR1100	260	RU8-16H	269	STE2412-3212	37	TOT300T1	304
	PAS500	260	RU8GS	269	STE2416-3216	37	TR86	58
	PAX300T1-K	285	RUC8D	268	STE3612-4812	37	TRD14-18	58
	PC126-B/E/R/S/U	174	RUC8H	269	STE3616-4816	37	TUB100-104C1	404-407
	PC2412-B/E/R/S/U	174	RUHC18D	268	STR501-504/SP	422	TUB200-204C1	404-407
	PCC800	251	RUHC8H	269	STR601-604/SP	422	TUB300-304C1	404-407
	PCR1200-1800	251	S	S2F	SUP100-102	410-413	TUR1200	258
	PCS800	251		SA-LINK-KIT	SUP200-202	410-413	TUS300T1	298
	PDC800	251		SBU10-22	SUP300-302	410-413	TUS300T1-B/K	310
	PDR1200-1800	251		SC00	SWY300K2	285	TUS300T1-BLK	324
	PDS800	251		SCAT-CUSH	SX40-46	386	TYL-300T1	303, 304
	PED-PD	113		SCO1216-1616	SKERGOA-B	308, 386	TUS500	258
	PH-1-2	192		SCO1216-1616-AB	T608-618	58	TVLOCK	237
	PKS003	177		SCO128-168	T8-18	58	TVS300T1	298
	PMC001	186		SCO128-168-AB	TAM50001-4	420	TWL14-16	59
	PMC002	186		SCO2416-3216	TAOT1200-1800	205	TWR14-16	59
	PMC003	186		SCO3616-4816	TAU40002-4-PB/PK	341	UCS2-2	106
	POR300T1	308		SFL1200-1800	TAU40002-7	340, 416	UCS3-2	106
	PPC800	251		SFL1600S	TAU40005-7-W	342	UNA50001	355
	PPR1200-1800	251		SFU100-102	TAULINK	341	UNSCBR	166
	PPS800	251		SFU200-202	TAUMA	341	V100-102	314
	PRA50001-02	339		SFU300-302	TAUMK-W	341	V200-202	315
	PRM300	338		SH40-46	TAU-P-B2-4/T	417	V8-V18	62
	PS12-24-LT	175		SHAW	TAU-U-B2-4/T	417	VB800-1800	160
	PS12-SN	175		SHL300-301K2	TB10-12C	219	VC00-01	391
	PS25-EG	175		SIE50001	TB10-D	219	VD20-22	391
	PTAOT1200-1800	205		SIE50009	TB18-24	219	VEL14-18	62
	PTN-1T-2S	192		SIR305-K-K	TB18-24-CO	219	VER14-18	62
	PWH-25-50	173		SIS450	TBEL14-18	59	VEK8-18	62
	PWR-25-50	173		SIS800	TBER14-18	59	VFT1	165
	PWS-25-50	173		SM40-46	TDEL14-18	59	VG40-00	383
	PWT-25-50	173		SMB100-102	TDER14-18	59	VH10-12	391
	PX-1-3	194		SMB200-202	TDH5-P	27	VH20-22	391
	QVO40005	343		SMB300-302	TG16-20	122	VM10-12	391
	R1090-2140TC	118		SMD40-44	TGDMARM	181	VMD20-22	391
	R1440-2140COM	117		SND300K2	TGF100-200	378, 379	VMH10-12	295, 391
	R1440-2140OP	117		SOF300T1	TGF10-12	378, 379	VRV501-4C	419
	R2-3F	113		SOL100C1	TGF20-22	378, 379	VWL14-16	62
	R2-3M	113		SOL300T1	TGFH12	378, 379	VWR14-16	62
	R25DH6-8	114		SOM300T1	TGFH22	378, 379	WB0800-1400	185
	R25EP8	114		SP610-614-P	TGM100-200	378, 379	WDET	267
	R740-2140	116		SPB100-102	TGM10-12	378, 379	WKCD181	154
	R740-2140D	116		SPB200-202	TGM20-22	378, 379	WKCL181	154
	RBX-1	14		SPB300-302	TGSMARM	181	WKPL181	154
	RDC800	255		SPB-B2-3/T	TH10-12	394	WLIGHT	267
	RDS800	255		SPB-B4/T	TH20-22	394	WPL	267
	REM-HS/A	425		SPTA12-16	THL-1-2	195	WPLS-D	120
	RHE300T1-K	305		ST8-20	THS8-18	58	WRD14-16	266
	RON300T1	292		STA12-24	TK610-614P	102	YAS300T1-K	289
	ROS01-02-HS/A	425		STE1212-1612	TMP	113	YEAS50001-07	444
	ROSP	185		STE1212-1612-AB	TNMP	113	ZAL300T1-K	291
	RT12	217		STE1216-1616	TO16-20	122	ZEU200-300K2	319, 320

Index | Series

ACOUSTIC CEILING RAFTS	175	DESK TOP SCREENS	158-160	LIANA	351	RONAN	292
ACOUSTIC PANELS	174	DIONE	293	LONDON	353	ROSCOE	425
ACOUSTIC SCREENS	172, 177	DUFFY	299	LUCCA	311	SANDRO	289
ACOUSTIC SOLO BOOTH	176	ECLIPSE	194	LUNA	180	SANTANA	408-419
ACOUSTIC WALL TILES	173	ELEV8 ² MONO	22-27	LUXE	354	SCREENS - DESK TOP	158-161
ADAPT	32-39, 212-213	ELEV8 ² TOUCH	28-31, 201-211	LYRA	282	SCREENS - FLOOR	164
AERO	195	ELISE	282	LYRIC	448-451	SENZA	293, 308, 311, 384-387
ALBAN	452, 473	ENABLE	202-203	MAESTRO 25 BENCH	52-55	SHELBY	283
ALPHA	348	ENCORE ²	458-461	MAESTRO 25 CABLE MAN	64-69	SHOUT	434
ALTINO	294, 392-395	EROS	248-249	MAESTRO 25 CANTILEVER	70-75	SIANO	259
ALTO	446-447	ESSEN	333	MAESTRO 25 H-FRAME	82-85	SIENNA	345-346
ALUMINIUM SCREENS	162-163	ESTE	261-262	MAESTRO 25 PANEL END	76-81	SIRENA	290
ANSON	94-99, 224-225	ETERNAL	220-221	MARTINEZ	323	SLAB	206-207
ARCADE	292	EVA	301	MEAVY	442-443	SOFIA	310
ARROW HEAD	216-217	FLEXI 25	238-239	MELODY	356	SOLARIS	300, 334
ASCONA	327	FLORENCE	318	MIKU	368-371	SOMERSET	325
ATLAS	319	FLUX LOCKERS	134-138	MONZA	242-245	SORA	184
AURORA	302	FLUX SHELIVING	128-133	MUSE	359	SPARTA	103
AVA	338	FOLDING LEG	232-235	NANTES	325	STEEL STORAGE	140-155
BARI	323, 326, 331, 332	FRANKLIN	318	NAPIER	291	STRUT	422
BENOTTO	357	FUNDAMENTAL	421	NEBULA	190	SWAY	285
BILBAO	313	FUZE	40-45, 214-215	NEON	182	SYSTEMS STORAGE	121-123
BISLEY	140-155	GECKO	344	NERA	454-457	TAMAR	420
BRESCIA	246-247	GEMINI	288	NINA	305	TAURUS	340-342, 416-20
BRUGES	330	GENOA	252-253	NOBLE	324, 331	TEGAN	376-379
BUDDY	263	GIZA	105	ODESSA	320	THOLUS	195
CAIRO	104	GROOVE	438-439	ORION	299	TIKAL	102
CATANIA	322	HALE	301	ORTHO PRO	372-375	TOTO	304, 335
CAVALIER	312, 327, 334	HALO	183	OSLO	440-441	TR10	56-59
CELESTRA	436	HANNA	349	OTIS	432-433	TRAVIS	298
CHATBOX	15-19	HARMONY	424	OTTO	204-205	TRITON	180
CHORD	300	HELSINKI	358	PALERMO	321	TRUMPET BASE	218-219
CHROMA	191	HERTFORD	327	PARMA	260	TUBA	402-407
CODA	339	HOLDEN	284	PAXTON	285	TURIN	258
CONNEX 2	46-51	HUBBLE	191	PHASE	192	TUSCAN	298, 310, 324
CONTRACT 25	86-93	INCA	193	PISA	250-251	TYLER	303-304
CONTRACT 25 STORAGE	110-113	ION	193	PIXEL	194	UNA	355
CONTRACT FLIPTOP	230-232	ISLA	295	PORTER	308	UNIVERSAL PEDESTALS	112-114
CORBAY	352	JENSEN	321	PRAGUE	339	UNIVERSAL STORAGE	115-119
CORNWALL	309	JIVE	342-343	PREMA	338	UNIVERSAL LOCKERS	120
CUBE	106-107	JONAS	302-303, 335	PRIVA SCREENS	161	VANTAGE	314-315
CURVA	290	JOTA	309, 312, 388-391	PROTON	192	VERVE	419
DART	420	JUDE	430-431	QUAVO	343	VIRGIL	382-383
DECCO	352	JUNA	428-429	RADIAL LEG	236-237	VIVO	60-63
DELUXE FLIPTOP	228-229	KACEY	380-381	REMY	425	WELCOME	266-267
DELUXE STORAGE	124-125	KARA	284	RETREAT BOX	14	YASMIN	289
DENVER	268-271	KURA	364-367	RHEA	305	YEALM	444-445
DERBY	322, 331	LACEY	398-401	ROMA	254-255	ZALA	291
						ZEUS	319-320



dams 

Dams Furniture Ltd
Charley Wood Road,
Knowsley Industrial Park,
Knowsley,
Merseyside
L33 7SG

0151 548 7111
sales@dams.com
www.dams.com