

Alban - Meeting Booth

ALB02 - ALB04 - ALB06



ASSEMBLY INSTRUCTIONS

Tilly
Meeting Booths

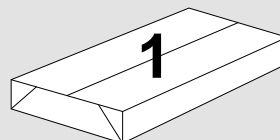

Pack 1:
2x Sofa Units

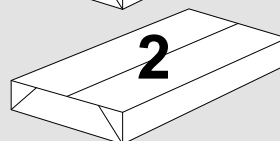

Pack 2:
1x Linking Panel

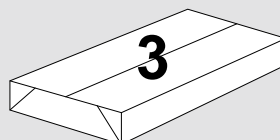

Pack 3:
1x Top Pack &
Fitting Kit

TOOLS REQUIRED
FOR ASSEMBLY

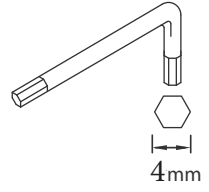
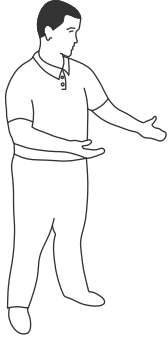

DONT STRUGGLE
2 MAN LIFT

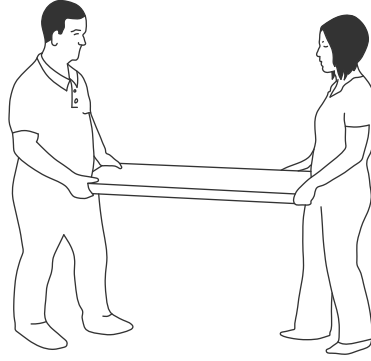
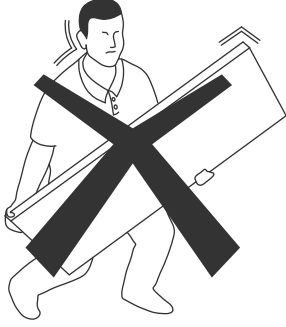

ALWAYS HANDLE
ITEMS WITH CARE

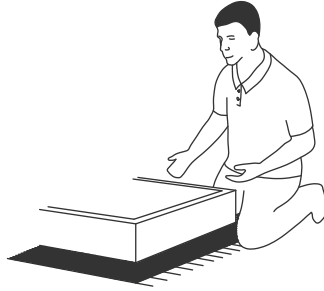
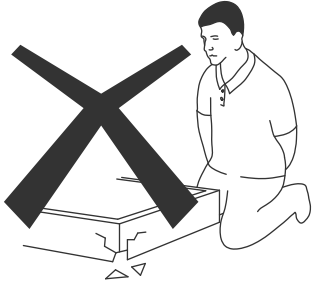

IF UNSURE CALL
FOR ASSISTANCE

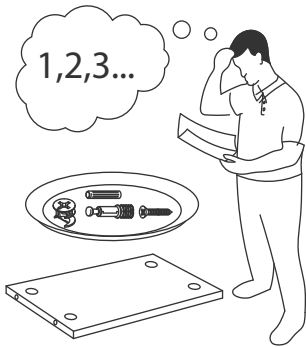

KEEP FITTINGS AWAY
FROM CHILDREN

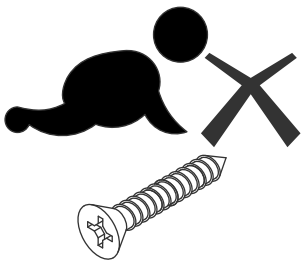



Please check that you have all the parts

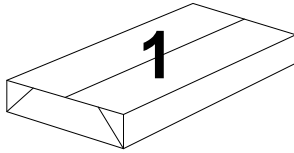

PACK 1:
2 x Sofas

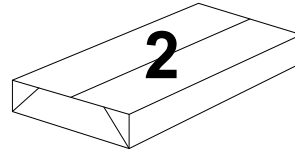

PACK 2:
1 x Link Panel

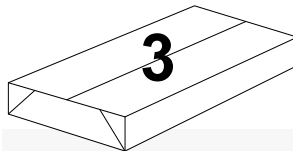
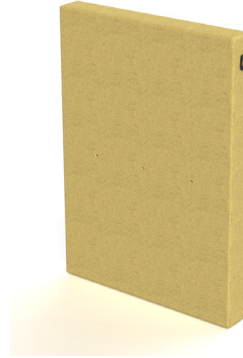

PACK 3:
1 x Top Pack & Fitting Kit

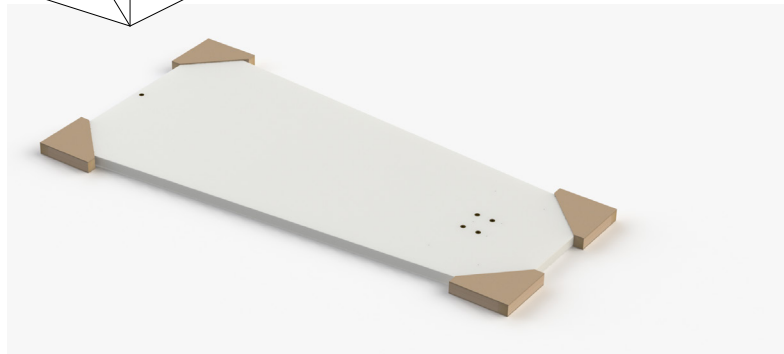

Please check that you have all the fittings

FITTINGS SUPPLIED



Connector Bolt - M6

Size **PCS**
50mm **3**
30mm **3**



Connector Bolt - M6

Size **PCS**
20mm **8**



Top Fixing Bracket

Size **PCS**
500 x 50mm **1**



Link Fixing Bracket

Size **PCS**
120 x 30mm **2**

ALBAN MEETING BOOTH ASSEMBLY

1

Step 1

Unpack your new Alban booth seating unit and please recycle all packaging.



2

Step 2

Locate and attach the leg aligning the holes located as shown using the M6 x 20mm bolts.

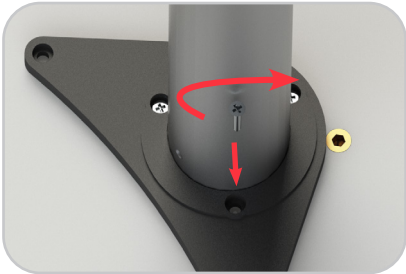

3

Step 3

Locate the infill panel to the sofa units aligning the button fixture with it's housing.

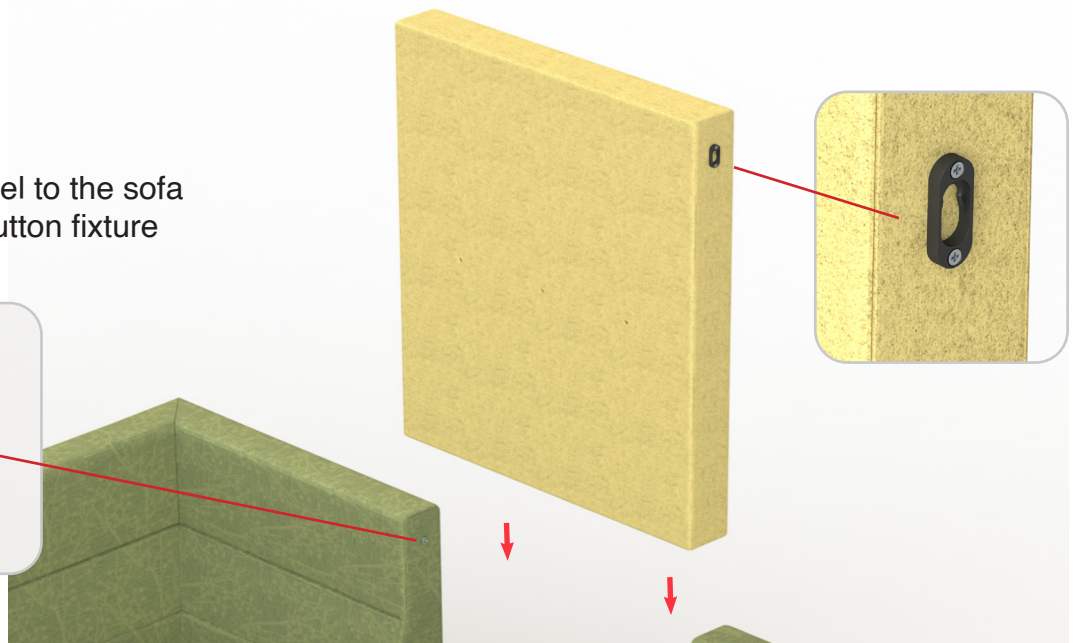

4

Step 4

Locate the brackets to the fixing holes and attach using the M6 x 20mm bolts as shown.

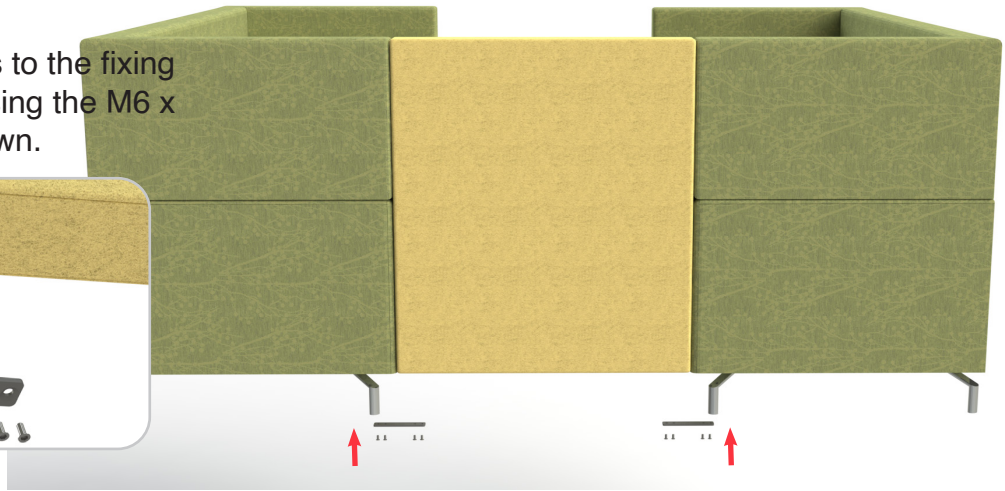
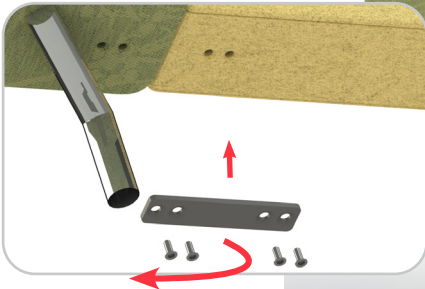

5

Step 5

Attach the M6 x 50mm bolts as shown to secure the brackets to the infill panel.

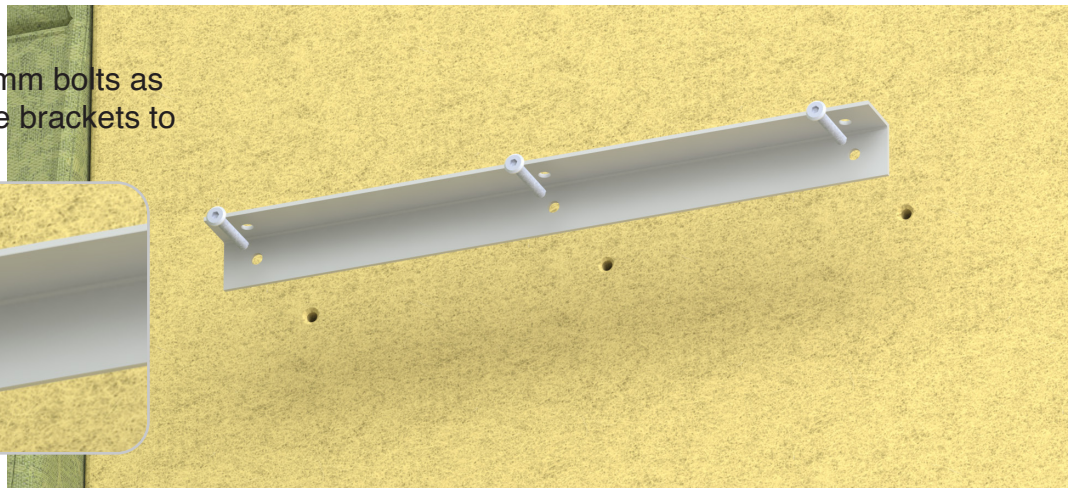
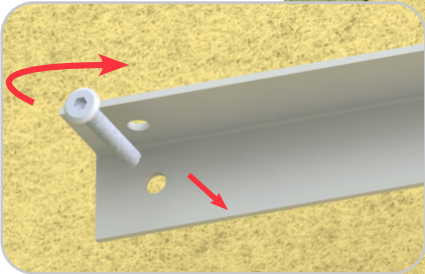

6

Step 6

Attach the M6 x 30mm bolts as shown to secure the brackets to the top.

