

Encore - Divider Unit

ENC-MOD01L-PM - ENC-MOD01H-PM

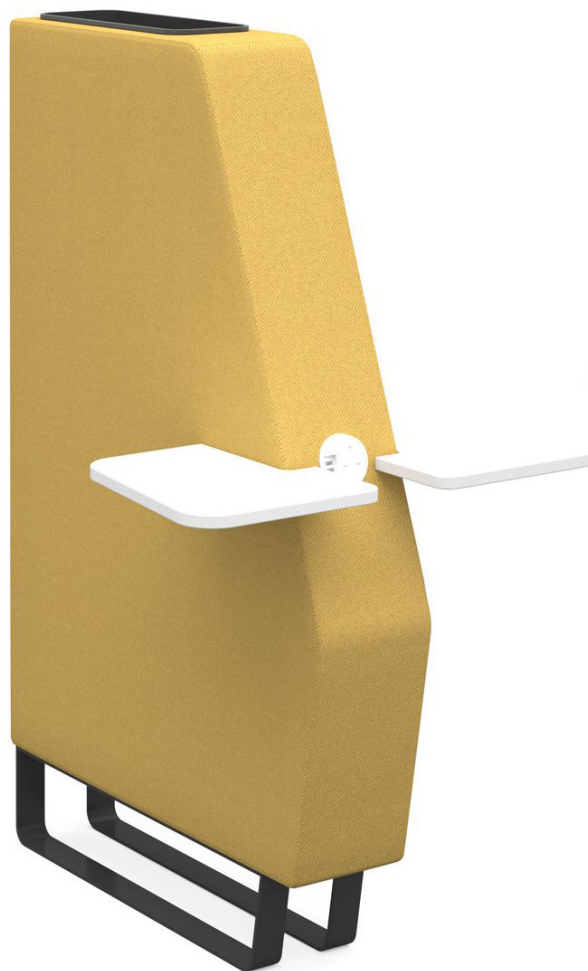

ASSEMBLY INSTRUCTIONS

Encore
Divider Units

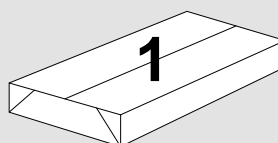

Pack 1:
1x Divider Unit

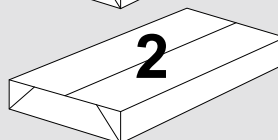

Pack 2:
1x Shelf Panels

TOOLS REQUIRED
FOR ASSEMBLY

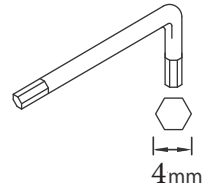
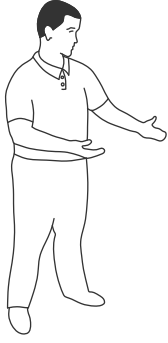

DONT STRUGGLE
2 MAN LIFT

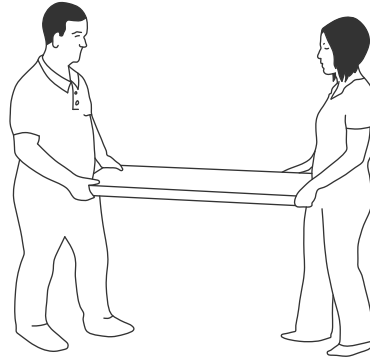
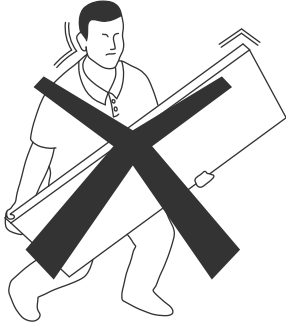

ALWAYS HANDLE
ITEMS WITH CARE

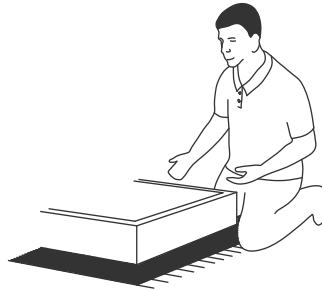
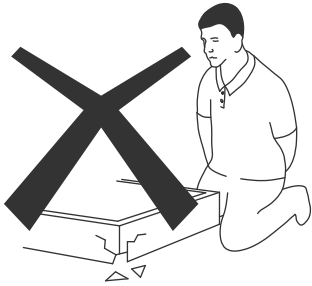

IF UNSURE CALL
FOR ASSISTANCE

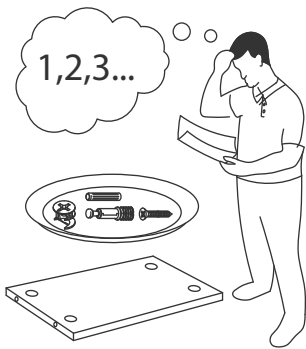

KEEP FITTINGS AWAY
FROM CHILDREN

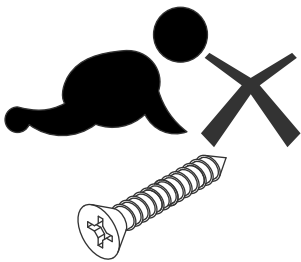



Please check that you have all the parts

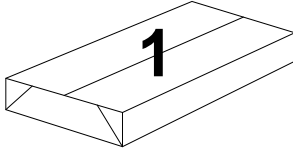

PACK 1:
2 x Divider Unit

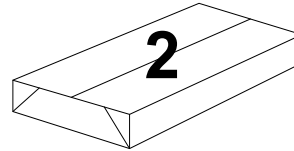

PACK 2:
2 x Shelf Panels

800 x 900mm = ENC-MOD01L-PM
800 x 1300mm = ENC-MOD01H-PM

300 x 400mm

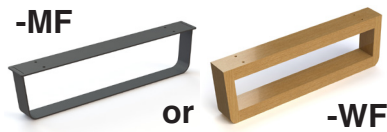
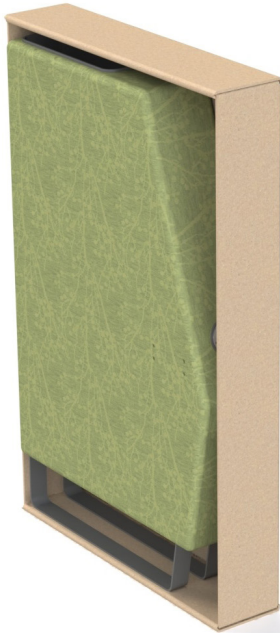

Please check that you have all the fittings

FITTINGS SUPPLIED



Connector Bolt - M6

Size 50mm **PCS 8**



Connector Bolt - M6

Size 30mm **PCS 8**



Top Fixing Bracket

Size 120 x 120mm **PCS 4**

TILLY MEETING BOOTH ASSEMBLY

1

Step 1

Unpack your new Encore divider unit and please recycle all packaging.



2

Step 2

Locate and attach the shelf brackets aligning the holes located as shown using the M6 x 50mm bolts.

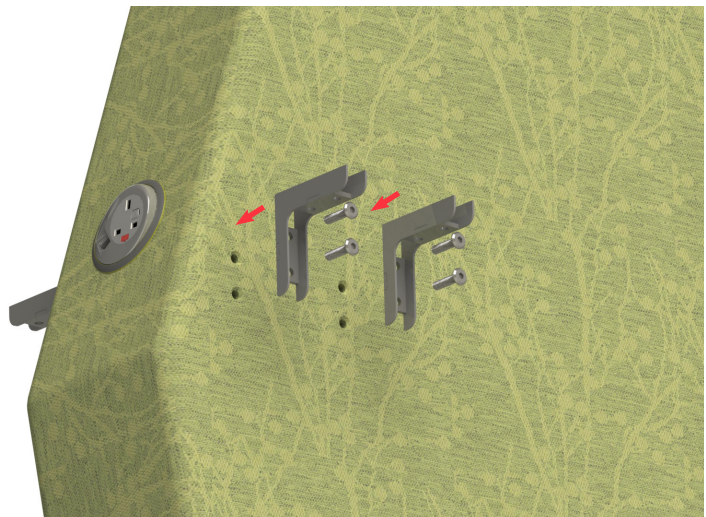
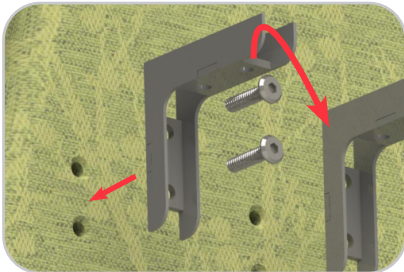

3

Step 3

Locate and attach the shelf panels aligning the holes located as shown using the M6 x 30mm bolts.

